

CONTINUOUS HINGE, TYPE 4X

INDUSTRY STANDARDS

Mounting brackets required to meet UL/CSA external mounting requirements.

UL 508A Listed; Type 4, 4X, 12, 13; File No. E61997
 cUL Listed per CSA C22.2 No 94; Type 4, 4X, 12, 13; File No. E61997
 Enclosure flammability evaluated per UL 508A
 Window flammability evaluated per UL 508A

NEMA/EEMAC Type 4, 4X, 12, 13
 CSA File No. 42186: Type 4, 4X, 12, 13
 IEC 60529, IP66

APPLICATION

The efficient design and simple construction of these enclosures make them durable in corrosive environments, yet aesthetically pleasing. Corner latches provide unobstructed access. The continuous hinge provides a secure seal, and double latching creates added security.

SPECIFICATIONS

- Compression-molded fiberglass has outstanding chemical- and temperature-resistance qualities and exhibits excellent weatherability and physical properties
- Fiberglass is easily punched, drilled, filed or sawed
- Gasket assures water-tight and dust-tight seal
- Polyester mounting brackets and stainless steel attachment screws are provided with each enclosure
- Scratch-resistant polycarbonate windows are permanently bonded in place
- Molded-in-place threaded brass inserts and plated steel screws are provided for mounting optional panels and terminal block kits
- Removable hinged cover attached to body with Type 316 stainless steel hinge pin
- Screw-cover enclosures are secured with two captivated Type 316 stainless steel slotted cover screws
- Enclosures with quick-release latches have corrosion-resistant polyester latches located in corners that provide unobstructed access to enclosure
- Hinge pin and bail are corrosion-resistant Type 316 stainless steel
- Padlock provisions included in each latch
- Material is halogen free

FINISH

Standard fiberglass material finish is light-gray inside and out. Optional steel panels are painted white. Optional stainless steel, aluminum, conductive and composite panels are unpainted.

ACCESSORIES

See also Accessories.
 H2OMIT Vent Drains, Type 4X
 HOL-SEALERS Non-Metallic Hole Seals
 Panels for Junction Boxes
 Threaded Panel Extenders
 Quick-Release Latch Kit
 Swing-Out Panel Kit

MODIFICATION AND CUSTOMIZATION

Hoffman excels at modifying and customizing products to your specifications. Contact your local Hoffman sales office or distributor for complete information.

BULLETIN: A48

Standard Product **Solid Cover**

Catalog Number	AxBxC in./mm	Type	Steel Panel	Alum. Panel	Panel Size D x E in./mm	Mounting G x H in./mm	Overall L x W in./mm	F in./mm	J in./mm	K in./mm	O in./mm	P in./mm	Q in./mm	T in./mm	U in./mm
A664CHSCFG	6.00 x 6.00 x 4.00	Screw	A6P6	A6P6AL	4.88 x 4.88	6.94 x 4.00	6.50 x 6.50	3.45	3.25	1.00	4.25	4.25	5.64	0.12	5.64
	152 x 152 x 102	Cover			124 x 124	176 x 102	165 x 165	88	83	25	108	108	143	3	143
A664CHQRFG	6.00 x 6.00 x 4.00	Quick Release	A6P6	A6P6AL	4.88 x 4.88	6.94 x 4.00	6.50 x 6.50	3.45	3.25	1.00	4.25	4.25	5.64	0.12	5.64
	152 x 152 x 102	Release			124 x 124	176 x 102	165 x 165	88	83	25	108	108	143	3	143
A864CHSCFG	8.00 x 6.00 x 4.00	Screw	A8P6	A8P6AL	6.75 x 4.88	8.94 x 4.00	8.50 x 6.50	3.45	3.25	1.00	4.25	6.25	7.64	0.12	5.64
	203 x 152 x 102	Cover			171 x 124	227 x 102	216 x 165	88	83	25	108	159	194	3	143
A864CHQRFG	8.00 x 6.00 x 4.00	Quick Release	A8P6	A8P6AL	6.75 x 4.88	8.94 x 4.00	8.50 x 6.50	3.45	3.25	1.00	4.25	6.25	7.64	0.12	5.64
	203 x 152 x 102	Release			171 x 124	227 x 102	216 x 165	88	83	25	108	159	194	3	143
A1086CHSCFG	10.00 x 8.00 x 6.00	Screw	A10P8	A10P8AL	8.75 x 6.88	10.94 x 6.00	10.50 x 8.50	5.45	4.94	1.31	6.25	8.25	9.61	0.12	7.61
	254 x 203 x 152	Cover			222 x 175	278 x 152	267 x 216	138	125	33	159	210	244	3	193
A1086CHQRFG	10.00 x 8.00 x 6.00	Quick Release	A10P8	A10P8AL	8.75 x 6.88	10.94 x 6.00	10.50 x 8.50	5.45	4.94	1.31	6.25	8.25	9.61	0.12	7.61
	254 x 203 x 152	Release			222 x 175	278 x 152	267 x 216	138	125	33	159	210	244	3	193
A12106CHSCFG	12.00 x 10.00 x 6.00	Screw	A12P10	A12P10AL	10.75 x 8.88	12.94 x 8.00	12.50 x 10.50	5.45	4.69	1.56	8.25	10.25	11.58	0.12	9.58
	305 x 254 x 152	Cover			273 x 226	329 x 203	318 x 267	138	119	40	210	260	294	3	243
A12106CHQRFG	12.00 x 10.00 x 6.00	Quick Release	A12P10	A12P10AL	10.75 x 8.88	12.94 x 8.00	12.50 x 10.50	5.45	4.69	1.56	8.25	10.25	11.58	0.12	9.58
	305 x 254 x 152	Release			273 x 226	329 x 203	318 x 267	138	119	40	210	260	294	3	243
A14128CHSCFG	14.00 x 12.00 x 8.00	Screw	A14P12	A14P12AL	12.75 x 10.88	14.94 x 10.00	14.55 x 12.55	7.45	6.50	1.81	10.25	12.25	13.59	0.15	11.59
	356 x 305 x 203	Cover			324 x 276	379 x 254	370 x 319	189	165	46	260	311	345	4	294
A14128CHQRFG	14.00 x 12.00 x 8.00	Quick Release	A14P12	A14P12AL	12.75 x 10.88	14.94 x 10.00	14.55 x 12.55	7.45	6.50	1.81	10.25	12.25	13.59	0.15	11.59
	356 x 305 x 203	Release			324 x 276	379 x 254	370 x 319	189	165	46	260	311	345	4	294
A16148CHSCFG	16.00 x 14.00 x 8.00	Screw	A16P14	A16P14AL	14.75 x 12.88	16.94 x 12.00	16.55 x 14.55	7.45	6.23	2.08	12.25	14.25	15.56	0.15	13.56
	406 x 356 x 203	Cover			375 x 327	430 x 305	420 x 370	189	158	53	311	362	395	4	344
A16148CHQRFG	16.00 x 14.00 x 8.00	Quick Release	A16P14	A16P14AL	14.75 x 12.88	16.94 x 12.00	16.55 x 14.55	7.45	6.23	2.08	12.25	14.25	15.56	0.15	13.56
	406 x 356 x 203	Release			375 x 327	430 x 305	420 x 370	189	158	53	311	362	395	4	344
A181610CHSCFG	18.00 x 16.00 x 10.00	Screw	A18P16	A18P16AL	16.75 x 14.88	18.94 x 14.00	18.58 x 16.58	9.45	7.66	2.66	14.25	16.25	17.53	0.16	15.53
	457 x 406 x 254	Cover			425 x 378	481 x 356	472 x 421	240	195	68	362	413	445	4	394
A181610CHQRFG	18.00 x 16.00 x 10.00	Quick Release	A18P16	A18P16AL	16.75 x 14.88	18.94 x 14.00	18.58 x 16.58	9.45	7.66	2.66	14.25	16.25	17.53	0.16	15.53
	457 x 406 x 254	Release			425 x 378	481 x 356	472 x 421	240	195	68	362	413	445	4	394
A201610CHSCFG	20.00 x 16.00 x 10.00	Screw	A20P16J	A20P16JAL	18.75x14.88	20.94x14.00	20.58x16.58	9.45	7.66	2.66	13.81	17.81	19.64	0.16	15.64
	508 x 407 x 254	Cover			476x378	532x356	523x421	240	195	68	351	452	499	4	397
A201610CHQRFG	20.00 x 16.00 x 10.00	Quick Release	A20P16J	A20P16JAL	18.75x14.88	20.94x14.00	20.58x16.58	9.45	7.66	2.66	13.81	17.81	19.64	0.16	15.64
	508 x 407 x 254	Release			476x378	532x356	523x421	240	195	68	351	452	499	4	397

Purchase panels separately. Optional stainless steel, aluminum, conductive and composite material panels available for most sizes.

Standard Product **Window Cover**

Catalog Number	AxBxC in./mm	Type	Steel Panel	Alum. Panel	Panel Size D x E in./mm	Mounting G x H in./mm	Overall L x W in./mm	F in./mm	J in./mm	K in./mm	M in./mm	N in./mm	O in./mm	P in./mm	Q in./mm	T in./mm	U in./mm
A664CHSCFGW	6.00 x 6.00 x 4.00	Screw	A6P6	A6P6AL	4.88 x 4.88	6.94 x 4.00	6.50 x 6.50	3.45	3.25	1.00	4.25	4.25	4.25	4.25	5.64	0.12	5.64
	152 x 152 x 102	Cover			124 x 124	176 x 102	165 x 165	88	83	25	108	108	108	108	143	3	143
A664CHQRFGW	6.00 x 6.00 x 4.00	Quick Release	A6P6	A6P6AL	4.88 x 4.88	6.94 x 4.00	6.50 x 6.50	3.45	3.25	1.00	4.25	4.25	4.25	4.25	5.64	0.12	5.64
	152 x 152 x 102	Release			124 x 124	176 x 102	165 x 165	88	83	25	108	108	108	108	143	3	143
A864CHSCFGW	8.00 x 6.00 x 4.00	Screw	A8P6	A8P6AL	6.75 x 4.88	8.94 x 4.00	8.50 x 6.50	3.45	3.25	1.00	6.25	4.25	6.25	6.25	7.64	0.12	5.64
	203 x 152 x 102	Cover			171 x 124	227 x 102	216 x 165	88	83	25	159	108	108	159	194	3	143
A864CHQRFGW	8.00 x 6.00 x 4.00	Quick Release	A8P6	A8P6AL	6.75 x 4.88	8.94 x 4.00	8.50 x 6.50	3.45	3.25	1.00	6.25	4.25	6.25	6.25	7.64	0.12	5.64
	203 x 152 x 102	Release			171 x 124	227 x 102	216 x 165	88	83	25	159	108	108	159	194	3	143
A1086CHSCFGW	10.00 x 8.00 x 6.00	Screw	A10P8	A10P8AL	8.75 x 6.88	10.94 x 6.00	10.50 x 8.50	5.45	4.94	1.31	8.25	6.25	6.25	8.25	9.61	0.12	7.61
	254 x 203 x 152	Cover			222 x 175	278 x 152	267 x 216	138	125	33	210	159	159	210	244	3	193
A1086CHQRFGW	10.00 x 8.00 x 6.00	Quick Release	A10P8	A10P8AL	8.75 x 6.88	10.94 x 6.00	10.50 x 8.50	5.45	4.94	1.31	8.25	6.25	6.25	8.25	9.61	0.12	7.61
	254 x 203 x 152	Release			222 x 175	278 x 152	267 x 216	138	125	33	210	159	159	210	244	3	193
A12106CHSCFGW	12.00 x 10.00 x 6.00	Screw	A12P10	A12P10AL	10.75 x 8.88	12.94 x 8.00	12.50 x 10.50	5.45	4.69	1.56	10.25	8.25	8.25	10.25	11.58	0.12	9.58
	305 x 254 x 152	Cover			273 x 226	329 x 203	318 x 267	138	119	40	260	210	210	260	294	3	243
A12106CHQRFGW	12.00 x 10.00 x 6.00	Quick Release	A12P10	A12P10AL	10.75 x 8.88	12.94 x 8.00	12.50 x 10.50	5.45	4.69	1.56	10.25	8.25	8.25	10.25	11.58	0.12	9.58
	305 x 254 x 152	Release			273 x 226	329 x 203	318 x 267	138	119	40	260	210	210	260	294	3	243
A14128CHSCFGW	14.00 x 12.00 x 8.00	Screw	A14P12	A14P12AL	12.75 x 10.88	14.94 x 10.00	14.55 x 12.55	7.45	6.50	1.81	12.25	10.25	10.25	12.25	13.59	0.15	11.59
	356 x 305 x 203	Cover			324 x 276	379 x 254	370 x 319	189	165	46	311	260	260	311	345	4	294
A14128CHQRFGW	14.00 x 12.00 x 8.00	Quick Release	A14P12	A14P12AL	12.75 x 10.88	14.94 x 10.00	14.55 x 12.55	7.45	6.50	1.81	12.25	10.25	10.25	12.25	13.59	0.15	11.59
	356 x 305 x 203	Release			324 x 276	379 x 254	370 x 319	189	165	46	311	260	260	311	345	4	294
A16148CHSCFGW	16.00 x 14.00 x 8.00	Screw	A16P14	A16P14AL	14.75 x 12.88	16.94 x 12.00	16.55 x 14.55	7.45	6.23	2.08	14.25	12.25	12.25	14.25	15.56	0.15	13.56
	406 x 356 x 203	Cover			375 x 327	430 x 305	420 x 370	189	158	53	362	311	311	362	395	4	344
A16148CHQRFGW	16.00 x 14.00 x 8.00	Quick Release	A16P14	A16P14AL	14.75 x 12.88	16.94 x 12.00	16.55 x 14.55	7.45	6.23	2.08	14.25	12.25	12.25	14.25	15.56	0.15	13.56
	406 x 356 x 203	Release			375 x 327	430 x 305	420 x 370	189	158	53	362	311	311	362	395	4	344
A181610CHSCFGW	18.00 x 16.00 x 10.00	Screw	A18P16	A18P16AL	16.75 x 14.88	18.94 x 14.00	18.58 x 16.58	9.45	7.66	2.66	16.25	14.25	14.25	16.25	17.53	0.16	15.53
	457 x 406 x 254	Cover			425 x 378	481 x 356	472 x 421	240	195	68	413	362	362	413	445	4	394
A181610CHQRFGW	18.00 x 16.00 x 10.00	Quick Release	A18P16	A18P16AL	16.75 x 14.88	18.94 x 14.00	18.58 x 16.58	9.45	7.66	2.69	16.25	14.25	14.25	16.25	17.53	0.16	15.53
	457 x 406 x 254	Release			425 x 378	481 x 356	472 x 421	240	195	68	413	362	362	413	445	4	394
A201610CHSCFGW	20.00 x 16.00 x 10.00	Screw	A20P16J	A20P16JAL	18.75x14.88	20.94x14.00	20.58x16.58	9.45	7.66	2.69	18.25	14.25	13.81	17.81	19.		

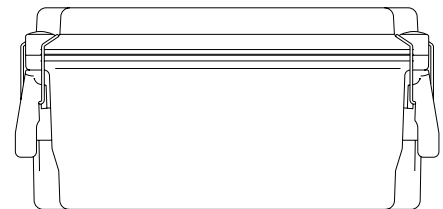
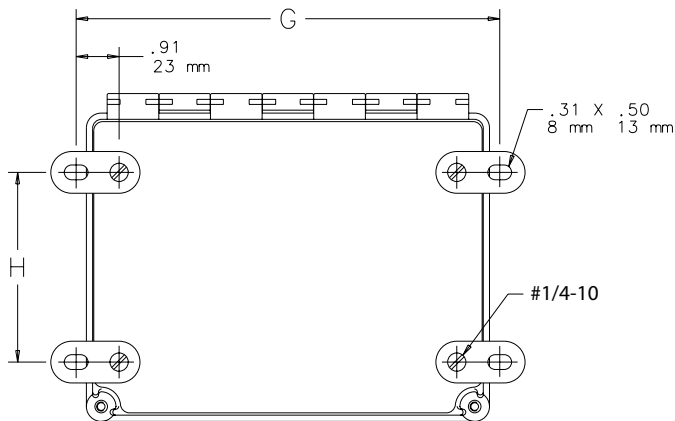
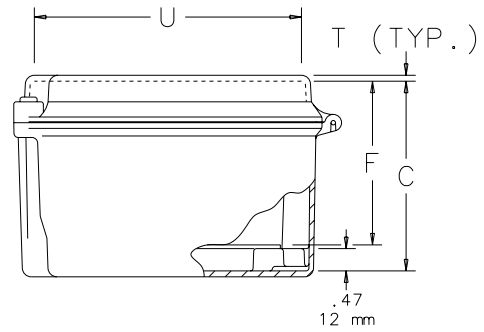
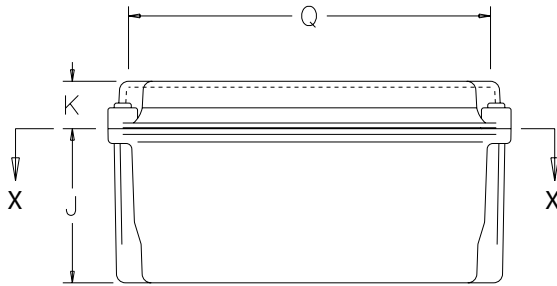
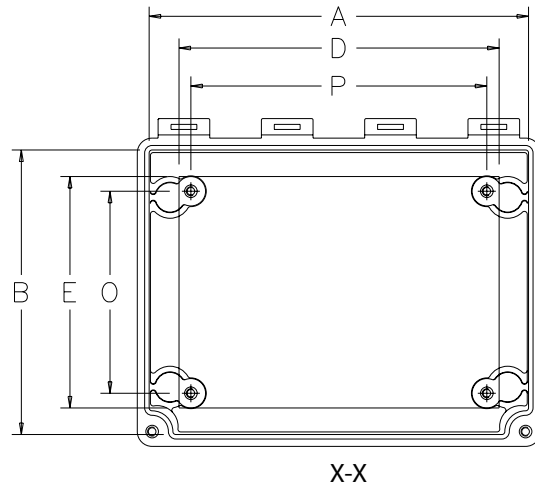
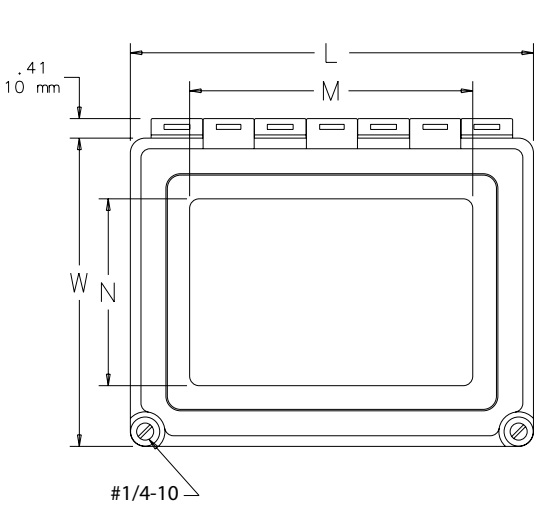

SIDE VIEW
(QUICK-RELEASE COVER ENCLOSURE)

C2567-C

QUICK-RELEASE LATCH KIT



Two fiberglass-reinforced gray polyester latches with 316L stainless steel bail and screw-hole plugs are included in each package. Supplied with Continuous Hinge, Type 4X enclosures and available for Fiberglass Hinged Cover WiFi Cabinet, Type 4X. Kit converts screw-cover enclosures to quick-release without modification. No tools needed to install. Padlocking provision is included.

BULLETIN: A48Y

Catalog Number	Description	Kit Qty.
AL48	Quick-Release Latch Kit	2

SWING-OUT PANEL KIT



The Swing-Out Panel Kit provides an attractive, cost-effective solution for installing front-mounted panels in Continuous Hinge, Type 4X, and Overlapping Cover, Type 4X enclosures. No drilling required.

BULLETIN: A48Y

Catalog Number	Fits Enclosure A x B (in.)	Fits Enclosure A x B (mm)
A6SPK6C	6.00 x 6.00	152 x 152
A8SPK6C	8.00 x 6.00	203 x 152
A10SPK8C	10.00 x 8.00	254 x 203
A12SPK10C	12.00 x 10.00	305 x 254
A16SPK14C	16.00 x 14.00	406 x 356
A18SPK16C	18.00 x 16.00	457 x 406
A14SPK12C	14.00 x 12.00	356 x 305

MOUNTING FOOT KIT



One-piece mounting foot kit consists of the necessary hardware to attach two fiberglass feet, molded from the same material as our A48 enclosure. This compression-molded fiberglass material has excellent chemical and temperature resistance and provides outstanding performance and durability in harsh environments. The mounting feet can be field installed on either the 18x16 or the 20x16 enclosure.

BULLETIN: A48

Catalog Number	Description	Kit Qty.
A48MFT16A	Mounting Foot Kit	2

X-ON Electronics

Largest Supplier of Electrical and Electronic Components

Click to view similar products for [Schroff](#) manufacturer:

Other Similar products are found below :

[13100103](#) [21006-945](#) [24827-024](#) [20848-487](#) [24566-125](#) [34561-198](#) [24563-157](#) [69001-733](#) [14575271](#) [14576145](#) [14575265](#) [20117-156](#)
[20817772](#) [20827088](#) [20846211](#) [20860229](#) [21100777](#) [23001069](#) [23022602](#) [23130082](#) [24571586](#) [24572066](#) [24822075](#) [26230-374](#) [30817-001](#)
[30825080](#) [23001021](#) [24563436](#) [24571303](#) [24572054](#) [21006959](#) [20848496](#) [20848-410](#) [20848-405](#) [20838-118](#) [20860-612](#) [10225-602](#) [10225-](#)
[613](#) [10828058](#) [28230-439-C](#) [24572-005](#) [24563-457](#) [24563-444](#) [20848-485](#) [20848-617](#) [21101-853](#) [10828071](#) [20848-587](#) [24563-134](#) [24563-](#)
[431](#)