

Shock-Safe Fuseholder, 5 x 20 / 6.3 x 32 mm, Slotted Cap, horizontal



Socket with Slotted Cap



Socket with Slotted Cap (grey)



Socket with Fingergrip Cap

250 VAC · 3.2 W / 10 A (VDE) · 600 VAC/VDC · 16 A (UL/CSA)

See below:  
[Approvals and Compliances](#)

**Description**

- Kinked or straight PCB-terminals
- Horizontal style

**Weblinks**

[pdf data sheet](#), [html datasheet](#), [General Product Information](#), [Distributor-Stock-Check](#), [Accessories](#), [Detailed request for product](#), [Microsite](#)

**Technical Data**

|                              |   |
|------------------------------|---|
| Shock-Safe Category          | PC2   |
| Fuse-Link                    | 5 x 20 / 6.3 x 32 mm  |
| Mounting                     | PCB   |
| Terminal                     | Solder THT  |
| Rated Voltage                | 250 VAC (VDE), 600 VAC/VDC (UL/CSA)   |
| Rated current                | 10 A (VDE), 16 A (UL/CSA)   |
| Rated Power Acceptance IEC   | 3.2 W / 10 A @ Ta 23 °C<br>2.5 W / 10 A for 5x20 mm fuse-link, see derating curves  |
| Degree of Protection         | IP40  |
| Protection Class             | Suitable for appliances with protection class I or II acc. to IEC 61140   |
| Admissible Ambient Air Temp. | -40 °C to 85 °C   |
| Climatic Category            | 40/085/21 acc. to IEC 60068-1   |
| Material: Socket             | Thermoplastic, black, UL 94V-0  |
| Material: Terminals          | Copper alloy, tin-plated  |
| Unit Weight                  | 5.1 g / 2.3 g   |
| Storage Conditions           | 0 °C to 60 °C, max. 70% r.h.  |
| Product Marking              |  Type, Rated Voltage, Rated current, Certification marks |

|                              |  |
|------------------------------|--|
| Soldering Methods            | Wave<br><a href="#">Soldering Profile</a>                  |
| Solderability                | 245 °C / 2 sec acc. to IEC 60068-2-20, Test Ta, method 1   |
| Resistance to Soldering Heat | 260 °C / 10 sec acc. to IEC 60068-2-20, Test Tb, method 1A |
| Solderability                | 245 °C / 2 sec acc. to IEC 60068-2-20, Test Ta, method 1   |
| Contact Resistance           | ≤ 10 mΩ at 100 mA acc. to IEC 60127-6                      |
| Dielectric Strength          | > 3 kV between life parts (50 Hz: 1 min)                   |
| Impulse Withstand Voltage    | > 4 kV between life parts                                  |
| Insulation Resistance        | > 10 MΩ between life parts (500 VDC: 1 min)                |
| Overvoltage Category         | III acc. to IEC 60664-1                                    |
| Pollution Degree             | 3 acc. to IEC 60664-1                                      |

**Approvals and Compliances**



Detailed information on product approvals, code requirements, usage instructions and detailed test conditions can be looked up in [Details about Approvals](#)

SCHURTER products are designed for use in industrial environments. They have approvals from independent testing bodies according to national and international standards. Products with specific characteristics and requirements such as required in the automotive sector according to IATF 16949, medical technology according to ISO 13485 or in the aerospace industry can be offered exclusively with customer-specific, individual agreements by SCHURTER.

**Approvals**



The approval mark is used by the testing authorities to certify compliance with the safety requirements placed on electronic products.

Approval Reference Type: FAU

| Approval Logo   | Certificates                  | Certification Body | Description                      |
|---|-------------------------------|--------------------|----------------------------------|
|  | <a href="#">VDE Approvals</a> | VDE                | VDE Certificate Number: 40045994 |
|  | <a href="#">UL Approvals</a>  | UL                 | UL File Number: E39328           |



**Product standards**

Product standards that are referenced

| Organization   | Design                | Standard             | Description  |
|--|-----------------------|----------------------|--|
|  | Designed according to | IEC 60127-6          | Miniature fuses. Part 6. Fuse-holders for miniature fuse-links |
|  | Designed according to | UL 4248-1            | Standard for Safety Fuseholders                                |
|  | Designed according to | CSA C22.2 no. 4248.1 | Industrial Control Equipment                                   |







**Application standards**

Application standards where the product can be used

| Organization   | Design                         | Standard       | Description  |
|--|--------------------------------|----------------|--|
|  | Designed for applications acc. | IEC/UL 62368-1 | Audio/video, information and communication technology equipment - Part 1: Safety requirements  |
|  | Designed for applications acc. | IEC 60335-1    | Safety of electrical appliances for household and similar purposes. Meets the requirements for appliances in unattended use. This includes the enhanced requirements of glow wire tests acc. to IEC 60695-2-11 or -12 & -13. |

**Compliances**

The product complies with following Guide Lines

| Identification   | Details  | Initiator   | Description   |
|--|--|-------------|---|
|    | <a href="#">CE declaration of conformity</a>   | SCHURTER AG | The CE marking declares that the product complies with the applicable requirements laid down in the harmonisation of Community legislation on its affixing in accordance with EU Regulation 765/2008. |
|    | <a href="#">UKCA declaration of conformity</a> | SCHURTER AG | The UKCA marking declares that the product complies with the applicable requirements laid down in the British Amendment of Regulation (EC) 765/2008.  |
|  | RoHS   | SCHURTER AG | Directive RoHS 2011/65/EU, Amendment (EU) 2015/863  |
|  | China RoHS                                     | SCHURTER AG | The law SJ / T 11363-2006 (China RoHS) has been in force since 1 March 2007. It is similar to the EU directive RoHS.  |
|  | REACH  | SCHURTER AG | On 1 June 2007, Regulation (EC) No 1907/2006 on the Registration, Evaluation, Authorization and Restriction of Chemicals 1 (abbreviated as "REACH") entered into force.                               |
|  | White Paper Glow wire test                     | SCHURTER AG | Meets the requirements of IEC 60335-1 for appliances in unattended use. This includes the enhanced requirements of glow wire tests acc. to IEC 60695-2-11 or -12 &-13.                                |

**Dimension [mm]**

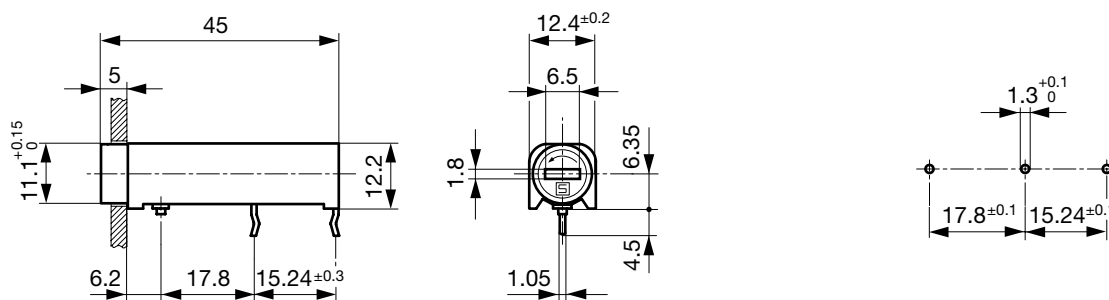

Variant 0031.3577

Drilling diagram

### Derating Curves

5x20 mm

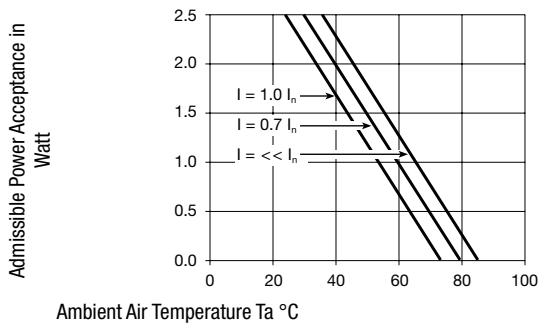

6.3x32 mm

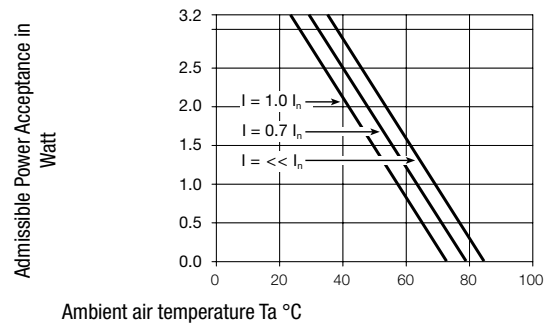

### All Variants

| Holder | Cap        | Fuse-Link           | Terminal | Degree of Protection | Colour Cap | Remark                | Comment | Order Number |
|--------|------------|---------------------|----------|----------------------|------------|-----------------------|---------|--------------|
| ●      | -          | 5 x 20 / 6.3 x 32mm | straight | IP40                 | -          | -                     | -       | 0031.3573    |
| ●      | -          | 5 x 20 / 6.3 x 32mm | kinked   | IP40                 | -          | -                     | -       | 0031.3577    |
| ●      | slotted    | 6.3 x 32mm          | kinked   | IP40                 | grey       | 0031.3577 + 0031.1666 | -       | 0031.3581    |
| ●      | Fingergrip | 6.3 x 32mm          | kinked   | IP40                 | -          | 0031.3577 + 0031.1667 | -       | 0031.3583    |
| ●      | slotted    | 5 x 20mm            | kinked   | IP40                 | -          | 0031.3577 + 0031.1663 | -       | 0031.3571    |
| ●      | Fingergrip | 5 x 20mm            | kinked   | IP40                 | -          | 0031.3577 + 0031.1741 | -       | 0031.3584    |

Most Popular.

Availability for all products can be searched real-time: <https://www.schurter.com/en/Stock-Check/Stock-Check-SCHURTER>

### Packaging Unit

Bulk (100 pcs.)

### Required Accessory

#### Description



Fingergrip FEU, FAU, FAC  
 Caps Fingergrip for Holder FEU, FAU, FAC



Caps to FEU, FAU, FAC  
 Caps to Holder FEU, FEU (Med), FAU, FAC

## X-ON Electronics

Largest Supplier of Electrical and Electronic Components

*Click to view similar products for [Fuse Holder](#) category:*

*Click to view products by [Schurter](#) manufacturer:*

Other Similar products are found below :

[570-290-741P40](#) [570-290-751P40](#) [020417G](#) [020418E](#) [6R30A1B](#) [F600A3B](#) [80910030](#) [8601.2020](#) [G15A2SPQ](#) [9-3557-GP REV A](#) [HDJ-B](#)  
[R6J30A3S](#) [HFH-1](#) [RF30A2B](#) [RF30A3SP](#) [15600-08-10](#) [BK/FHN19G](#) [BK/HHM](#) [BK/HKP-CCHH](#) [BK/HKP-JJ](#) [BK/HTJ-LES-FUSE](#) [HMG-](#)  
[241](#) [HTJ-LES-FUSE](#) [C4044-1](#) [2086-1](#) [2193](#) [2602](#) [2650](#) [178.000100](#) [FHN31G1](#) [T30A2B](#) [G4PB8](#) [2660](#) [2799](#) [CQ-209V](#) [HKP-CCHH](#)  
[R6F30A2S](#) [341001A](#) [345621A](#) [CVRMCC](#) [4202](#) [4407](#) [4408](#) [4413](#) [4423](#) [4532](#) [4537](#) [TSD1404-12](#) [BK/FHN31G1](#) [BK/HC-5](#)