

IEC Appliance Inlet with protection degree IP67 / IP69K, Screw-on Mounting front side, Solder or Quick-connect Terminal



4761
Connector
black

with Cover (separate accessories)

Set consisting of appliance inlet and connector



See below:
[Approvals and Compliances](#)

Description

- Panel mount :
Screw-on mounting front side
- Appliance Inlet , Pin temperature 120 °C , Protection class I
- Solder / Quick Connect
- Complete set consisting of appliance inlet and outlet
- Mating connector type: 4762

Unique Selling Proposition

- Waterproofed Appliance Inlet IP67 / IP69K
- Suitable for equipments in harsh environment
- Specific shape to ensure IP protection
- Version in Black and White

Weblinks

[pdf data sheet](#), [html datasheet](#), [General Product Information](#), [Approvals](#), [Distributor-Stock-Check](#), [Accessories](#), [Detailed request for product](#), [Microsite](#), [Video](#)

Technical Data

| | |
|-----------------------------------|---|
| Ratings IEC | 10 A / 250VAC; 50Hz |
| Ratings UL/CSA | 15 A / 250VAC; 60Hz |
| Dielectric Strength | > 1.5kVAC between L-N > 1.5kVAC between L/N-PE (1 min/50Hz) |
| Allowable Operation Temperature | -25 °C to 120 °C |
| IP-Protection | front side IP67 acc. to IEC 60529 / IP69K acc. to ISO 20653 |
| Protection against electric shock | Suitable for appliances with protection class I acc. to IEC 61140 |
| Terminal | Solder / Quick Connect |
| Panel Thickness S | Screw: max 6mm Mounting screw torque max 3Nm |
| Material: Housing | Thermoplastic, black / white, UL 94V-0 |

| | |
|-------------------------|--|
| Appliance inlet/-outlet | S16 acc. to IEC 60320-1, UL 60320-1, CSA C22.2 no. 60320-1 (For hot conditions) pin-temperature 120 °C, 10A, Protection Class I Shape of connector S16 is SCHURTER specific |
|-------------------------|--|

Approvals and Compliances

Detailed information on product approvals, code requirements, usage instructions and detailed test conditions can be looked up in [Details about Approvals](#)

SCHURTER products are designed for use in industrial environments. They have approvals from independent testing bodies according to national and international standards. Products with specific characteristics and requirements such as required in the automotive sector according to IATF 16949, medical technology according to ISO 13485 or in the aerospace industry can be offered exclusively with customer-specific, individual agreements by SCHURTER.



Approvals

The approval mark is used by the testing authorities to certify compliance with the safety requirements placed on electronic products.
 Approval Reference Type: 4761

| Approval Logo | Certificates | Certification Body | Description |
|---------------|-------------------------------|--------------------|------------------------------|
| | VDE Approvals | VDE | Certificate Number: 40044311 |
| | UL Approvals | UL | UL File Number: E96454 |

Product standards

Product standards that are referenced

| Organization | Design | Standard | Description |
|--|-----------------------|-----------------------|---|
|  | Designed according to | IEC 60320-1 | Appliance couplers for household and similar general purposes |
|  | Designed according to | UL 60320-1 | Standard for Attachment Plugs and Receptacles |
|  | Designed according to | CSA C22.2 no. 60320-1 | General Use Receptacles, Attachment Plugs, and Similar Wiring Devices |







Application standards

Application standards where the product can be used

| Organization | Design | Standard | Description |
|--|--------------------------------|----------------|---|
|  | Designed for applications acc. | IEC/UL 62368-1 | Audio/video, information and communication technology equipment - Part 1: Safety requirements |

Compliances

The product complies with following Guide Lines

| Identification | Details | Initiator | Description |
|--|--|-------------|---|
|  | CE declaration of conformity | SCHURTER AG | The CE marking declares that the product complies with the applicable requirements laid down in the harmonisation of Community legislation on its affixing in accordance with EU Regulation 765/2008. |
|  | UKCA declaration of conformity | SCHURTER AG | The UKCA marking declares that the product complies with the applicable requirements laid down in the British Amendment of Regulation (EC) 765/2008. |
|  | RoHS | SCHURTER AG | Directive RoHS 2011/65/EU, Amendment (EU) 2015/863 |
|  | China RoHS | SCHURTER AG | The law SJ / T 11363-2006 (China RoHS) has been in force since 1 March 2007. It is similar to the EU directive RoHS. |
|  | Halogen Free | SCHURTER AG | SCHURTER strives to offer our customers halogen free products. |
|  | REACH | SCHURTER AG | On 1 June 2007, Regulation (EC) No 1907/2006 on the Registration, Evaluation, Authorization and Restriction of Chemicals 1 (abbreviated as "REACH") entered into force. |

Dimensions [mm]

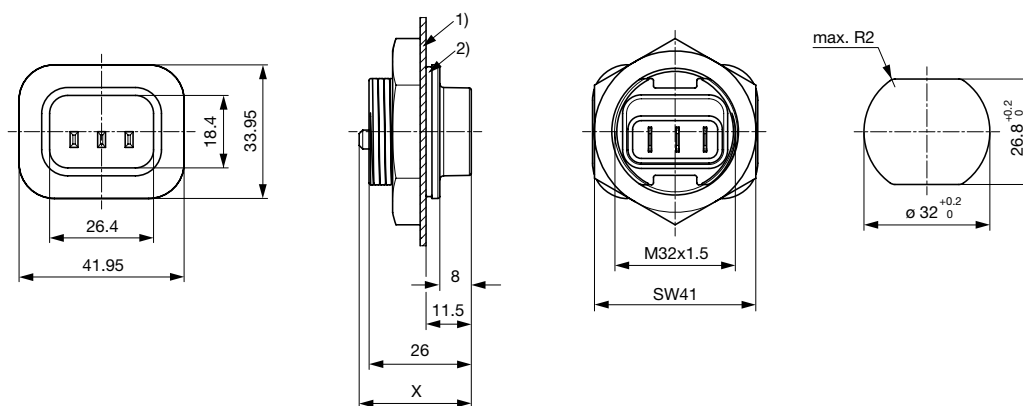

X: Quick-connect terminals 4.8x0.8 mm: 28.5 mm

X: Quick-connect terminals 6.3x0.8 mm: 31.0 mm

X: Solder terminals: 25.5 mm

1) Panel

2) Gasket or protection cover

All Variants

| Appliance Inlet | Connector | Kit | Color | Terminals Inlet | Order Number |
|-----------------|-----------|-----|-------|--------------------------------------|--------------|
| ● | | - | black | Quick connect terminals 4.8 x 0.8 mm | 4312.0000 |
| ● | | - | black | Quick connect terminals 6.3 x 0.8 mm | 4312.0001 |
| ● | | - | black | Solder terminals | 4312.0002 |
| ● | ● | 1) | black | Quick connect terminals 4.8 x 0.8 mm | 4312.0004 |
| ● | ● | 1) | black | Quick connect terminals 6.3 x 0.8 mm | 4312.0005 |
| ● | ● | 1) | black | Solder terminals | 4312.0006 |
| ● | | - | white | Quick connect terminals 4.8 x 0.8 mm | 4312.0007 |
| ● | | - | white | Quick connect terminals 6.3 x 0.8 mm | 4312.0008 |
| ● | | - | white | Solder terminals | 4312.0009 |
| ● | ● | 1) | white | Quick connect terminals 4.8 x 0.8 mm | 4312.0011 |
| ● | ● | 1) | white | Quick connect terminals 6.3 x 0.8 mm | 4312.0012 |
| ● | ● | 1) | white | Solder terminals | 4312.0013 |

1) complete set consisting of appliance inlet and outlet

Most Popular.

Availability for all products can be searched real-time: <https://www.schurter.com/en/Stock-Check/Stock-Check-SCHURTER>

Packaging unit 10 Pcs

Accessories

Description



Protection cover
 Protection cover for waterproof appliance coupler 4761 / 4762

Mating Outlets/Connectors shuttered

Category / Description



Connector Overview complete

4762 Mounting: Power Cord, 3 x 1 mm² / 3 x 18 AWG, Cable, Connector: S15

4762

X-ON Electronics

Largest Supplier of Electrical and Electronic Components

Click to view similar products for [AC Power Entry Modules](#) category:

Click to view products by [Schurter](#) manufacturer:

Other Similar products are found below :

[0098.0050](#) [6167.0002](#) [6609100-2](#) [7-6609955-2](#) [FKI2-50-6/M5](#) [FN361-6-06](#) [FN389-4-22](#) [FN9226B-6-02](#) [FN9233S1-10-06](#) [FN9233S1-8-06](#)
[FN9233S1B-8-06](#) [FN9233S1R-1-06](#) [FN9233S1R-12-06](#) [FN9233SB-1-06](#) [FN9233SB-12-06](#) [FN9233SB-8-06](#) [FN9233SR-10-06](#) [FN9244B-15-06HI](#) [FN9244EB-3-06](#) [FN9244EB-8-06](#) [FN9244ER-15-06](#) [FN9244ER-8-06](#) [FN9244ES1-8-06](#) [FN9244ESB-8-06](#) [FN9244R-12-06](#)
[FN9244S1-12-06](#) [FN9244S1R-3-06](#) [FN9244SB-8-06](#) [FN9244SR-6-06](#) [FN9244U-3-06](#) [FN9244U-8-06](#) [8-6609940-2](#) [PE00SSSXB](#) [Fuse-H-EUR-1](#) [Fuse-H-USA-1](#) [PM00XD000](#) [A-0701-HT-H](#) [15EJMS8](#) [1-6609941-2](#) [200JM6-2](#) [CA121003-6](#) [SK-1015\(F1-5\)](#) [161-R3015-E](#) [1-6609153-2](#) [FN323-1-05](#) [FN9233B-8-06](#) [FN9233EB-1-06](#) [FN9233ES1R-10-06](#) [FN9233R-12-06](#) [FN9233S-10-06](#)