

IEC Appliance Inlet C14 or C18 with Filter, high attenuation, ECO design, Front- or Rear Side Mounting



Screw-on mounting



Snap-in mounting
from front side



Snap-in 2 - 3 mm
with wires (stranded)



See below:
[Approvals and Compliances](#)

Description

- Panel mount :
Screw-on version from front or rear side, snap-in version from front side, PCB Version from rear side
- 2 Functions :
Appliance Inlet protection class I or II , Line filter in standard and medical version
- Solder/quick connect/wire (stranded)
- PCB
- Earth Terminal

Unique Selling Proposition

- Very high asymmetrical attenuation
- V-Lock cord retaining
- Metal flange for optimal shielding
- Compact design

Characteristics

- Compact filter with high asymmetrical attenuation
- Optimal shielding due to completely closed filter case, unpotted
- Suitable for assembly in metal plated plastic housings
- For applications according IEC/UL 62368-1 we recommend variants with bleed resistor
- Suitable for use in medical equipment according to IEC/UL 60601-1 (1 MOOP, 1 MOPP)

Other versions on request

- Snap-in for panel thickness >2mm to 3mm
- flexible wire with various lengths
- Class X1- and Y1-capacitors for enhanced withstand voltage
- Variant with plastic flange for front mounting

Weblinks

[pdf data sheet](#), [html datasheet](#), [General Product Information](#), [Approvals](#), [Distributor-Stock-Check](#), [Accessories](#), [Detailed request for product](#)

Technical Data

Ratings IEC	1 - 10A @ Ta 40 °C / 250VAC; 50Hz
Ratings UL/CSA	1 - 15A @ Ta 40 °C / 250VAC; 60Hz
Leakage Current	standard < 0.5 mA (250V / 60Hz) medical < 5 µA (250 V / 60 Hz)
Dielectric Strength	> 1.7 kVDC between L-N > 2.7 kVDC between L/N-PE Test voltage (2 sec)
Allowable Operation Temperature	-25 °C to 85 °C
Climatic Category	25/085/21 acc. to IEC 60068-1
IP-Protection	front side IP40 acc. to IEC 60529
Protection Class	Suitable for appliances with protection class I or II acc. to IEC 61140
Terminal	Quick connect terminals 6.3 x 0.8 mm Solder terminals Flexible wire AWG18 (15A AWG16), 150 mm
Panel Thickness S	Screw: max 8 mm Mounting screw torque max 0.5Nm Snap-in: 0.8 mm to 2 mm (all steps with one variant)
Material: Housing	Themoplast / steel tin-plated, black / metallic, UL 94V-0

Appliance inlet/-outlet	C14 / C18 acc. to IEC 60320-1, UL 498, CSA C22.2 no. 42 (for cold conditions) pin-temperature 70 °C, 10A, Protection Class I or II
Line Filter	Standard and Medical Version, IEC 60939, UL 1283, CSA C22.2 no. 8 Technical Details
MTBF	> 3'000'000h acc. to MIL-HB-217 F

Approvals and Compliances



Detailed information on product approvals, code requirements, usage instructions and detailed test conditions can be looked up in [Details about Approvals](#)

SCHURTER products are designed for use in industrial environments. They have approvals from independent testing bodies according to national and international standards. Products with specific characteristics and requirements such as required in the automotive sector according to IATF 16949, medical technology according to ISO 13485 or in the aerospace industry can be offered exclusively with customer-specific, individual agreements by SCHURTER.

Approvals







The approval mark is used by the testing authorities to certify compliance with the safety requirements placed on electronic products.

Approval Reference Type: 5123

Approval Logo	Certificates	Certification Body	Description
	VDE Approvals	VDE	Certificate Number: 40016382
	UL Approvals	UL	UL File Number: E72928



Product standards

Product standards that are referenced

Organization	Design	Standard	Description
	Designed according to	IEC 60320-1	Appliance couplers for household and similar general purposes
	Designed according to	IEC 60939	Passive filters for suppressing electromagnetic interference
	Designed according to	IEC 61058-1	Switches for appliances. Part 1. General requirements
	Designed according to	UL 498	Standard for Attachment Plugs and Receptacles
	Designed according to	UL 1283	Electromagnetic interference filters
	Designed according to	CSA C22.2 no. 42	General Use Receptacles, Attachment Plugs, and Similar Wiring Devices
	Designed according to	CSA C22.2 no. 8	Electromagnetic interference (EMI) filters







Application standards

Application standards where the product can be used

Organization	Design	Standard	Description
	Designed for applications acc.	IEC/UL 62368-1	Audio/video, information and communication technology equipment - Part 1: Safety requirements
	Designed for applications acc.	IEC 60601-1	Medical electrical equipment - Part 1: General requirements for basic safety and essential performance

Compliances

The product complies with following Guide Lines

Identification	Details	Initiator	Description
	CE declaration of conformity	SCHURTER AG	The CE marking declares that the product complies with the applicable requirements laid down in the harmonisation of Community legislation on its affixing in accordance with EU Regulation 765/2008.
	UKCA declaration of conformity	SCHURTER AG	The UKCA marking declares that the product complies with the applicable requirements laid down in the British Amendment of Regulation (EC) 765/2008.
	RoHS	SCHURTER AG	Directive RoHS 2011/65/EU, Amendment (EU) 2015/863
	China RoHS	SCHURTER AG	The law SJ / T 11363-2006 (China RoHS) has been in force since 1 March 2007. It is similar to the EU directive RoHS.
	REACH	SCHURTER AG	On 1 June 2007, Regulation (EC) No 1907/2006 on the Registration, Evaluation, Authorization and Restriction of Chemicals 1 (abbreviated as "REACH") entered into force.
		SCHURTER AG	V-Lock system are based on a matching plug-dose combination. The connector is equipped with a notch intended for use with the latching cordset. The cord latching system prevents against accidental removal of the cordset.
	Medical Equipment	SCHURTER AG	Suitable for use in medical equipment according to IEC/UL 60601-1 (1 MOOP, 1 MOPP)

Dimension [mm]

Front or rear side mounting for screws with nuts or blind rivets (panel cutout for frontside mounting)

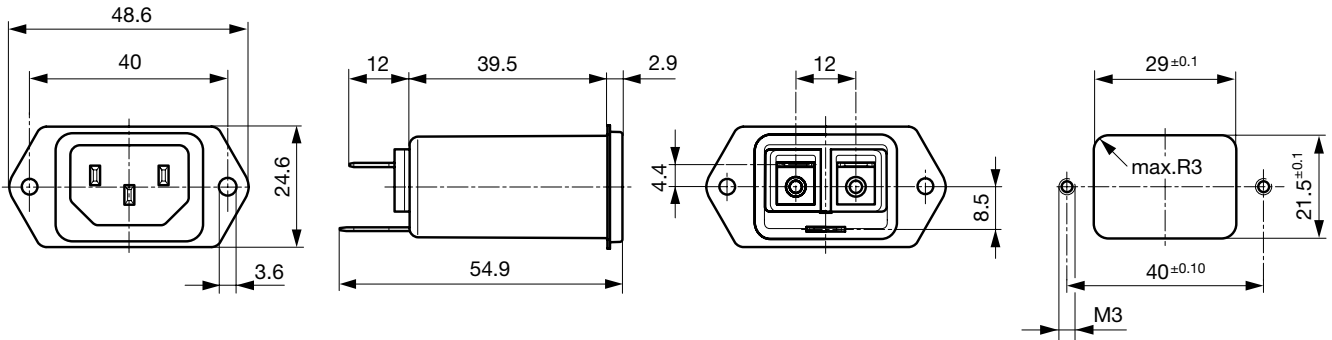

Rear side mounting with pre-formed, threaded holes for M3 screws (panel cutout for rear side mounting)

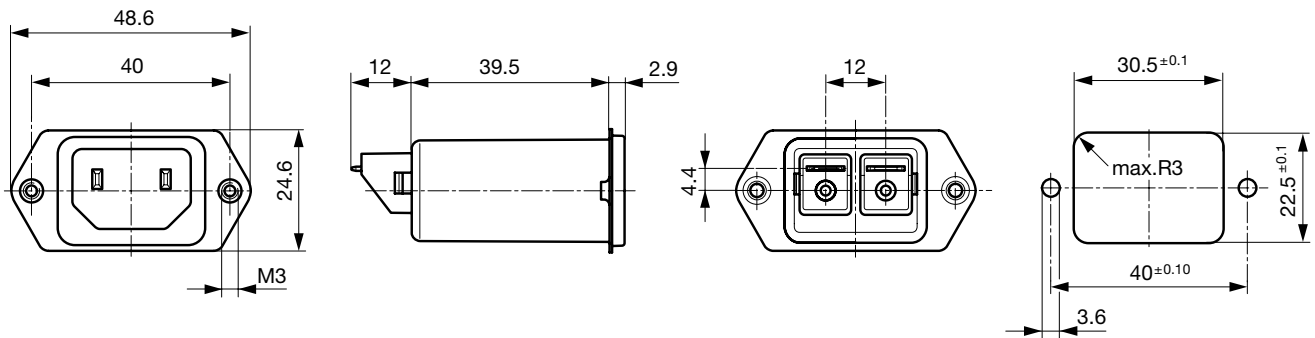

Dimensions for class II version also apply to class I

Snap-in mounting from front side

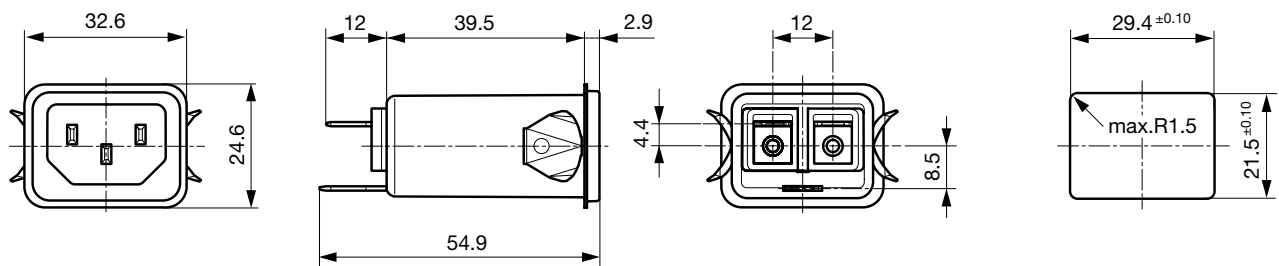

Dimensions for class I version also apply class II

PCB snap-in rear side mounting, protection class II

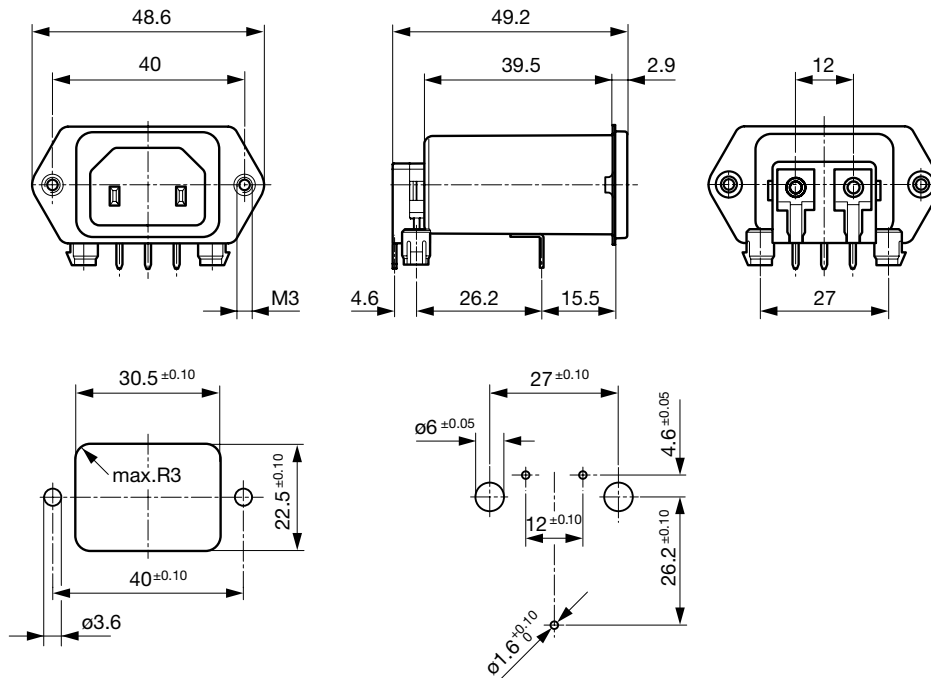

PCB rear side mounting, protection class II

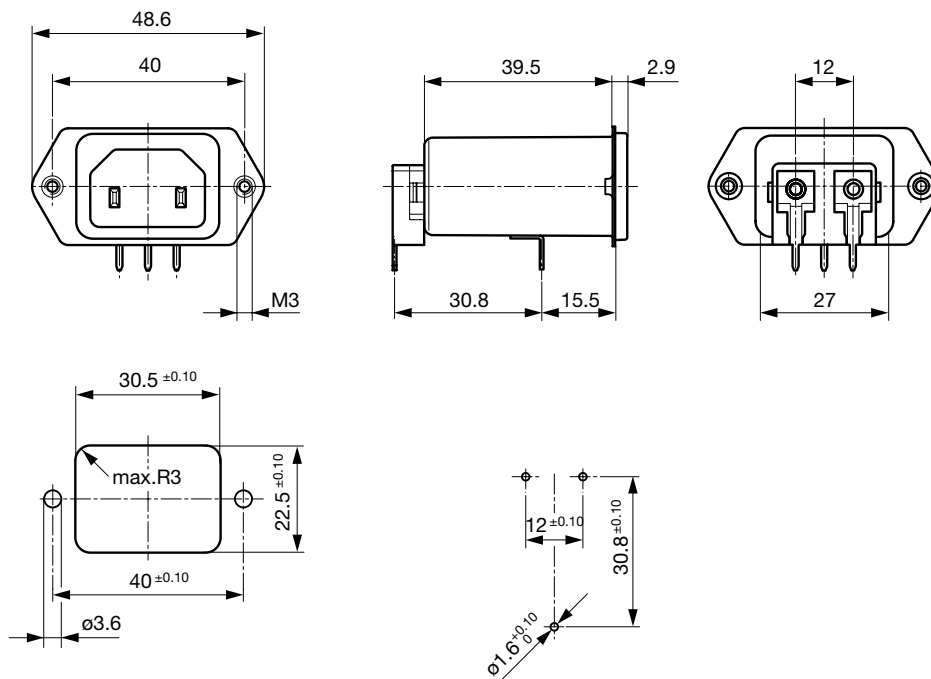

Screw and snap-in mounting with flexible wire

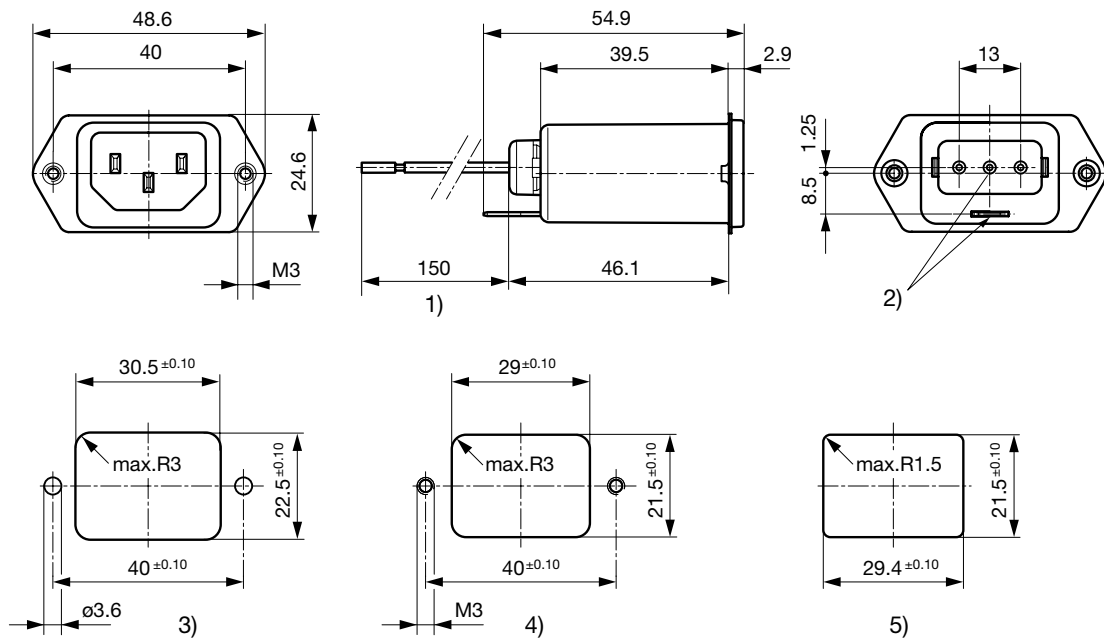

- 1) Flexible wire, standard length 150 mm or special length on request
- 2) Nonexistent for protection class II
- 3) Panel cut-out screw-on version, back-side mounting
- 4) Panel cut-out screw-on version, front- or back-side mounting
- 5) Panel cut-out snap-in version, front-side mounting

Technical Data of Filter-Components

Rated Current [A]	Filter-Type	Inductances L [mH]	Capacitance CX [nF]	Capacitance CY [nF]	R [MΩ]
1	Standard version	2 x 20	100	2.2	-
2	Standard version	2 x 9	100	2.2	-
4	Standard version	2 x 3.4	100	2.2	-
6	Standard version	2 x 1.6	100	2.2	-
10	Standard version	2 x 0.65	100	2.2	-
15	Standard version	2 x 0.2	100	2.2	-
1	Medical Version (M5)	2 x 20	100	-	1
2	Medical Version (M5)	2 x 9	100	-	1
4	Medical Version (M5)	2 x 3.4	100	-	1
6	Medical Version (M5)	2 x 1.6	100	-	1
10	Medical Version (M5)	2 x 0.65	100	-	1
15	Medical Version (M5)	2 x 0.2	100	-	1
4	Medical Version (M80)	2 x 3.4	100	0.47	1
6	Medical Version (M80)	2 x 1.6	100	0.47	1

Diagrams

Standard version

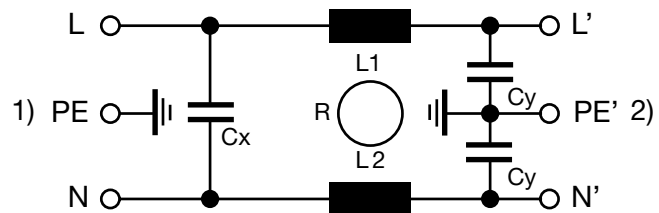

1) Line
 2) Load

Standard version / Medical version M80

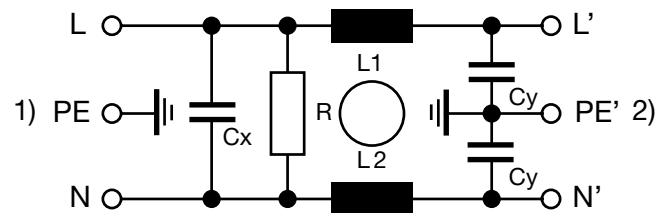

1) Line
 2) Load

Medical Version (M5)

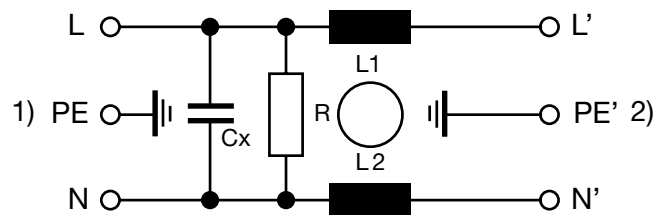

1) Line
 2) Load

Medicalversion (M5), Protection Class II

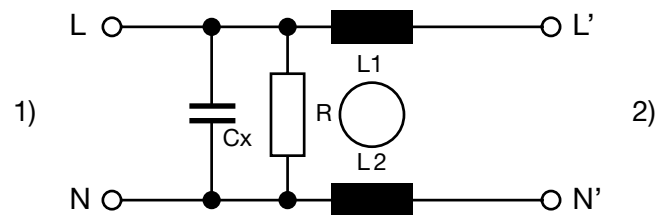

1) Line
 2) Load

Attenuation Loss

--- 50Ω differential mode ____ 50Ω common mode

Standard version

1 A

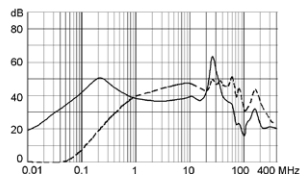

2 A

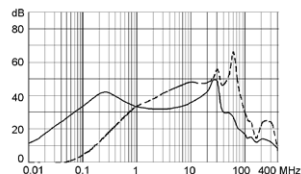

4 A

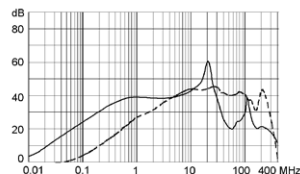

6 A

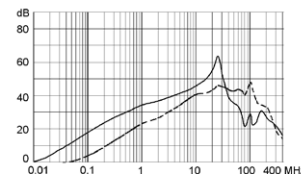

10 A

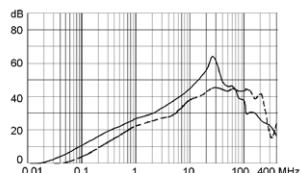

15 A

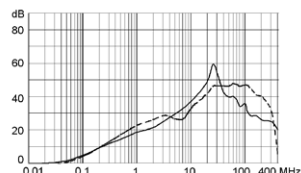

Medical version (M5)

1 A

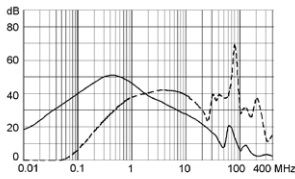

2 A

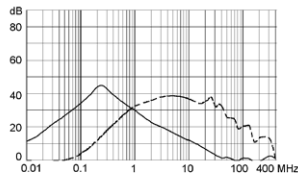

4 A

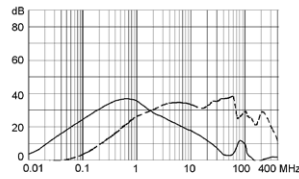

6 A

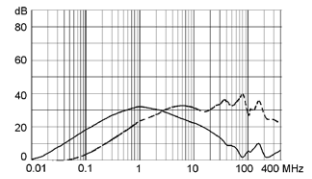

10 A

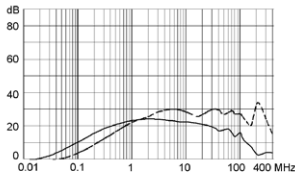

15 A

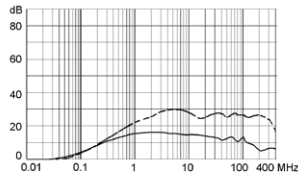

Medical version (M80)

1 A

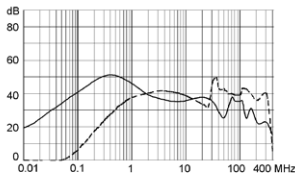

2 A

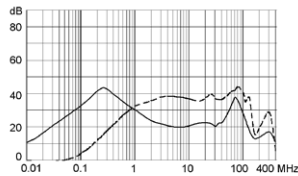

4 A

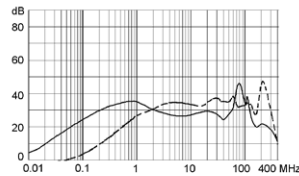

6 A

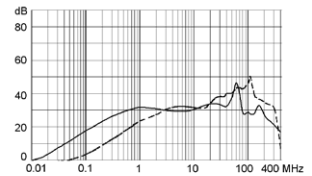

10 A

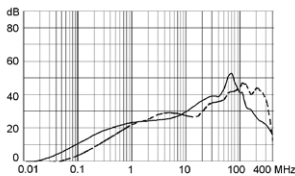

15 A

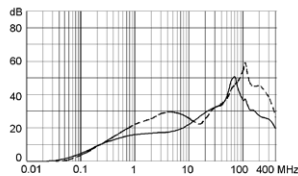

All Variants

Rated Current [A]	Filter-Type	Mounting	Mounting side	Terminal	Protection Class	V-Lock	Order Number
1	Standard version	Snap-in	Front Side	Quick connect terminals 6.3 x 0.8 mm	I	●	5123.2000.0
2	Standard version	Snap-in	Front Side	Quick connect terminals 6.3 x 0.8 mm	I	●	5123.2001.0
4	Standard version	Snap-in	Front Side	Quick connect terminals 6.3 x 0.8 mm	I	●	5123.2003.0
6	Standard version	Snap-in	Front Side	Quick connect terminals 6.3 x 0.8 mm	I	●	5123.2004.0
10	Standard version	Snap-in	Front Side	Quick connect terminals 6.3 x 0.8 mm	I	●	5123.2006.0
15	Standard version	Snap-in	Front Side	Quick connect terminals 6.3 x 0.8 mm	I	●	5123.2007.0
6	Standard version	Screw/PCB	Rear Side	PCB pin and earth pin 6.3 x 0.8	I	●	5123.4074.0

Rated Current [A]	Filter-Type	Mounting	Mounting side	Terminal	Protection Class	V-Lock	Order Number
1	Standard version	Screw	Rear Side	Quick connect terminals 6.3 x 0.8 mm	I	●	5123.1000.0
2	Standard version	Screw	Rear Side	Quick connect terminals 6.3 x 0.8 mm	I	●	5123.1001.0
4	Standard version	Screw	Rear Side	Quick connect terminals 6.3 x 0.8 mm	I	●	5123.1003.0
6	Standard version	Screw	Rear Side	Quick connect terminals 6.3 x 0.8 mm	I	●	5123.1004.0
10	Standard version	Screw	Rear Side	Quick connect terminals 6.3 x 0.8 mm	I	●	5123.1006.0
10	Standard version	Screw	Rear Side	Flexible wire and Earth pin 6.3 x 0.8	I	●	5123.1046.0
15	Standard version	Screw	Rear Side	Quick connect terminals 6.3 x 0.8 mm	I	●	5123.1007.0
1	Standard version	Screw	Front-/Rear-Side	Quick connect terminals 6.3 x 0.8 mm	I	●	5123.0000.0
2	Standard version	Screw	Front-/Rear-Side	Quick connect terminals 6.3 x 0.8 mm	I	●	5123.0001.0
4	Standard version	Screw	Front-/Rear-Side	Quick connect terminals 6.3 x 0.8 mm	I	●	5123.0003.0
4	Standard version	Screw	Front-/Rear-Side	Flexible wire AWG18	I	●	5123.0233.0
6	Standard version	Screw	Front-/Rear-Side	Quick connect terminals 6.3 x 0.8 mm	I	●	5123.0004.0
10	Standard version	Screw	Front-/Rear-Side	Quick connect terminals 6.3 x 0.8 mm	I	●	5123.0006.0
15	Standard version	Screw	Front-/Rear-Side	Quick connect terminals 6.3 x 0.8 mm	I	●	5123.0007.0
1	Medical Version (M5)	Snap-in	Front Side	Quick connect terminals 6.3 x 0.8 mm	I	●	5123.2300.0
2	Medical Version (M5)	Snap-in	Front Side	Quick connect terminals 6.3 x 0.8 mm	I	●	5123.2301.0
4	Medical Version (M5)	Snap-in	Front Side	Quick connect terminals 6.3 x 0.8 mm	I	●	5123.2303.0
6	Medical Version (M5)	Snap-in	Front Side	Quick connect terminals 6.3 x 0.8 mm	I	●	5123.2304.0
10	Medical Version (M5)	Snap-in	Front Side	Quick connect terminals 6.3 x 0.8 mm	I	●	5123.2306.0
15	Medical Version (M5)	Snap-in	Front Side	Quick connect terminals 6.3 x 0.8 mm	I	●	5123.2307.0
1	Medical Version (M5)	Screw	Rear Side	Quick connect terminals 6.3 x 0.8 mm	I	●	5123.1300.0
2	Medical Version (M5)	Screw	Rear Side	Quick connect terminals 6.3 x 0.8 mm	I	●	5123.1301.0
4	Medical Version (M5)	Screw	Rear Side	Quick connect terminals 6.3 x 0.8 mm	I	●	5123.1303.0
6	Medical Version (M5)	Screw	Rear Side	Quick connect terminals 6.3 x 0.8 mm	I	●	5123.1304.0
10	Medical Version (M5)	Screw	Rear Side	Quick connect terminals 6.3 x 0.8 mm	I	●	5123.1306.0
15	Medical Version (M5)	Screw	Rear Side	Quick connect terminals 6.3 x 0.8 mm	I	●	5123.1307.0
1	Medical Version (M5)	Screw	Front-/Rear-Side	Quick connect terminals 6.3 x 0.8 mm	I	●	5123.0300.0

Rated Current [A]	Filter-Type	Mounting	Mounting side	Terminal	Protection Class	V-Lock	Order Number
2	Medical Version (M5)	Screw	Front-/Rear-Side	Quick connect terminals 6.3 x 0.8 mm	I	●	5123.0301.0
4	Medical Version (M5)	Screw	Front-/Rear-Side	Quick connect terminals 6.3 x 0.8 mm	I	●	5123.0303.0
6	Medical Version (M5)	Screw	Front-/Rear-Side	Quick connect terminals 6.3 x 0.8 mm	I	●	5123.0304.0
10	Medical Version (M5)	Screw	Front-/Rear-Side	Quick connect terminals 6.3 x 0.8 mm	I	●	5123.0306.0
15	Medical Version (M5)	Screw	Front-/Rear-Side	Quick connect terminals 6.3 x 0.8 mm	I	●	5123.0307.0
2	Medical Version (M5)	Screw	Front-/Rear-Side	Quick connect terminals 6.3 x 0.8 mm	II	●	3-128-163
4	Medical Version (M80)	Screw	Rear Side	Flexible wire and Earth pin 6.3 x 0.8	I	●	3-119-787
4	Medical Version (M80)	Screw	Front-/Rear-Side	Flexible wire and Earth pin 6.3 x 0.8	I	●	3-119-595
6	Medical Version (M80)	Screw	Front-/Rear-Side	Quick connect terminals 6.3 x 0.8 mm	I	●	5123.0504.0

Availability for all products can be searched real-time: <https://www.schurter.com/en/Stock-Check/Stock-Check-SCHURTER>

- 15 A version only according UL/CSA

- Type for screw-on mounting from rear side has pre-threaded holes for M3 screws

Packaging unit

10 Pcs

Accessories

Description



Wire Harness
 Wire harness for SCHURTER products



Assorted Covers
 Rear Cover



RC320
 Rear Cover for Power Entry Module

Description



[Cord retaining kits](#)
 Cord retaining strain relief

Mating Outlets/Connectors

Category / Description

[Appliance Outlet Overview complete](#)



4787, Mounting: Screw-on mounting, Appliance Outlet: IEC Solder terminals, 10 A, Suitable for appliances with protection class I	4787
4788, Mounting: Snap-in version, Appliance Outlet: IEC Solder / Quick Connect, 10 A, Suitable for appliances with protection class I	4788
IEC Appliance Outlet F or H, Screw-on Mounting, Front Side, Solder, PCB or Quick-connect Terminal	5091

[Connector Overview complete](#)



4782 Mounting: Power Cord, 3 x 1 mm ² / 3 x 18 AWG, Cable, Connector: IEC C13	4782
4785 Mounting: Power Cord, 3 x 1 mm ² / 3 x 18 AWG, Cable, Connector: IEC C13	4785
4300-06 Mounting: Power Cord, 3 x 1 mm ² / 3 x 18 AWG, Cable, Connector: IEC C13	4300-06

Mating Outlets/Connectors shuttered

[Connector Overview complete](#)



4783 Mounting: Power Cord, 3 x 1 mm ² / 3 x 18 AWG, Cable, Connector: IEC C13	4783
--	------

[Power Cord Overview complete](#)



VAC13KS, Overview, V-Lock cord retaining, diverse Connector IEC C13, diverse, black	VAC13KS
VAC17KS, V-Lock cord retaining, diverse m, Connector IEC C17, diverse, black / grey / white	VAC17KS

X-ON Electronics

Largest Supplier of Electrical and Electronic Components

Click to view similar products for [AC Power Entry Modules](#) category:

Click to view products by [Schurter](#) manufacturer:

Other Similar products are found below :

[0098.0050](#) [6167.0002](#) [6609100-2](#) [7-6609955-2](#) [FKI2-50-6/M5](#) [FN361-6-06](#) [FN389-4-22](#) [FN9226B-6-02](#) [FN9233S1-10-06](#) [FN9233S1-8-06](#)
[FN9233S1B-8-06](#) [FN9233S1R-1-06](#) [FN9233S1R-12-06](#) [FN9233SB-1-06](#) [FN9233SB-12-06](#) [FN9233SB-8-06](#) [FN9233SR-10-06](#) [FN9244B-15-06HI](#) [FN9244EB-3-06](#) [FN9244EB-8-06](#) [FN9244ER-15-06](#) [FN9244ER-8-06](#) [FN9244ES1-8-06](#) [FN9244ESB-8-06](#) [FN9244R-12-06](#)
[FN9244S1-12-06](#) [FN9244S1R-3-06](#) [FN9244SB-8-06](#) [FN9244SR-6-06](#) [FN9244U-3-06](#) [FN9244U-8-06](#) [8-6609940-2](#) [PE00SSSXB](#) [Fuse-H-EUR-1](#) [Fuse-H-USA-1](#) [PM00XD000](#) [A-0701-HT-H](#) [15EJMS8](#) [1-6609941-2](#) [200JM6-2](#) [CA121003-6](#) [SK-1015\(F1-5\)](#) [161-R3015-E](#) [1-6609153-2](#) [FN323-1-05](#) [FN9233B-8-06](#) [FN9233EB-1-06](#) [FN9233ES1R-10-06](#) [FN9233R-12-06](#) [FN9233S-10-06](#)