

2-stage filter for 3-phase systems

new



See below:

Approvals and Compliances

Description

- Terminals for three phases, neutral conductor and ground
- 2 stage
- Very high attenuation
- Industrial or low leakage current versions

Unique Selling Proposition

- Compact design with small footprint
- Double-stage filter for high attenuation
- Light weight design
- Wide temperature range

Applications

- Voltage rating 520 or 760 VAC for various applications
- Protection against interference voltage from the mains
- Especially designed for industrial applications such as: Frequency Converters, Stepper Motor Drives, UPS-Systems, Inverters
- Suitable for use in equipment according to IEC/UL 62368-1

Weblinks

[pdf data sheet](#), [html datasheet](#), [General Product Information](#), [Approvals](#), [Distributor-Stock-Check](#), [Detailed request for product](#), [Microsite](#)

Technical Data

Rated Current	16 - 230A
Rated voltage	520/760VAC, 50/60 Hz
Approval for	16 - 230A @ 50 °C / 520/760VAC; 50/60Hz
Overload Current	1.5 x Ir for 1 minute, per hour
Dielectric Strength	> 520V / 2.25 kVDC between L-L > 520V / 2.75 kVDC between L-PE > 760V / 3.27 kVDC between L-L > 760V / 3.20 kVDC between L-PE Test voltage 2 sec
Number of Filter Stages	2-stage
Weight	1 - 5.9kg
Material: Housing	Metal
Sealing Compound	UL 94V-0

Mounting	Screw-on mounting on chassis
Terminal	Screw clamps
Operating Temperature	-40°C to 100°C
Climatic Category	40/100/21 acc. to IEC 60068-1
Degree of Protection	IP20 acc. to IEC 60529
Protection Class	Suitable for appliances with protection class I acc. to IEC 61140
MTBF	> 200'000h acc. to MIL-HB-217 F

Approvals and Compliances

Detailed information on product approvals, code requirements, usage instructions and detailed test conditions can be looked up in [Details about Approvals](#)

SCHURTER products are designed for use in industrial environments. They have approvals from independent testing bodies according to national and international standards. Products with specific characteristics and requirements such as required in the automotive sector according to IATF 16949, medical technology according to ISO 13485 or in the aerospace industry can be offered exclusively with customer-specific, individual agreements by SCHURTER.

Approvals



The approval mark is used by the testing authorities to certify compliance with the safety requirements placed on electronic products.

Approval Reference Type: FMBD NEO

Approval Logo	Certificates	Certification Body	Description
	VDE Approvals	VDE	Certificate Number: 40053230
	UL Approvals	UL	UL File Number: E495089

Product standards

Product standards that are referenced

Organization	Design	Standard	Description
	Designed according to	IEC 60939	Passive filters for suppressing electromagnetic interference
	Designed according to	UL 1283	Electromagnetic interference filters





Application standards

Application standards where the product can be used

Organization	Design	Standard	Description
	Designed for applications acc.	IEC/UL 62368-1	Audio/video, information and communication technology equipment - Part 1: Safety requirements

Compliances

The product complies with following Guide Lines

Identification	Details	Initiator	Description
	CE declaration of conformity	SCHURTER AG	The CE marking declares that the product complies with the applicable requirements laid down in the harmonisation of Community legislation on its affixing in accordance with EU Regulation 765/2008.
	RoHS	SCHURTER AG	Directive RoHS 2011/65/EU, Amendment (EU) 2015/863
	China RoHS	SCHURTER AG	The law SJ / T 11363-2006 (China RoHS) has been in force since 1 March 2007. It is similar to the EU directive RoHS.
	REACH	SCHURTER AG	On 1 June 2007, Regulation (EC) No 1907/2006 on the Registration, Evaluation, Authorization and Restriction of Chemicals 1 (abbreviated as "REACH") entered into force.

Dimension [mm]

Case 5A-4

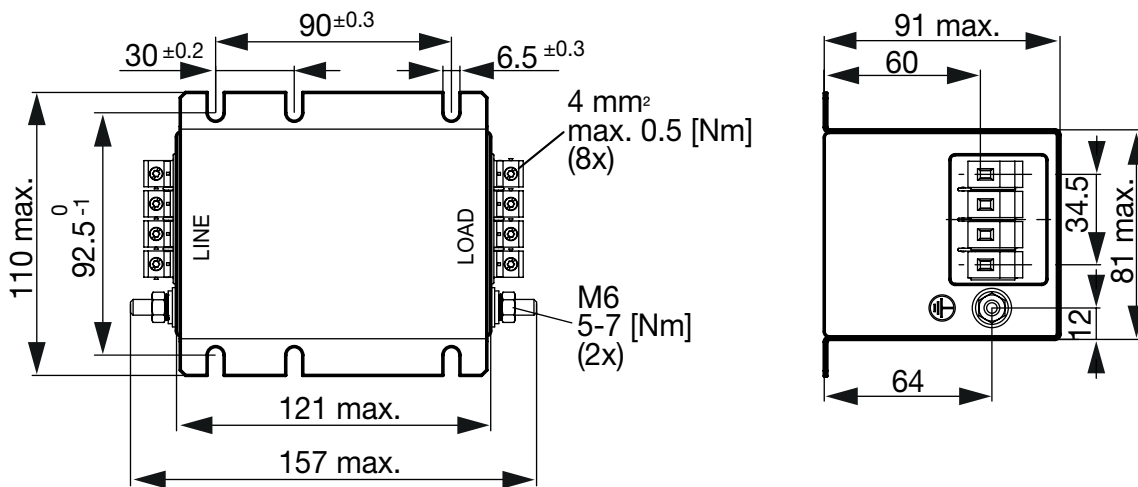

Case 5A-10

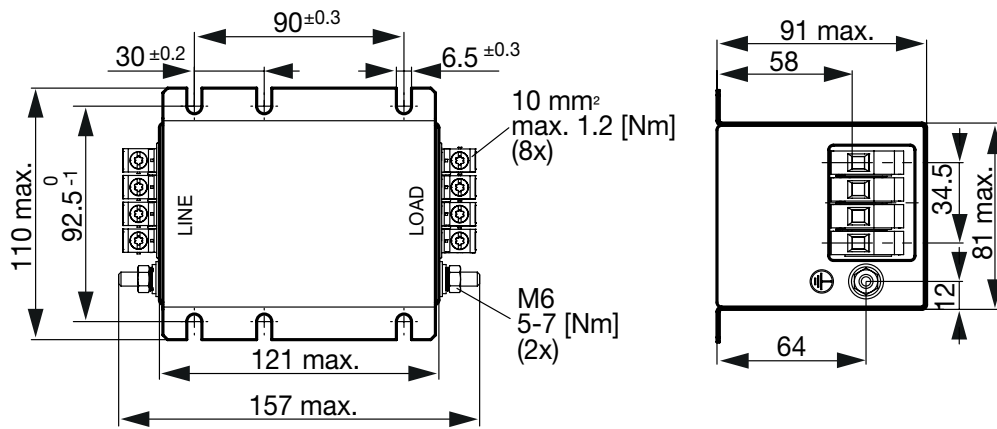

Case 5B-10

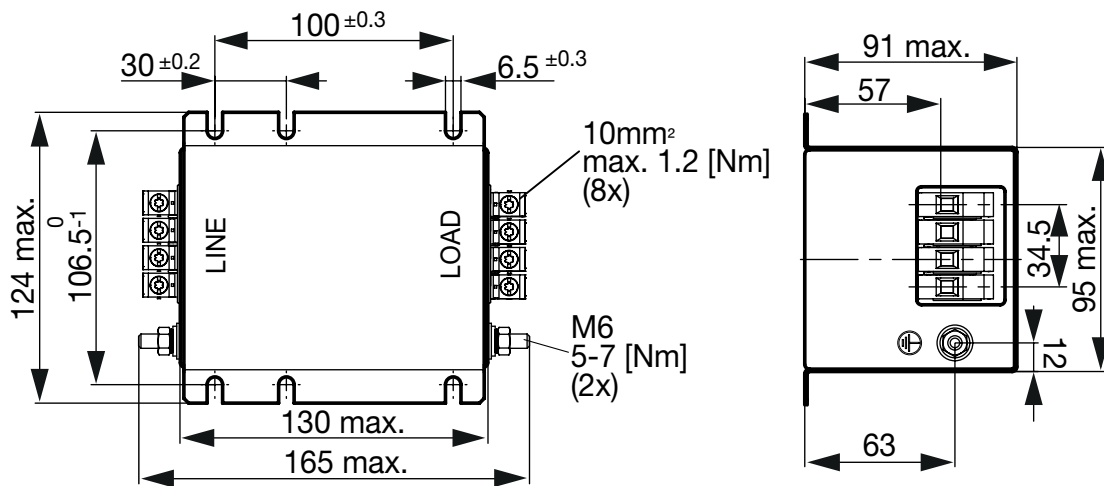

Case 5B-16

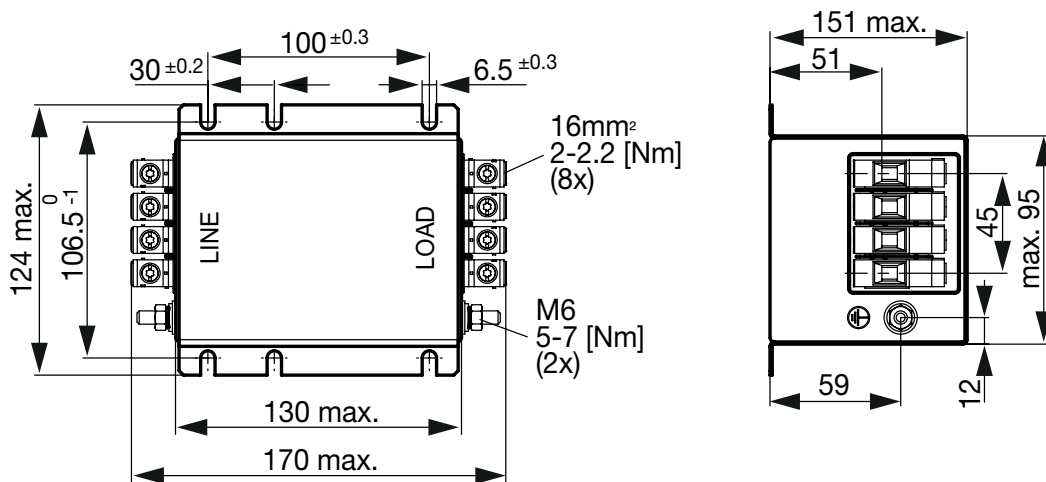

Case 5C-25

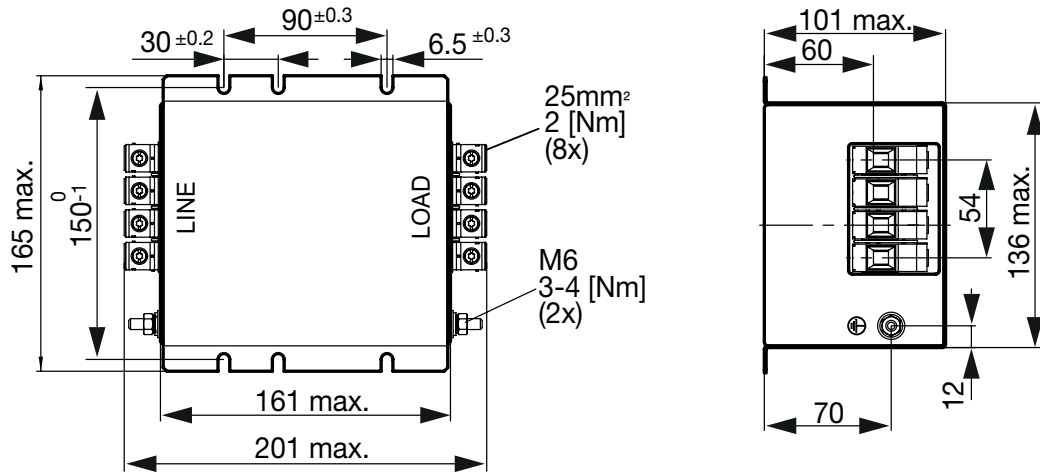

Case 5C-50

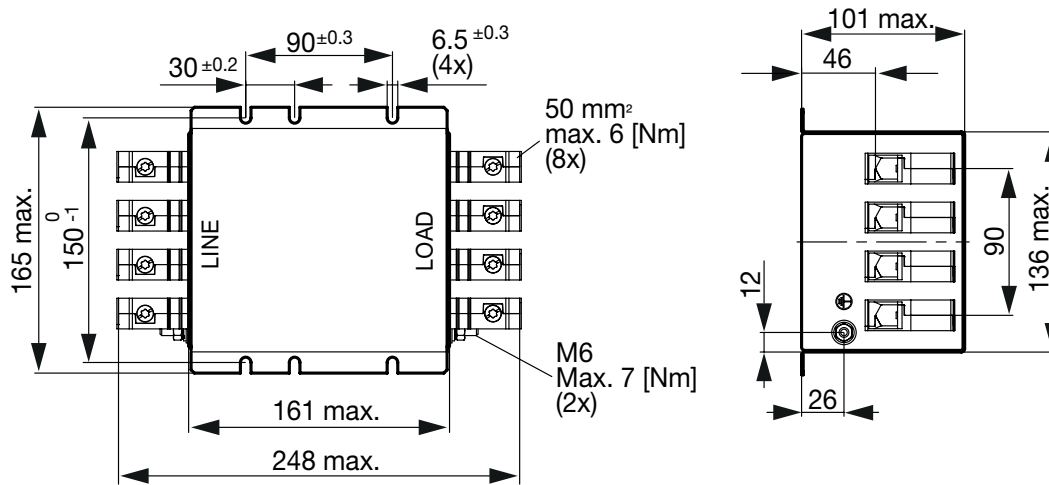

Case 5D-95

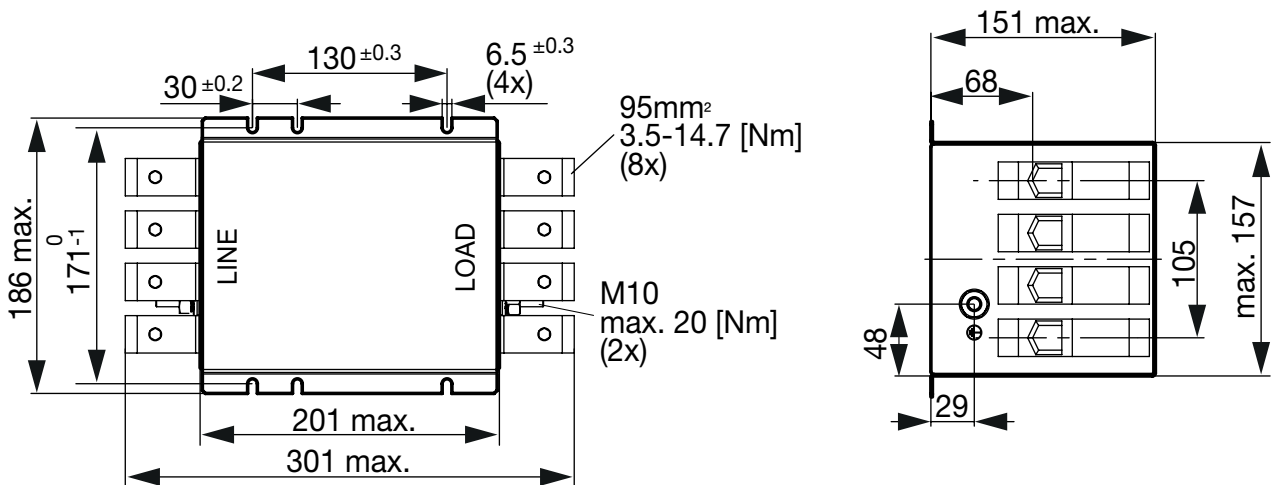

Diagrams

Low leakage current version

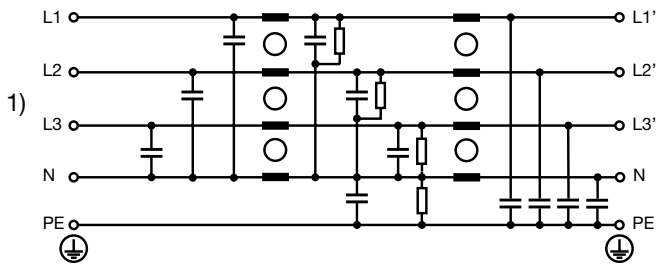

1) Line

Attenuation Loss 0.1/100Ω differential mode 100/0.1Ω differential mode - - - - 50Ω differential mode ____ 50Ω common mode
 Industrial version

16 A / 520 V

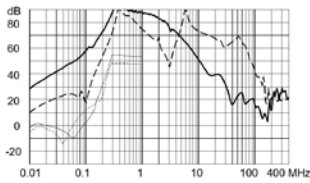

25 A / 520 V

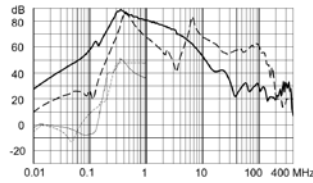

36 A / 520 V

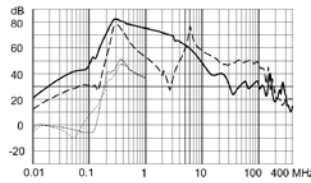

50 A / 520 V

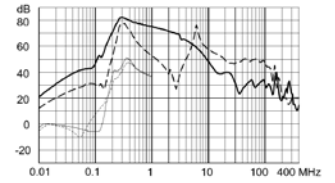

64 A / 520 V

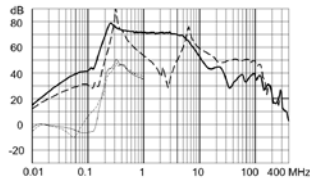

80 A / 520 V

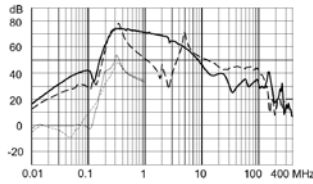

110 A / 520 V

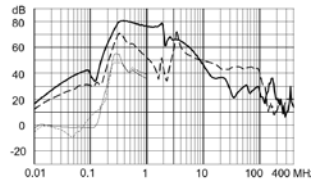

180 A / 520 V

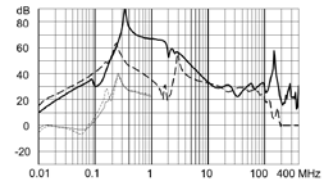

230 A / 520 V

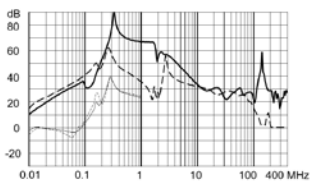

16 A / 760 V

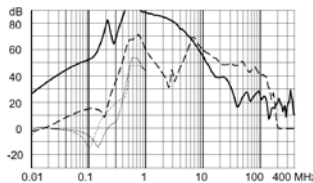

25 A / 760 V

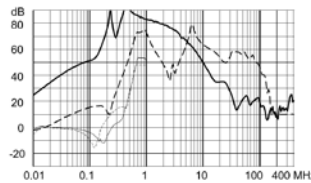

36 A / 760 V

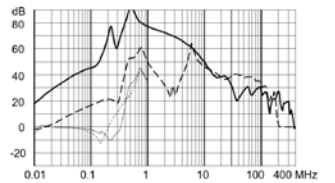

50 A / 760 V

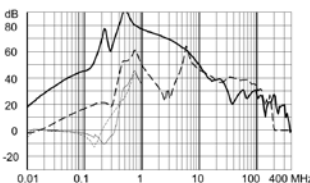

64 A / 760 V

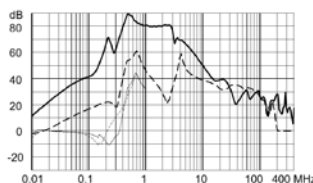

80 A / 760 V

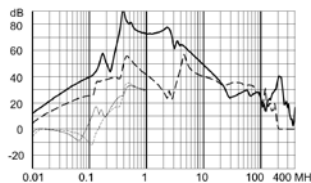

110 A / 760 V

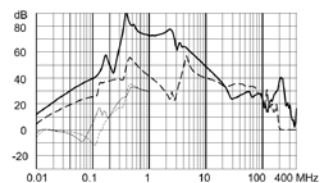

180 A / 760 V

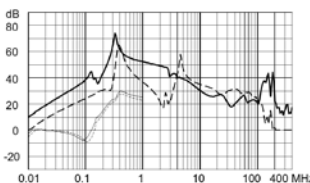

230 A / 760 V

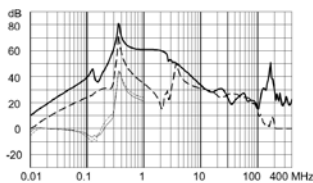

Low leakage current version

16 A / 520 V

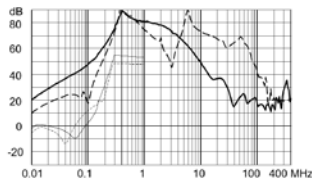

25 A / 520 V

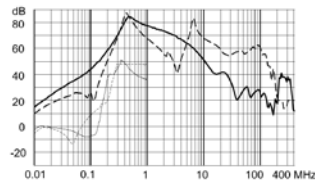

36 A / 520 V

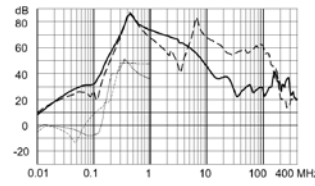

50 A / 520 V

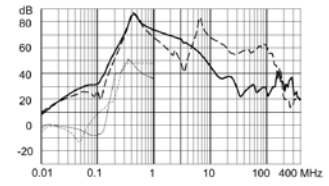

64 A / 520 V

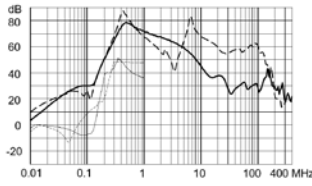

16 A / 760 V

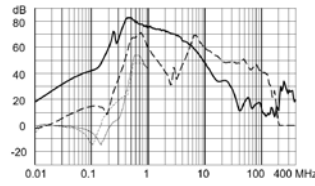

25 A / 760 V

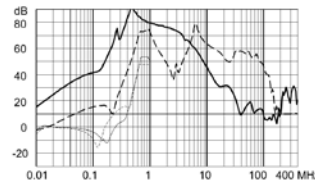

36 A / 760 V

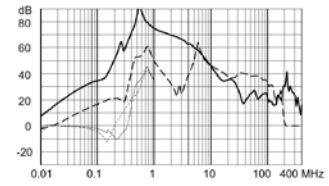

50 A / 760 V

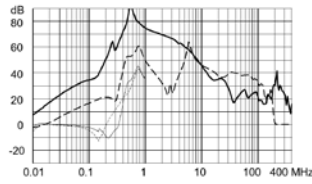

64 A / 760 V

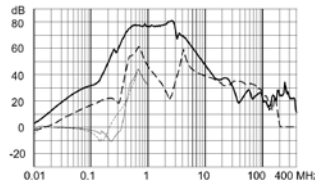

All Variants

Rated Current @ Ta 50°C [A]	Rated Voltage [VAC]	Filter Type	Tripped Power Dissipation [W]	Contact Resi- stance [mΩ]	Leakage Cur- rent [mA] @ 440V, 60Hz 1)	Weight [kg]	Screw clamps [mm ² 2)	Housing	Order Number
16	520	Industrial version	1.3	4.9	6.82	1 kg	4	5A-4	3-128-371
25	520	Industrial version	1.6	2.5	9.42	1.1 kg	10	5A-10	3-128-412
36	520	Industrial version	2.1	1.6	9.42	1.35 kg	10	5B-10	3-128-413
50	520	Industrial version	4	1.6	9.42	1.35 kg	10	5B-10	3-128-414
64	520	Industrial version	5	1.2	9.42	1.6 kg	16	5B-16	3-128-415
80	520	Industrial version	7.7	1.2	9.42	2.5 kg	25	5C-25	3-128-416
110	520	Industrial version	15.8	1.3	9.42	3.3 kg	50	5C-50	3-128-417
180	520	Industrial version	13	0.4	8.97	4.8 kg	95	5D	3-128-418
230	520	Industrial version	10.6	0.2	8.97	5.9 kg	95	5D	3-128-419
16	520	Low leakage current version	1.3	4.9	2.55	1 kg	4	5A-4	3-128-420
25	520	Low leakage current version	1.6	2.5	2.55	1.1 kg	10	5A-10	3-128-421
36	520	Low leakage current version	2.1	1.6	2.56	1.35 kg	10	5B-10	3-128-422
50	520	Low leakage current version	4	1.6	2.56	1.35 kg	10	5B-10	3-128-423
64	520	Low leakage current version	5	1.2	2.56	1.6 kg	16	5B-16	3-128-424
16	760	Industrial version	1.3	4.9	6.37	1 kg	4	5A-4	3-128-425
25	760	Industrial version	1.6	2.5	6.37	1.1 kg	10	5A-10	3-128-426
36	760	Industrial version	2.1	1.6	6.37	1.35 kg	10	5B-10	3-128-427
50	760	Industrial version	4	1.6	6.37	1.35 kg	10	5B-10	3-128-428
64	760	Industrial version	5	1.2	6.37	1.6 kg	16	5B-16	3-128-429
80	760	Industrial version	7.7	1.2	8.97	2.5 kg	25	5C-25	3-128-430

Rated Current @ Ta 50°C [A]	Rated Voltage [VAC]	Filter Type	Tripped Power Dissipation [W]	Contact Resi- stance [mΩ]	Leakage Cur- rent [mA] @ 440V, 60Hz 1)	Weight [kg]	Screw clamps [mm ²] 2)	Housing	Order Number
110	760	Industrial version	15.8	1.3	8.97	3.3 kg	50	5C-50	3-128-431
180	760	Industrial version	13	0.4	8.97	4.8 kg	95	5D	3-128-432
230	760	Industrial version	10.6	0.2	8.97	5.9 kg	95	5D	3-128-433
16	760	Low leakage current version	1.3	4.9	2.11	1 kg	4	5A-4	3-128-434
25	760	Low leakage current version	1.6	2.5	2.11	1.1 kg	10	5A-10	3-128-435
36	760	Low leakage current version	2.1	1.6	2.11	1.35 kg	10	5B-10	3-128-436
50	760	Low leakage current version	4	1.6	2.11	1.35 kg	10	5B-10	3-128-437
64	760	Low leakage current version	5	1.2	2.11	1.6 kg	16	5B-16	3-128-438

Availability for all products can be searched real-time: <https://www.schurter.com/en/Stock-Check/Stock-Check-SCHURTER>

1) Leakage current according IEC 60939-1

2) Maximum conductor cross section (wire gauge) to be used; a comparative table for AWG and mm² values can be found in the general product information <https://www.schurter.com/en/FAQ#10>

Packaging unit 1 Pcs

X-ON Electronics

Largest Supplier of Electrical and Electronic Components

Click to view similar products for [Power Line Filters](#) category:

Click to view products by [Schurter](#) manufacturer:

Other Similar products are found below :

[6609019-3](#) [6609026-5](#) [6609030-6](#) [6609973-2](#) [D30A](#) [7-1609090-5](#) [F2810](#) [F4456A](#) [F7382Z](#) [F7863Z](#) [FAHAV3100ZC000](#) [806276](#) [FN2020B-1-06](#) [FN2080B-10-06](#) [FN2410H-32-33](#) [FN2410H-80-34](#) [FP144](#) [FS4153-20-06](#) [FS4353-500-99](#) [12-MMB-030-11-D](#) [DB4-393](#) [15811T200](#)
[20B1](#) [LC630](#) [2B1](#) [1609080-2](#) [1609993-8](#) [1-6609070-1](#) [F1100AA02](#) [F1150CC10](#) [F1500CA10](#) [F1500CA15](#) [F4041Z](#) [F7585E](#) [1B1](#)
[FN2070A-16-06](#) [FN2090A-20-06](#) [FN2090B-12-06](#) [FN2090Z-1-06](#) [FN2410H-25-33](#) [FN2410H-60-34](#) [FN2410H-8-44](#) [FN2412H-8-44](#)
[FN323B-6-01](#) [FN3258H-130-35](#) [FN610R-3-06](#) [20EHQ7](#) [20EHZ7](#) [20K1](#) [30B6](#)