

Voltage selector switch, 2 stages, series-parallel, PCB mounting



See below:

Approvals and Compliances

Description

- Voltage Selector , 2 stage
- Series-parallel connections
- PCB terminals

References

Alternative: version for panel mounting [SWA1 \(Frontpl\)](#)

Weblinks

[pdf data sheet](#), [html datasheet](#), [General Product Information](#), [Approvals](#), [Distributor-Stock-Check](#), [Detailed request for product](#)

Technical Data

Ratings	IEC: 6.3 A / 250 VAC; 50 Hz	Solderability	235 °C / 2 sec acc. to IEC 60068-2-20, Test Ta, method 1	
	UL: 6.3 A / 250 VAC; 60 Hz		Resistance to Soldering Heat	260 °C / 5 sec acc. to IEC 60068-2-20, Test Tb, method 1A
	CSA: 6.3 A / 250 VAC; 60 Hz			Insulation Resistance
Mounting	PCB Mounting	Contact Resistance	< 10 mΩ at 20 mV	
Terminal	Solder, THT	Dielectric Strength	> 2kVAC between L-N > 4kVAC between L/N-PE (1min; 50Hz)	
Number of Stages	2	Clearance and Creepage Distance	> 3mm > 8mm between L/N-PE	
Lifetime	300 operating cycles (without load)	Resistance to Vibration	acc. to IEC 60068-2-6, test Fc	
Degree of Protection	from front side IP40			
Protection Class	Suitable for appliances with protection class II acc. to IEC 61140			
Allowable Operation Temperature	-40 °C to 85 °C			
Climatic Category	25/85/21 acc. to IEC 60068-1			
Material: Socket	Thermoplastic, black, UL 94V-0			
Weight	3.9 g			

Approvals and Compliances

Detailed information on product approvals, code requirements, usage instructions and detailed test conditions can be looked up in [Details about Approvals](#)

SCHURTER products are designed for use in industrial environments. They have approvals from independent testing bodies according to national and international standards. Products with specific characteristics and requirements such as required in the automotive sector according to IATF 16949, medical technology according to ISO 13485 or in the aerospace industry can be offered exclusively with customer-specific, individual agreements by SCHURTER.

Approvals



The approval mark is used by the testing authorities to certify compliance with the safety requirements placed on electronic products.

Approval Reference Type: SWA2

Approval Logo	Certificates	Certification Body	Description
	VDE Approvals	VDE	Certificate Number:
	UL Approvals	UL	UL File Number: E72661



Product standards

Product standards that are referenced

Organization	Design	Standard	Description
	Designed according to	UL 508	Industrial control equipment
	Designed according to	CSA C22.2 no. 14	Fuseholder general requirements



Application standards

Application standards where the product can be used

Organization	Design	Standard	Description
	Designed for applications acc.	IEC/UL 62368-1	IEC 62368-1 includes the basic requirements for safety of audio, video, information technology and office equipment.
	Designed for applications acc.	IEC 60335-1	Safety of electrical appliances for household and similar purposes. Meets the requirements for appliances in unattended use. This includes the enhanced requirements of glow wire tests acc. to IEC 60695-2-11 or -12 & -13.

Compliances

The product complies with following Guide Lines

Identification	Details	Initiator	Description
	CE declaration of conformity	SCHURTER AG	The CE marking declares that the product complies with the applicable requirements laid down in the harmonisation of Community legislation on its affixing in accordance with EU Regulation 765/2008.
	REACH	SCHURTER AG	On 1 June 2007, Regulation (EC) No 1907/2006 on the Registration, Evaluation, Authorization and Restriction of Chemicals 1 (abbreviated as "REACH") entered into force.

Dimension [mm]

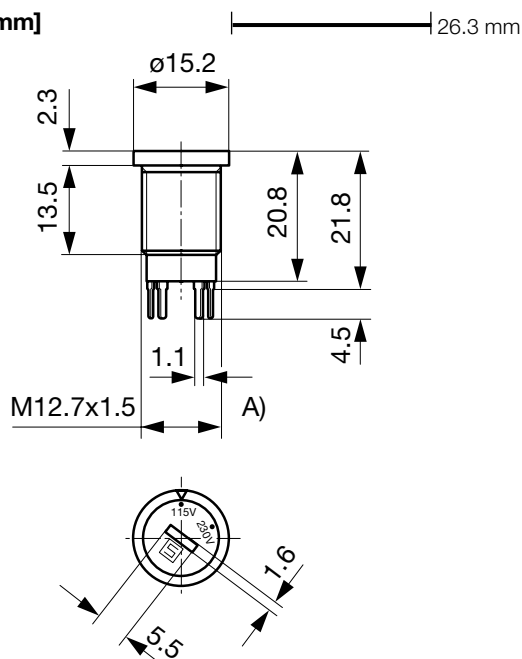

Drilling diagram

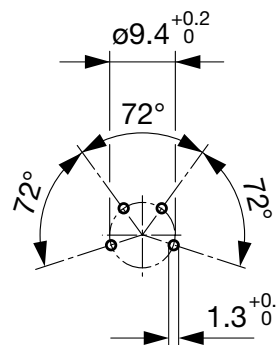

A) double start thread

Diagrams

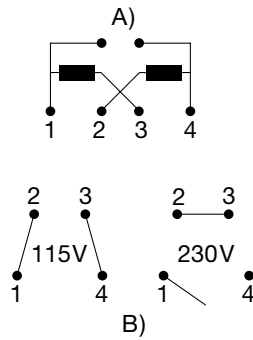

A) Power mains

B) Internal contact arrangement for series-parallel connection

All Variants

Letterings		Order Number
Stage 1	Stufe 2	
110	220	0033.4601
120	240	0033.4603
115	230	0033.4604
230	240	0033.4610
		0033.4614
120	230	0033.4615
100	230	0033.4619

Most Popular.

Availability for all products can be searched real-time: <https://www.schurter.com/en/Stock-Check/Stock-Check-SCHURTER>

Packaging Unit 100 Pcs

Accessories

Description



Nut for fuse holder
 Mounting accessories for fuse holder

X-ON Electronics

Largest Supplier of Electrical and Electronic Components

Click to view similar products for [Fuses with Leads \(Through Hole\)](#) category:

Click to view products by [Schurter](#) manufacturer:

Other Similar products are found below :

[89096-013](#) [89096-015](#) [A170100400](#) [BKPCH-5-R](#) [252010](#) [252.062](#) [SR-5H-5A-BK](#) [SS-5-800MA-AP](#) [SS-5F-3.15A-AP](#) [252004](#) [263.750](#)
[LKB-3](#) [0252001.M-](#) [0471005.MAT1L](#) [0473004.MAT1L](#) [0473.750HAT1L](#) [0471002.MAT1L](#) [0471.500MAT1L](#) [0491002.MAT1](#)
[0473001.HAT1L](#) [0473002.HAT1L](#) [0473.500HAT1L](#) [SS-5-1.6A-AP](#) [SS-5F-2.5A-AP](#) [SR-5H-2.5A-AP](#) [SS-5-6.3A-BK](#) [BK-AGC-2-1-2-R](#) [BK-](#)
[GMA-8-R](#) [BK-GMD-4-R](#) [BK-GMT-4A](#) [BK-PCD-5-R](#) [BK-C520-5-R](#) [BK-S500-500-R](#) [BK-SFE-20](#) [GMQ-3-2-10](#) [GLX-12](#) [PCB-34-R](#) [PCH-](#)
[12-R](#) [SR-5H-4A-AP](#) [RST 5-AMMO](#) [PCF-1/2-R](#) [SR-5H-3.15A-BK](#) [SR-5H-2A-BK](#) [047101.5MAT1L](#) [0471003.MAT1L](#) [GFA-12](#) [89096-005](#)
[SR-5F-1-6A-BK](#) [31232](#) [31236](#)