

Circuit Breaker for Equipment thermal, Drop-in type, Reset type, Quick connect terminals



Description

- Drop-in type
- Thermal circuit breaker
- 1-pole
- Reset type
- Quick connect terminals 6.3 x 0.8 mm

Unique Selling Proposition

- Compact design
- Positively trip-free release
- Available with cover
- Different mounting possibilities

Standards

- Approval Reference Type: T11
- IEC 60934
- UL 1077
- CSA C22.2 No. 235
- GB 17701

Applications

- Power tools
- Household Equipment
- Power supplies and chargers
- Industrial appliances

Weblinks

[pdf datasheet](#), [html-datasheet](#), [General Product Information](#), [Approvals](#), [CE declaration of conformity](#), [RoHS](#), [CHINA-RoHS](#), [REACH](#), [Distributor-Stock-Check](#), [Detailed request for product](#), [Product News](#)

Technical Data

Rated Voltage AC	240 V; 50/60 Hz
Rated Voltage DC	48 V
Rated current range AC	0.05 - 16 A
Conditional short circuit capacity	IEC: Inc, PC1, AC 240 V: 2 kA
Short circuit capacity I _{cn}	at I _n < 6.5 A/240 VAC : 8 x I _n at I _n ≥ 6.5 A/240 VAC : 96 A
Degree of Protection	from front side IP 40 acc. to IEC 60529
Dielectric Strength	50 Hz: > 1.5 kV Impulse 1.2/50 μs: > 2.5 kV
Insulation Resistance	500 VDC > 100 MΩ
Endurance typical	2 x I _r : 500 switching cycles
Endurance minimum	Reset type AC : 2 x I _r , cos φ 0.6 : DC : 2 x I _r , L/R = 2 - 3 ms : 50 switching cycles

Overload	IEC: min. 40 trips @ 6 x I _r , cos φ 0.6 UL / CSA: min. 50 trips @ 1.5 x I _r , cos φ 0.75
Ambient temperature	-5 °C to 60 °C
Vibration Resistance	± 1.5 mm @ 10 - 60 Hz acc. to IEC 60068-2-6, test Fc 5 G @ 60 - 500 Hz acc. to IEC 60068-2-6, test Fc
Shock Resistance	100 G / 6 ms acc. to IEC 60068-2-27, test Ea
Tripping Type	Thermal
Actuation Type	Reset type
Weight	ca. 10 g

Detailed information on product approvals, code requirements, usage instructions and detailed test conditions can be looked up in [General Product Information](#)

Dimension [mm]

T11-811 $\leq 7,5A$

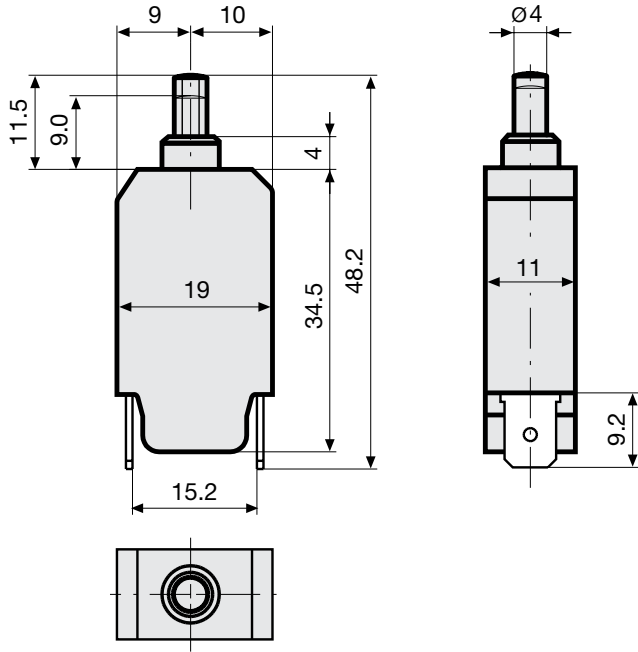

T11-811 $> 7,5 A$

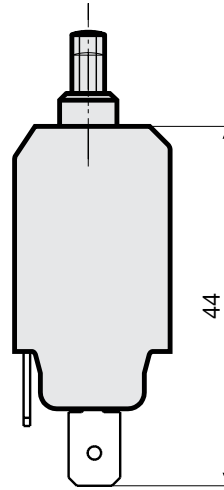

T11-811N

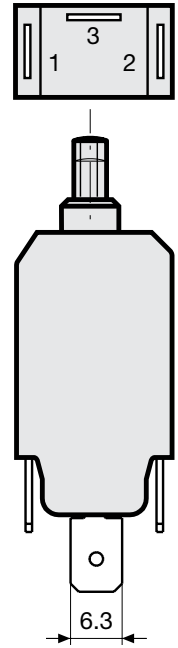

Diagrams

Rated current $\leq 7,5 A$

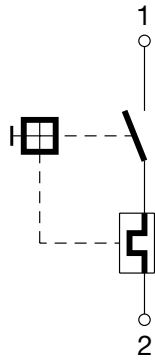

Rated current $> 7,5 A$

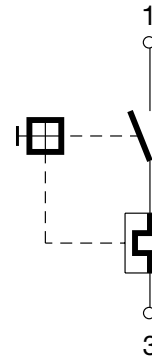

Shunt terminal T11-...N $\leq 6,5 A$

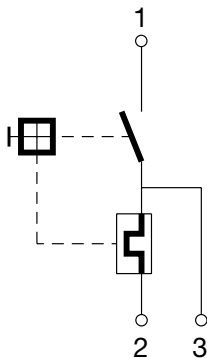

Typical internal resistance

Rated Current [A]	Internal Resistance [Ω]
0.05	380.000
0.50	5.200
1.00	1.350
2.00	0.300
3.00	0.130
4.00	0.080
5.00	0.040
6.00	0.040
7.00	0.020
8.00	0.012
9.00	0.012
10.00	0.011
11.00	0.0095
12.00	0.0095
13.00	0.0085
14.00	0.0085
15.00	0.0075
16.00	0.0075

Effect of ambient temperature

The units are calibrated for an ambient temperature of +23°C. To determine the rated current for a lower or higher ambient temperature, use a correction factor (typical value) from the table below:

Ambient temperature [°C]	Correction factor
-5	0.87
0	0.90
+10	0.95
+23	1.00
+30	1.04
+40	1.10
+50	1.15
+60	1.20

Example: Rated current = 5 A; Environmental temperature = 40 °C; --> Correction factor = 1.1; Resulting current = 5.5 A --> Found to next higher rated current: 6 A

Time-Current-Curves

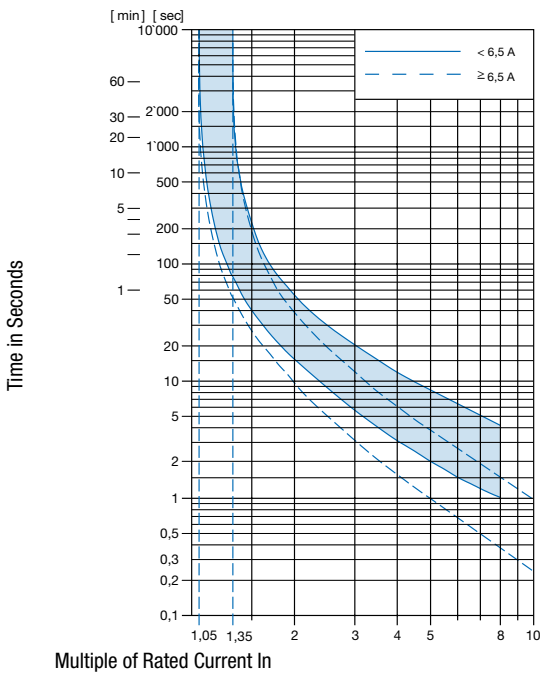

Reference Temperature +23°

Config. Code

T11 - 1 2 3 A B - 1.23

The characters are placeholders for the correspondingly keys of selections from the key tables.

T11 - **1** 2 3 A B - 1.23 = Mounting

Mounting	Configuration key
Drop-in type	8

T11 - 1 **2** 3 A B - 1.23 = Actuation Type

Actuation Type	Configuration key
Reset type	1

T11 - 1 2 **3** A B - 1.23 = Terminal

Terminal	Configuration key
Quick connect terminal 6.3x0.8mm	1

T11 - 1 2 3 **A** B - 1.23 = Shunt terminal

Shunt terminal	Configuration key
Shunt terminal	N

T11 - 1 2 3 A **B** - 1.23 = Setting indication

Setting indication	Configuration key
Setting indication	R

T11 - 1 2 3 A B - **1.23** = Rated current

Rated current	Configuration key
0.05 A	0.05
0.1 A	0.1
0.15 A	0.15
0.2 A	0.2
0.3 A	0.3
0.4 A	0.4
0.5 A	0.5
0.6 A	0.6
0.7 A	0.7
0.8 A	0.8
0.9 A	0.9
1.0	1
1.1 A	1.1
1.2 A	1.2
1.3 A	1.3
1.4 A	1.4
1.5 A	1.5
1.6 A	1.6
1.7 A	1.7
1.8 A	1.8
1.9 A	1.9
2.0 A	2

Other rated currents on request

Rated current	Configuration key	Rated current	Configuration key
2.1 A	2.1	7.0 A	7
2.3 A	2.3	7.5 A	7.5
2.5 A	2.5	8.0 A	8
2.8 A	2.8	8.5 A	8.5
3.0 A	3	9.0 A	9
3.3 A	3.3	9.5 A	9.5
3.5 A	3.5	10.0 A	10
4.0 A	4	11.0 A	11
4.5 A	4.5	12.0 A	12
5.0 A	5	13.0 A	13
5.5 A	5.5	14.0 A	14
6.0	6	15.0 A	15
6.5 A	6.5	16.0 A	16

Other rated currents on request

Variants

Rated current	Construction variants		Config. Code	Order Number
	Shunt terminal	Setting indication		
3.0 A			T11-811-3	4400.0112
5.0 A			T11-811-5	4400.0114
5.5 A			T11-811-5.5	4400.0120
2.5 A			T11-811-2.5	4400.0178
6.0			T11-811-6	4400.0179

Availability for all products can be searched real-time:<http://www.schurter.com/en/Stock-Check/Stock-Check-SCHURTER>

Packaging Unit 100 Pcs

Accessories

Description



T-Line Accessories
Accessories to T-Line

X-ON Electronics

Largest Supplier of Electrical and Electronic Components

Click to view similar products for [Circuit Breakers](#) category:

Click to view products by [Schurter](#) manufacturer:

Other Similar products are found below :

[LUGZX66-1-61-20.0-44](#) [M39019/01-201](#) [M39019/01-201S](#) [M39019/01-221](#) [M39019/01-323](#) [M39019/01-333](#) [M39019/01-336](#) [M39019/02-248](#) [M39019/02-311](#) [M39019/02-316](#) [M39019/04-249S](#) [M39019/05-246S](#) [M39019/06-254S](#) [M55629/1-016](#) [M55629/1-018](#) [M55629/1-021](#) [M55629/1-033](#) [M55629/1-036](#) [M55629/1-046](#) [M55629/1-048](#) [M55629/1-058](#) [M55629/1-067](#) [M55629/1-070](#) [M55629/1-079](#) [M55629/1-084](#) [M55629/1-085](#) [M55629/1-101](#) [M55629/1-109](#) [M55629/11-102](#) [M55629/1-120](#) [M55629/12-045](#) [M55629/12-046](#) [M55629/1-330](#) [M55629/1-366](#) [M55629/1-387](#) [M55629/1-401](#) [M55629/1-450](#) [M55629/2-022](#) [M55629/2-030](#) [M55629/2-072](#) [M55629/2-082](#) [M55629/2-099](#) [M55629/2-101](#) [M55629/2-102](#) [M55629/21-BM-BM](#) [M55629/21-HM-HM](#) [M55629/21-NS-NS](#) [M55629/22-NR-NR-NR](#) [M55629/22-RS-RS-RS](#) [M55629/2-347](#)