

Circuit Breaker for Equipment thermal-magnetic, Flange type, Manual ON/OFF, Quick connect terminals



See below:

Approvals and Compliances

Description

- Flange type
- TMF12-211 - Thermal-magnetic circuit breaker
- 1-pole
- Manual ON/OFF type
- Insensitive to shock or vibration
- Quick connect terminals 6.3 x 0.8 mm

Unique Selling Proposition

- Tripping characteristic Fast or Slow
- Positively trip-free release
- Available with cover
- Different mounting possibilities

Applications

- Power supplies
- Uninterruptible power supply
- Power tools
- Household appliances

Weblinks

[pdf data sheet](#), [html datasheet](#), [General Product Information](#), [Distributor-Stock-Check](#), [Detailed request for product](#), [Product News](#)

Technical Data

| | |
|--|---|
| Rated Voltage AC | AC 240 VAC |
| Rated Voltage DC | 28 VDC |
| Rated current range AC | 0.05 - 15 A , see approbations |
| Conditional short circuit capacity Inc | IEC 60934: PC1, AC 240 V: 1 kA |
| Short circuit capacity Icn | IEC 60934: AC 240 V : 200 A AC/DC 28 V : 400 A |
| Degree of Protection | front side IP40 acc. to IEC 60529 |
| Dielectric Strength | 50Hz: > 1.5 kV Impulse 1.2/50 µs: > 2.5 kV |
| Insulation Resistance | 500 VDC > 100 MΩ |
| Endurance typical | 2 x Ir: 5000 switching cycles |
| Endurance minimum | Manual ON/OFF type AC : 2 x Ir , cos φ 0.6 : |
| | DC : 2 x Ir , L/R = 2 - 3 ms : 5000 switching cycles |

| | |
|---------------------------|---|
| Overload | IEC: min. 40 trips @ 6 x Ir, cos φ 0.6 UL / CSA: min. 50 trips @ 1.5 x Ir, cos φ 0.75 |
| Allowable Operation Temp. | -5 °C to 60 °C |
| Vibration Resistance | ± 1.5 mm @ 10 - 60 Hz acc. to IEC 60068-2-6, test Fc 10 G @ 60 - 500 Hz acc. to IEC 60068-2-6, test Fc |
| Shock Resistance | 100 G / 6ms acc. to IEC 60068-2-27, test Ea |
| Tripping Type | Thermal-Magnetic |
| Actuation Type | Manual ON/OFF |
| Weight | ca. 10g |

Approvals and Compliances



Detailed information on product approvals, code requirements, usage instructions and detailed test conditions can be looked up in [Details about Approvals](#)

SCHURTER products are designed for use in industrial environments. They have approvals from independent testing bodies according to national and international standards. Products with specific characteristics and requirements such as required in the automotive sector according to IATF 16949, medical technology according to ISO 13485 or in the aerospace industry can be offered exclusively with customer-specific, individual agreements by SCHURTER.

Approvals



The approval mark is used by the testing authorities to certify compliance with the safety requirements placed on electronic products.

Approval Reference Type: TM12

| Approval Logo | Certificates | Certification Body | Description |
|--|-------------------------------|--------------------|--|
|  | VDE Approvals | VDE | VDE Certificate Number: 99673 |
|  | UL Approvals | UL | UL File Number: E71572 |
|  | CSA Approvals | CSA | CSA Certification Record: LR 37712 |
|  | CCC Approvals | CCC | CCC Certificate Number: 2020970307003504 |

Product standards

Product standards that are referenced

| Organization | Design | Standard | Description |
|--|-----------------------|-----------|---|
|  | Designed according to | IEC 60934 | Circuit-breakers for equipment (CBE) |
|  | Designed according to | UL 1077 | Standard for Supplementary Protectors for Use in Electrical Equipment |
|  | Designed according to | GB 17701 | Circuit-breaker for equipment |





Application standards

Application standards where the product can be used

| Organization | Design | Standard | Description |
|---|--------------------------------|----------------|---|
|  | Designed for applications acc. | IEC/UL 62368-1 | Audio/video, information and communication technology equipment - Part 1: Safety requirements |

Compliances

The product complies with following Guide Lines

| Identification | Details | Initiator | Description |
|--|--|-------------|---|
|  | CE declaration of conformity | SCHURTER AG | The CE marking declares that the product complies with the applicable requirements laid down in the harmonisation of Community legislation on its affixing in accordance with EU Regulation 765/2008. |
|  | UKCA declaration of conformity | SCHURTER AG | The UKCA marking declares that the product complies with the applicable requirements laid down in the British Amendment of Regulation (EC) 765/2008. |
|  | RoHS | SCHURTER AG | Directive RoHS 2011/65/EU, Amendment (EU) 2015/863 |
|  | China RoHS | SCHURTER AG | The law SJ / T 11363-2006 (China RoHS) has been in force since 1 March 2007. It is similar to the EU directive RoHS. |
|  | REACH | SCHURTER AG | On 1 June 2007, Regulation (EC) No 1907/2006 on the Registration, Evaluation, Authorization and Restriction of Chemicals 1 (abbreviated as "REACH") entered into force. |

Dimension [mm]
 TMx12-111

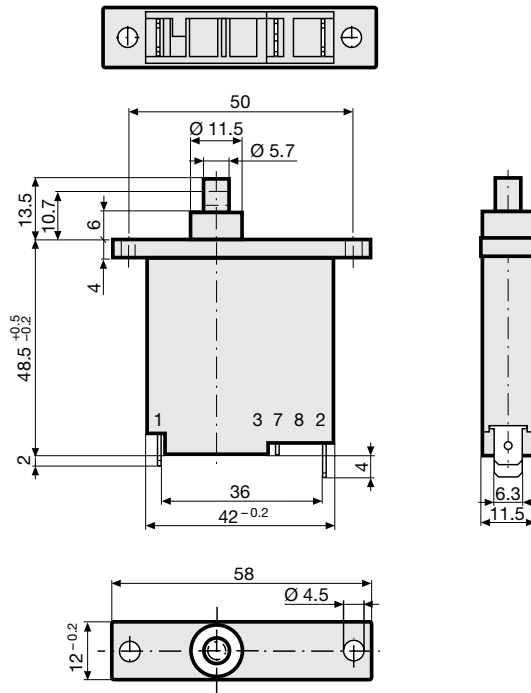

TMx12-111SN

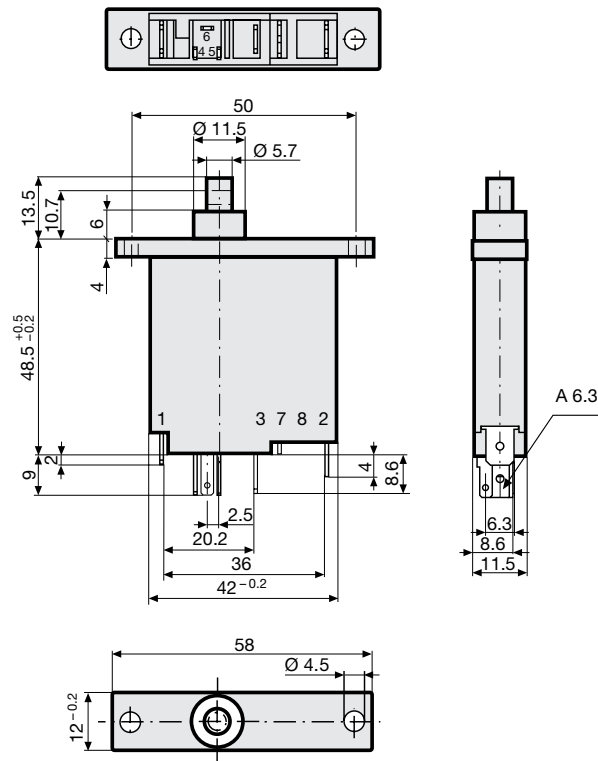

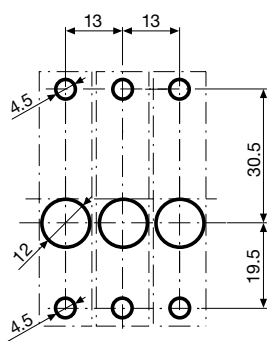

Installation from rear

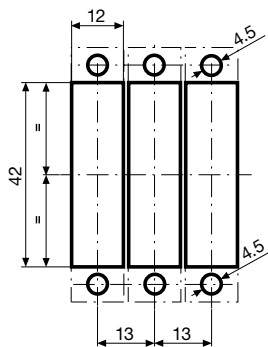

Installation from front

Diagrams

TM12-...

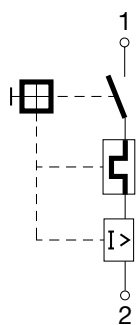

TM12-...N

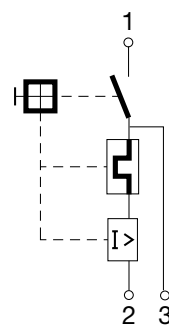

TM12-...S

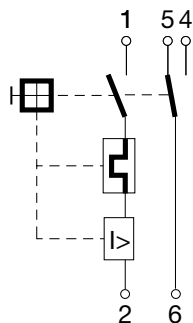

TM12-...SN

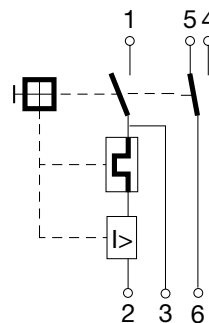

| Approval | Main circuit | Main circuit | | | Auxiliary circuit | | |
|----------|-------------------|---------------|------------------|------------------|-------------------|------------------|------------------|
| | | Rated current | Rated Voltage AC | Rated Voltage DC | Rated current | Rated Voltage AC | Rated Voltage DC |
| | UL 1077 | 0.05...15 A | 240 V | 28 V | 2 A | 120 V | - |
| | CSA C22.2 No. 235 | | | | 3 A | - | 28 V |
| | CSA C22.2 No. 235 | 0.05...16 A | 240 V | 28 V | 1 A | 240 V | - |
| | EN 60934 | 0.05...16 A | 240 V | 28 V | 1 A | 240 V | 28 V |
| | EN 60934 | 0.05...16 A | 240 V | 28 V | 1 A | 240 V | 28 V |
| | GB 17701 | 0.05...16 A | 240 V | 28 V | 1 A | 240 V | 28 V |

Typical internal resistance TMF12

| Rated Current [A] | Internal Resistance [Ω] |
|-------------------|----------------------------------|
| 0.05 | 335.00 |
| 0.50 | 4.37 |
| 1.00 | 1.23 |
| 2.00 | 0.369 |
| 3.00 | 0.181 |
| 4.00 | 0.097 |
| 5.00 | 0.055 |
| 6.00 | 0.044 |
| 7.00 | 0.0231 |
| 8.00 | 0.0227 |
| 9.00 | 0.0142 |
| 10.00 | 0.0123 |
| 11.00 | 0.012 |
| 12.00 | 0.012 |
| 13.00 | 0.0108 |
| 14.00 | 0.0091 |
| 15.00 | 0.0089 |
| 16.00 | 0.0071 |

Typical internal resistance TMT12

| Rated Current [A] | Internal Resistance [Ω] |
|-------------------|----------------------------------|
| 0.05 | 260.00 |
| 0.50 | 4.03 |
| 1.00 | 1.006 |
| 2.00 | 0.323 |
| 3.00 | 0.161 |
| 4.00 | 0.086 |
| 5.00 | 0.0494 |
| 6.00 | 0.0396 |
| 7.00 | 0.0257 |
| 8.00 | 0.0249 |
| 9.00 | 0.0129 |
| 10.00 | 0.0112 |
| 11.00 | 0.0111 |
| 12.00 | 0.0111 |
| 13.00 | 0.0109 |
| 14.00 | 0.0092 |
| 15.00 | 0.0090 |
| 16.00 | 0.0075 |

Effect of ambient temperature

The units are calibrated for an ambient temperature of +23°C. To determine the rated current for a lower or higher ambient temperature, use a correction factor (typical value) from the table below:

| Ambient Temperature [°C] | Correction factor |
|--------------------------|-------------------|
| -5 | 0.87 |
| 0 | 0.90 |
| 10 | 0.95 |
| 23 | 1.00 |
| 30 | 1.05 |
| 40 | 1.12 |
| 50 | 1.20 |
| 60 | 1.30 |

Example: Rated current = 5 A, Environmental temperature = 50 °C, --> Correction factor = 1.2, Resulting current = 6.0 A

Time-Current-Curves

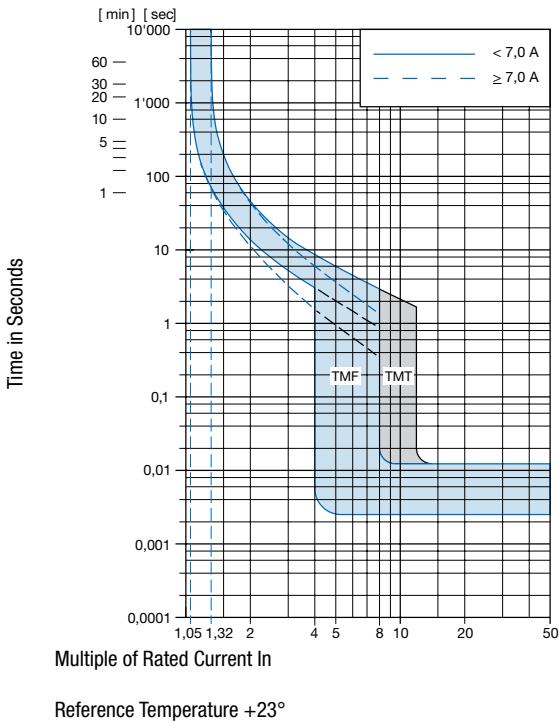

Config. Code

TM F 12 - 1 2 3 A B C - 1.23

The characters are placeholders for the correspondingly keys of selections from the key tables.

TM **F** 12 - 1 2 3 A B C - 1.23 = Magnetic release range

| Magnetic release range | Configuration key |
|------------------------|-------------------|
| Fast | F |
| Slow | T |

TM F 12 - **1** 2 3 A B C - 1.23 = Mounting

| Mounting | Configuration key |
|----------------------|-------------------|
| Screwflange mounting | 1 |

TM F 12 - 1 **2** 3 A B C - 1.23 = Actuation Type

| Actuation Type | Configuration key |
|---------------------------|-------------------|
| Manual ON/OFF (push/push) | 2 |

TM F 12 - 1 2 **3** A B C - 1.23 = Terminal

| Terminal | Configuration key |
|----------------------------------|-------------------|
| Quick connect terminal 6.3x0.8mm | 1 |

TM F 12 - 1 2 3 **A** B C - 1.23 = Auxiliary contact

| Auxiliary contact | Configuration key |
|-------------------|-------------------|
| Auxiliary contact | S |

TM F 12 - 1 2 3 A **B** C - 1.23 = Shunt terminal

| Shunt terminal | Configuration key |
|----------------|-------------------|
| Shunt terminal | N |

TM F 12 - 1 2 3 A B **C** - 1.23 = Setting indication

| Setting indication | Configuration key |
|--------------------|-------------------|
| Setting indication | R |

TM F 12 - 1 2 3 A B C - **1.23** = Rated current

| Rated current | Configuration key |
|---------------|-------------------|
| 0.05 A | 0.05 |
| 0.1 A | 0.1 |
| 0.15 A | 0.15 |
| 0.2 A | 0.2 |
| 0.3 A | 0.3 |
| 0.4 A | 0.4 |
| 0.5 A | 0.5 |
| 0.6 A | 0.6 |
| 0.7 A | 0.7 |
| 0.8 A | 0.8 |
| 0.9 A | 0.9 |
| 1.0 | 1 |
| 1.1 A | 1.1 |
| 1.2 A | 1.2 |
| 1.3 A | 1.3 |

Other rated currents on request

| Rated current | Configuration key | Rated current | Configuration key |
|---------------------------------|-------------------|---------------------------------|-------------------|
| 1.4 A | 1.4 | 5.0 A | 5 |
| 1.5 A | 1.5 | 5.5 A | 5.5 |
| 1.6 A | 1.6 | 6.0 | 6 |
| 1.7 A | 1.7 | 6.5 A | 6.5 |
| 1.8 A | 1.8 | 7.0 A | 7 |
| 1.9 A | 1.9 | 7.5 A | 7.5 |
| 2.0 A | 2 | 8.0 A | 8 |
| 2.1 A | 2.1 | 8.5 A | 8.5 |
| 2.3 A | 2.3 | 9.0 A | 9 |
| 2.5 A | 2.5 | 9.5 A | 9.5 |
| 2.8 A | 2.8 | 10.0 A | 10 |
| 3.0 A | 3 | 11.0 A | 11 |
| 3.3 A | 3.3 | 12.0 A | 12 |
| 3.5 A | 3.5 | 13.0 A | 13 |
| 4.0 A | 4 | 14.0 A | 14 |
| 4.5 A | 4.5 | 15.0 A | 15 |
| Other rated currents on request | | 16.0 A | 16 |
| | | Other rated currents on request | |

Variants

| Rated Current [A] | Construction variants | | | Config. Code | Order Number |
|-------------------|-----------------------|----------------|--------------------|---------------|--------------|
| | Auxiliary contact | Shunt terminal | Setting indication | | |
| 1 | | | | TMF12-121-1 | 4410.0552 |
| 1.4 | | | | TMF12-121-1.4 | 4410.0611 |
| 5 | | | | TMT12-121-5 | 4410.0199 |
| 6 | | | | TMT12-121-6 | 4410.0562 |
| 13 | | | ● | TMT12-121R-13 | 4410.0811 |
| 15 | | | | TMT12-121-15 | 4410.0098 |
| 16 | | | | TMF12-121-16 | 4410.0779 |

Availability for all products can be searched real-time: <https://www.schurter.com/en/Stock-Check/Stock-Check-SCHURTER>

Packaging Unit 20 Pcs

X-ON Electronics

Largest Supplier of Electrical and Electronic Components

Click to view similar products for [Circuit Breakers](#) category:

Click to view products by [Schurter](#) manufacturer:

Other Similar products are found below :

[LUGZX66-1-61-20.0-44](#) [M39019/01-201S](#) [M39019/01-221](#) [M39019/01-323](#) [M39019/01-333](#) [M39019/01-336](#) [M39019/02-248](#) [M39019/02-311](#) [M39019/02-316](#) [M39019/04-249S](#) [M39019/05-246S](#) [M39019/06-254S](#) [M55629/1-016](#) [M55629/1-018](#) [M55629/1-021](#) [M55629/1-033](#) [M55629/1-036](#) [M55629/1-046](#) [M55629/1-048](#) [M55629/1-058](#) [M55629/1-067](#) [M55629/1-070](#) [M55629/1-079](#) [M55629/1-084](#) [M55629/1-085](#) [M55629/1-101](#) [M55629/1-109](#) [M55629/11-102](#) [M55629/1-120](#) [M55629/12-045](#) [M55629/12-046](#) [M55629/1-330](#) [M55629/1-366](#) [M55629/1-387](#) [M55629/1-401](#) [M55629/1-450](#) [M55629/2-022](#) [M55629/2-030](#) [M55629/2-072](#) [M55629/2-082](#) [M55629/2-099](#) [M55629/2-101](#) [M55629/2-102](#) [M55629/21-BM-BM](#) [M55629/21-HM-HM](#) [M55629/21-NS-NS](#) [M55629/22-NR-NR-NR](#) [M55629/22-RS-RS-RS](#) [M55629/2-347](#) [M55629/2-401](#)