

IEC Connector C19, Rewireable, Angled



Rewireable connector



Example with assembled cable

C19



70 °C

See below:

[Approvals and Compliances](#)

Description

- Rewireable connector for cable 90° entry :
Screwing cable terminal
- Connector , Pin temperature 70 °C , Protection class I
- Screw clamps

Characteristics

- Suitable for use in equipment according to IEC/UL 62368-1

References

Substitute for type [1651](#)

Weblinks

[pdf data sheet](#), [html datasheet](#), [General Product Information](#), [Approvals](#), [Distributor-Stock-Check](#), [Accessories](#), [Detailed request for product](#)

Technical Data

| | | | |
|-----------------------------------|---|-------------------------|---|
| Ratings IEC | 16 A / 250 VAC; 50 Hz | Appliance inlet/-outlet | C19 acc. to IEC 60320-1 UL 60320-1, CSA C22.2 no. 60320-1 (for cold conditions) pin-temperature 70 °C, 16 A, Protection Class I |
| Ratings UL/CSA | 20 A / 250 VAC; 60 Hz | | |
| Dielectric Strength | > 2 kVAC between L-N > 2 kVAC between L/N-PE (1 min/50Hz) | | |
| Allowable Operation Temperature | -25 °C to 70 °C | | |
| Protection against electric shock | Suitable for appliances with protection class I acc. to IEC 61140 | | |
| Terminal | Screw | | |
| Material: Housing | Thermoplastic, black, UL 94V-0 | | |

Approvals and Compliances

Detailed information on product approvals, code requirements, usage instructions and detailed test conditions can be looked up in [Details about Approvals](#)

SCHURTER products are designed for use in industrial environments. They have approvals from independent testing bodies according to national and international standards. Products with specific characteristics and requirements such as required in the automotive sector according to IATF 16949, medical technology according to ISO 13485 or in the aerospace industry can be offered exclusively with customer-specific, individual agreements by SCHURTER.

Approvals



The approval mark is used by the testing authorities to certify compliance with the safety requirements placed on electronic products.

Approval Reference Type: 4790

| Approval Logo | Certificates | Certification Body | Description |
|---------------|-------------------------------|--------------------|--|
| | VDE Approvals | VDE | Certificate Number: 40040046 |
| | UL Approvals | UL | UL File Number: E96454 |
| | CCC Approvals | CCC | CCC Certificate Number: 2014010204709145 |

Product standards

Product standards that are referenced

| Organization | Design | Standard | Description |
|--|-----------------------|-----------------------|---|
|  | Designed according to | IEC 60320-1 | Appliance couplers for household and similar general purposes |
|  | Designed according to | UL 60320-1 | Standard for Attachment Plugs and Receptacles |
|  | Designed according to | CSA C22.2 no. 60320-1 | General Use Receptacles, Attachment Plugs, and Similar Wiring Devices |





Application standards

Application standards where the product can be used

| Organization | Design | Standard | Description |
|--|--------------------------------|----------------|---|
|  | Designed for applications acc. | IEC/UL 62368-1 | Audio/video, information and communication technology equipment - Part 1: Safety requirements |

Compliances

The product complies with following Guide Lines

| Identification | Details | Initiator | Description |
|--|--|-------------|---|
|  | CE declaration of conformity | SCHURTER AG | The CE marking declares that the product complies with the applicable requirements laid down in the harmonisation of Community legislation on its affixing in accordance with EU Regulation 765/2008. |
|  | UKCA declaration of conformity | SCHURTER AG | The UKCA marking declares that the product complies with the applicable requirements laid down in the British Amendment of Regulation (EC) 765/2008. |
|  | RoHS | SCHURTER AG | Directive RoHS 2011/65/EU, Amendment (EU) 2015/863 |
|  | China RoHS | SCHURTER AG | The law SJ / T 11363-2006 (China RoHS) has been in force since 1 March 2007. It is similar to the EU directive RoHS. |
|  | REACH | SCHURTER AG | On 1 June 2007, Regulation (EC) No 1907/2006 on the Registration, Evaluation, Authorization and Restriction of Chemicals 1 (abbreviated as "REACH") entered into force. |

Dimensions [mm]

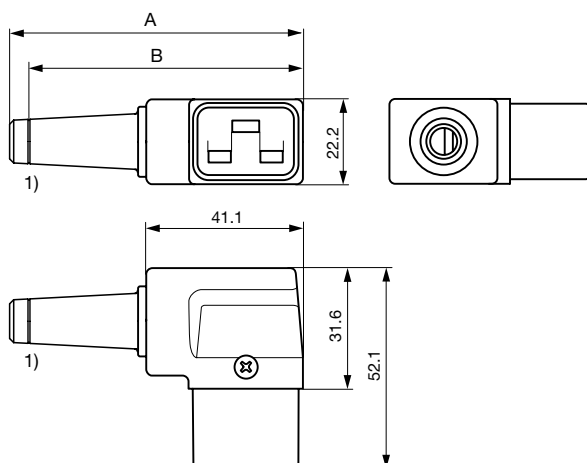

1) Cut strain relief 8 (10) mm here for 10 mm cable

A: Strain relief 8 mm: 76.1 mm

B: Strain relief 10 mm: 71.1 mm

All Variants

| Color | Recommended cable diameter | Max. wire size | L = Length of cable guard | Order Number |
|-------|----------------------------|--------------------------------------|---------------------------|--------------|
| black | 8 mm | 3 x 1.5 mm ² / 3 x 14 AWG | 76.1 mm | 4790.1100 |
| black | 10 mm | 3 x 1.5 mm ² / 3 x 14 AWG | 71.1 mm | 4790.1200 |

 Most Popular.

Availability for all products can be searched real-time: <https://www.schurter.com/en/Stock-Check/Stock-Check-SCHURTER>

Max. torque for screws: Terminals: 0.8 Nm, Cable clamps: 0.8 Nm, Cover: 0.5 Nm

Packaging unit

50 Pcs

Mating Inlets/Plugs

Category / Description

[Appliance Inlet Overview complete](#)



| | |
|--|------|
| 1601, Mounting: Screw, Solder terminal straight, IP20, Appliance Inlet, C20 | 1601 |
| 4793, Mounting: Snap-in, IP30, Appliance Inlet: IEC C20, Suitable for appliances with protection class I or II | 4793 |
| IEC Appliance Inlet C20, Screw-on Mounting, Front Side, Solder, Quick-connect or Screw Terminal | 1621 |

[IEC Inlet Filter Overview complete](#)



| | |
|--|------|
| IEC Appliance Inlet C20 with Filter, ECO design, front or rear side Mounting | 5130 |
| C20F, Mounting: Screw Front-/Rear-Side, Filter: Standard and Medical Version, Capacitor: X2, 16 A, Solder / quick connect / wires (stranded), prewired | C20F |
| C22F, Mounting: Screw Front-/Rear-Side, Filter: Standard and Medical Version, Capacitor: X2, 16 A, Solder / quick connect / wires (stranded), prewired | C22F |

[Plug Overview complete](#)



| | |
|--|------|
| 4796, Mounting: Power Cord, Cable, Plug: IEC I | 4796 |
| 4789, Mounting: Power Cord, Screw, Plug: IEC I | 4789 |

[Power Entry Module Overview complete](#)



| | |
|--|------|
| EC11, Mounting: Screw, Rocker switch: non-illuminated or illuminated 2-pole, Appliance Inlet IEC C20, Quick connect terminals 6.3 x 0.8 mm, prewired | EC11 |
|--|------|

[Power Entry Module with line filter Overview complete](#)



| | |
|--|------|
| IEC Appliance Inlet C20 with Filter, Circuit Breaker TA45 (recessed) | EF12 |
|--|------|

X-ON Electronics

Largest Supplier of Electrical and Electronic Components

Click to view similar products for [AC Power Entry Modules](#) category:

Click to view products by [Schurter](#) manufacturer:

Other Similar products are found below :

[0098.0050](#) [6167.0002](#) [6609100-2](#) [7-6609955-2](#) [FKI2-50-6/M5](#) [FN361-6-06](#) [FN389-4-22](#) [FN9226B-6-02](#) [FN9233S1-10-06](#) [FN9233S1-8-06](#)
[FN9233S1B-8-06](#) [FN9233S1R-1-06](#) [FN9233S1R-12-06](#) [FN9233SB-1-06](#) [FN9233SB-12-06](#) [FN9233SB-8-06](#) [FN9233SR-10-06](#) [FN9244B-15-06HI](#) [FN9244EB-3-06](#) [FN9244EB-8-06](#) [FN9244ER-15-06](#) [FN9244ER-8-06](#) [FN9244ES1-8-06](#) [FN9244ESB-8-06](#) [FN9244R-12-06](#)
[FN9244S1-12-06](#) [FN9244S1R-3-06](#) [FN9244SB-8-06](#) [FN9244SR-6-06](#) [FN9244U-3-06](#) [FN9244U-8-06](#) [8-6609940-2](#) [PE00SSSXB](#) [Fuse-H-EUR-1](#) [Fuse-H-USA-1](#) [PM00XD000](#) [A-0701-HT-H](#) [15EJMS8](#) [1-6609941-2](#) [200JM6-2](#) [CA121003-6](#) [SK-1015\(F1-5\)](#) [161-R3015-E](#) [1-6609153-2](#) [FN323-1-05](#) [FN9233B-8-06](#) [FN9233EB-1-06](#) [FN9233ES1R-10-06](#) [FN9233R-12-06](#) [FN9233S-10-06](#)