

IEC Appliance Inlet C8 polarized, Snap-in Mounting, Front Side, Solder, Quick Connect or PCB Terminal



Snap-in mounting from front side
 Solder terminal for PCB
 Terminal vertical

C8 polarized



70 °C

See below:

[Approvals and Compliances](#)

Description

- Panel mount
- Snap-in mounting on PCB front side
- Appliance Inlet , Pin temperature 70 °C , Protection class II
- Solder / Quick Connect / PCB Terminal

Weblinks

[pdf data sheet](#), [html datasheet](#), [General Product Information](#), [Approvals](#), [Distributor-Stock-Check](#), [Accessories](#), [Detailed request for product](#)

Technical Data

Ratings IEC	2.5 A / 250 VAC; 50 Hz	Appliance inlet/-outlet	C8p acc. to IEC 60320-1
Ratings UL/CSA	2.5 A / 250 VAC; 60 Hz		UL 60320-1, CSA C22.2 no. 60320-1
	7 A / 125 VAC; 60 Hz		(for cold conditions) pin-temperature 70 °C, 2.5 A, Protection Class II
Dielectric Strength	> 1.5 kVAC between L-N > 3 kVAC between L/N-PE (1 min/50 Hz)		
Allowable Operation Temperature	-25 °C to 70 °C		
IP-Protection	front side IP20 acc. to IEC 60529		
Protection against electric shock	Suitable for appliances with protection class II acc. to IEC 61140		
Material: Housing	PA6, black / grey / white, UL 94V-0		

Approvals and Compliances

Detailed information on product approvals, code requirements, usage instructions and detailed test conditions can be looked up in [Details about Approvals](#)

SCHURTER products are designed for use in industrial environments. They have approvals from independent testing bodies according to national and international standards. Products with specific characteristics and requirements such as required in the automotive sector according to IATF 16949, medical technology according to ISO 13485 or in the aerospace industry can be offered exclusively with customer-specific, individual agreements by SCHURTER.

Approvals

The approval mark is used by the testing authorities to certify compliance with the safety requirements placed on electronic products.

Approval Reference Type: 2579

Approval Logo	Certificates	Certification Body	Description
	VDE Approvals	VDE	VDE Certificate Number: 40034368
	UL Approvals	UL	UL File Number: E96454

Product standards

Product standards that are referenced

Organization	Design	Standard	Description
	Designed according to	IEC 60320-1	Appliance couplers for household and similar general purposes
	Designed according to	UL 60320-1	Standard for Attachment Plugs and Receptacles
	Designed according to	CSA C22.2 no. 60320-1	General Use Receptacles, Attachment Plugs, and Similar Wiring Devices





Application standards

Application standards where the product can be used

Organization	Design	Standard	Description
	Designed for applications acc.	IEC/UL 62368-1	Audio/video, information and communication technology equipment - Part 1: Safety requirements

Compliances

The product complies with following Guide Lines

Identification	Details	Initiator	Description
	CE declaration of conformity	SCHURTER AG	The CE marking declares that the product complies with the applicable requirements laid down in the harmonisation of Community legislation on its affixing in accordance with EU Regulation 765/2008.
	UKCA declaration of conformity	SCHURTER AG	The UKCA marking declares that the product complies with the applicable requirements laid down in the British Amendment of Regulation (EC) 765/2008.
	RoHS	SCHURTER AG	Directive RoHS 2011/65/EU, Amendment (EU) 2015/863
	China RoHS	SCHURTER AG	The law SJ / T 11363-2006 (China RoHS) has been in force since 1 March 2007. It is similar to the EU directive RoHS.
	REACH	SCHURTER AG	On 1 June 2007, Regulation (EC) No 1907/2006 on the Registration, Evaluation, Authorization and Restriction of Chemicals 1 (abbreviated as "REACH") entered into force.

Dimensions [mm]

PCB

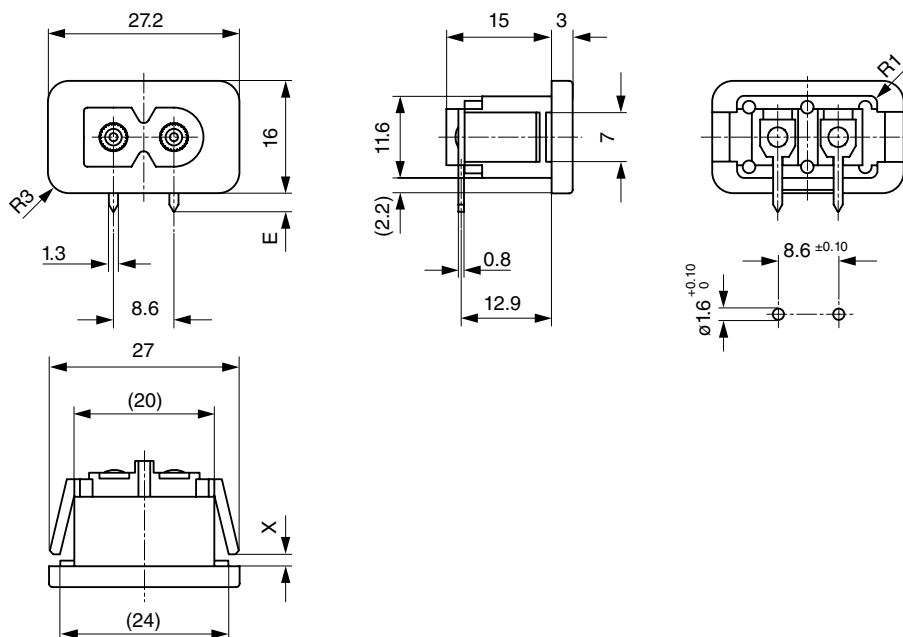

Panel thickness X = 1.0 / 1.5 / 2.0 / 2.5 / 3.0 mm

E: PCB terminal standard: 4.25 mm

E: PCB terminal short: 2.7 mm

E: PCB terminal long: 5.35 mm

Terminals orientation A

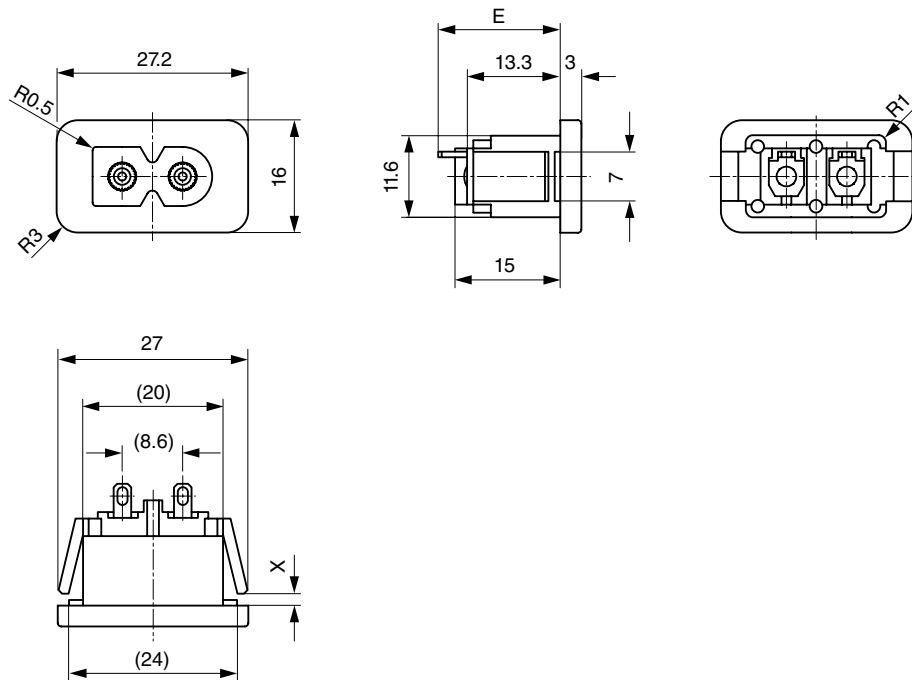

Panel thickness X = 1.0 / 1.5 / 2.0 / 2.5 / 3.0 mm
 E: Solder terminals short: 17.3 mm (L=4.8 mm)
 E: Solder terminals long: 21.0 mm (L=8.5 mm)
 E: Quick connect terminals 2.8x0.8 mm: 23.3 mm

Terminals orientation B

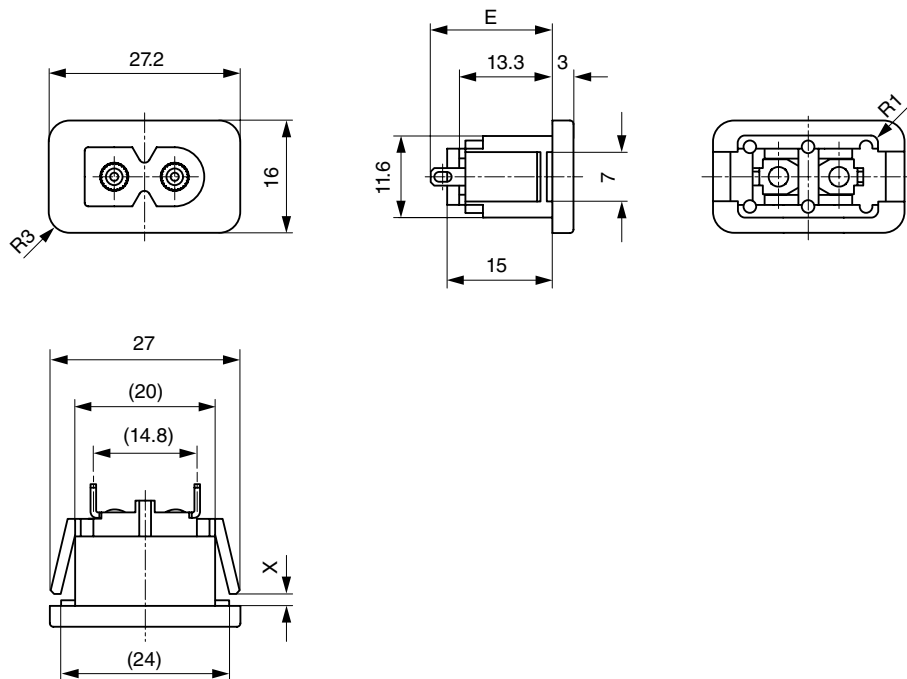

Panel thickness X = 1.0 / 1.5 / 2.0 / 2.5 / 3.0 mm
 E: Solder terminals short: 17.3 mm (L=4.8 mm)
 E: Solder terminals long: 21.0 mm (L=8.5 mm)
 E: Quick connect terminals 2.8x0.8 mm: 23.3 mm

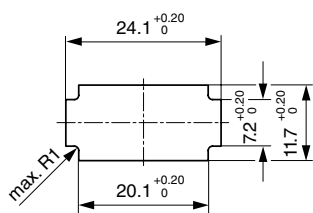

Panel cut-out for X = 1.0 mm

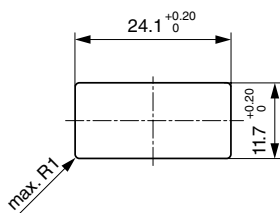

Panel cut-out for X = 1.5 / 2.0 / 2.5 / 3.0 mm

Config. Code











2579 - H - A B C 0 - D - E G F

The characters are placeholders for the correspondingly keys of selections from the key tables.

2579 - **H** - A B C 0 - D - E G F = Type

Type	Configuration key
protection class II	X

2579 - H - **A** B C 0 - D - E G F = Terminals

Terminal L	Configuration key
short solder terminal (L = 4.8 mm)	2 
long solder terminal (L = 8.5 mm)	3 
PCB-terminal standard (additional solder terminal)	4 
PCB-terminal short (additional solder terminal)	5 
PCB-terminal long (additional solder terminal)	6 
Blade terminal (2.8 x 0.8 mm)	7 
Blade terminal (4.8 x 0.8 mm)	8 
Blade terminal (6.3 x 0.8 mm)	9 
PCB-terminal (standard)	A 
PCB-terminal (short)	B 
PCB-terminal (long)	C 

2579 - H - A **B** C 0 - D - E G F = Terminals

Terminal N	Configuration key
short solder terminal (L = 4.8 mm)	2
long solder terminal (L = 8.5 mm)	3
PCB-terminal standard (additional solder terminal)	4
PCB-terminal short (additional solder terminal)	5
PCB-terminal long (additional solder terminal)	6
Blade terminal (2.8 x 0.8 mm)	7
Blade terminal (4.8 x 0.8 mm)	8
Blade terminal (6.3 x 0.8 mm)	9
PCB-terminal (standard)	A
PCB-terminal (short)	B
PCB-terminal (long)	C

Symbols similar as in table A

2579 - H - A B **C** 0 - D - E G F = Terminals

Terminal Ground	Configuration key
without terminal	0

Symbols similar as in table A

2579 - H - A B C 0 - **D** - E G F = Color

Color	Configuration key
Black	A
Grey	B
White	D

2579 - H - A B C 0 - D - **E** G F = Style

Style	Configuration key
snap-in (s=panel thickness)	4

2579 - H - A B C 0 - D - E **G** F = Dimension S

Dimension "S"

Configuration key

2579 - H - A B C 0 - D - E G F = Orientation of Terminals

10
15
20
25
30

Orientation of Terminals

Configuration key

horizontal	A
vertical	B

The dimension "S" is displayed in (1/10 mm). This information is also valid for the order code

All Variants

Terminals L / N	Orientation of Terminals	Color	Panel Thickness s [1/10 mm]	Config. Code	Order Number
short solder terminal (L = 4.8 mm)	vertical	Black	30	2579-X-2200-A-430B	6160.0140
PCB-terminal (standard)	horizontal	Black	30	2579-X-AA00-A-430A	6160.0141
short solder terminal (L = 4.8 mm)	horizontal	Black	30	2579-X-2200-A-430A	6160.0142
short solder terminal (L = 4.8 mm)	horizontal	Black	25	2579-X-2200-A-425A	6160.0145
short solder terminal (L = 4.8 mm)	vertical	Black	15	2579-X-2200-A-415B	6160.0150
short solder terminal (L = 4.8 mm)	vertical	Black	20	2579-X-2200-A-420B	6160.0151
short solder terminal (L = 4.8 mm)	vertical	Black	25	2579-X-2200-A-425B	6160.0152
short solder terminal (L = 4.8 mm)	horizontal	Black	15	2579-X-2200-A-415A	6160.0157
short solder terminal (L = 4.8 mm)	horizontal	Black	20	2579-X-2200-A-420A	6160.0158
PCB-terminal (standard)	horizontal	Black	15	2579-X-AA00-A-415A	6160.0159

The listed variants should be available from stock. Other versions on request www.schurter.com/contact

Availability for all products can be searched real-time: <https://www.schurter.com/en/Stock-Check/Stock-Check-SCHURTER>

Packaging unit

100 Pcs

X-ON Electronics

Largest Supplier of Electrical and Electronic Components

Click to view similar products for [AC Power Entry Modules](#) category:

Click to view products by [Schurter](#) manufacturer:

Other Similar products are found below :

[6167.0002](#) [6609100-2](#) [7-6609955-2](#) [FN361-6-06](#) [FN389-4-22](#) [FN9233S1-10-06](#) [FN9233S1-8-06](#) [FN9233S1B-8-06](#) [FN9233S1R-1-06](#)
[FN9233S1R-12-06](#) [FN9233SB-1-06](#) [FN9233SB-12-06](#) [FN9233SB-8-06](#) [FN9233SR-10-06](#) [FN9244B-15-06HI](#) [FN9244EB-3-06](#) [FN9244EB-8-06](#) [FN9244ER-15-06](#) [FN9244ER-8-06](#) [FN9244ES1-8-06](#) [FN9244ESB-8-06](#) [FN9244R-12-06](#) [FN9244S1-12-06](#) [FN9244S1R-3-06](#)
[FN9244SB-8-06](#) [FN9244SR-10-06](#) [FN9244SR-3-06](#) [FN9244SR-6-06](#) [FN9244U-3-06](#) [FN9244U-8-06](#) [PE00SSSXB](#) [Fuse-H-EUR-1](#)
[PM00XD000](#) [15EJMS8](#) [1-6609941-2](#) [200JM6-2](#) [CA121003-6](#) [SK-1015\(F1-5\)](#) [1-6609153-2](#) [FN323-1-05](#) [FN372-2-](#) [FN9233B-8-06](#)
[FN9233EB-1-06](#) [FN9233ES1R-10-06](#) [FN9233S-10-06](#) [FN9233S1B-10-06](#) [FN9233S1B-12-06](#) [FN9233S1B-6-06](#) [FN9233U-6-06](#) [FN9244-6-07](#)