

Shock-Safe Fuseholder, 5 x 20 mm, Fingergrip, Rear-Side, NF, IP 40 / IP 67



250 VAC · 1.5W/6.3A (NF)

See below:
[Approvals and Compliances](#)

Description

- Screw type fuse carrier

References

Last order date: 30.04.2021

Weblinks

[pdf data sheet](#), [html datasheet](#), [General Product Information](#), [Distributor-Stock-Check](#), [Detailed request for product](#), [Microsite](#)

Technical Data

Fuse-Link	5 x 20mm
Mounting	Panel mount, Rear Side
Attachment	Fixing Nut
Terminal	Solder
Rated Voltage	250VAC
Rated current	6.3A (NF)
Rated Power Acceptance IEC	1.5W / 6.3A @ Ta 23 °C
Degree of Protection	IP40 / IP67
Admissible Ambient Air Temp.	-40 °C to 85 °C
Climatic Category	40/085/21 acc. to IEC 60068-1
Material: Socket	Thermoset, black
Unit Weight	16 g
Storage Conditions	0 °C to 60 °C, max. 70% r.h.
Product Marking	Type, Rated Voltage, Rated current, HB1

Soldering Methods	Iron Soldering Profile
Contact Resistance	< mΩ at 100 mA
Resistance to Vibration	acc. to NF C 20-706 / IEC 60068-2-6, test Fc
Shocks	acc. to NF C 20-706 / IEC 60068-2-27
Bumps	acc. to NF C 20-729 / IEC 60068-2-29
Salt Mist	acc. to NF C 20-711 / IEC 60068-2-11
Dump Heat	acc. to NF C 20-604
Climatic Composite	acc. to NF C 20-619 Phases D and F
Admissible Torque on Fixing Nut	max 1.0Nm
Panel Thickness	max 4.5 mm

Approvals and Compliances

Detailed information on product approvals, code requirements, usage instructions and detailed test conditions can be looked up in [Details about Approvals](#)

SCHURTER products are designed for use in industrial environments. They have approvals from independent testing bodies according to national and international standards. Products with specific characteristics and requirements such as required in the automotive sector according to IATF 16949, medical technology according to ISO 13485 or in the aerospace industry can be offered exclusively with customer-specific, individual agreements by SCHURTER.

Approvals

The approval mark is used by the testing authorities to certify compliance with the safety requirements placed on electronic products.

Approval Reference Type: 23316P

Approval Logo	Certificates	Certification Body	Description
	LCIE Approvals	LCIE	Norme française

Product standards

Product standards that are referenced

Organization	Design	Standard	Description
	Designed according to		Contrôle de Conformité de Qualité (CCQ)





Application standards

Application standards where the product can be used

Organization	Design	Standard	Description
	Designed for applications acc.	IEC/UL 62368-1	Audio/video, information and communication technology equipment - Part 1: Safety requirements

Compliances

The product complies with following Guide Lines

Identification	Details	Initiator	Description
		SCHURTER AG	The CE marking declares that the product complies with the applicable requirements laid down in the harmonisation of Community legislation on its affixing in accordance with EU Regulation 765/2008.
	UKCA declaration of conformity	SCHURTER AG	The UKCA marking declares that the product complies with the applicable requirements laid down in the British Amendment of Regulation (EC) 765/2008.
	RoHS	SCHURTER AG	Directive RoHS 2011/65/EU, Amendment (EU) 2015/863
	China RoHS	SCHURTER AG	The law SJ / T 11363-2006 (China RoHS) has been in force since 1 March 2007. It is similar to the EU directive RoHS.
	REACH	SCHURTER AG	On 1 June 2007, Regulation (EC) No 1907/2006 on the Registration, Evaluation, Authorization and Restriction of Chemicals 1 (abbreviated as "REACH") entered into force.

Dimension [mm]

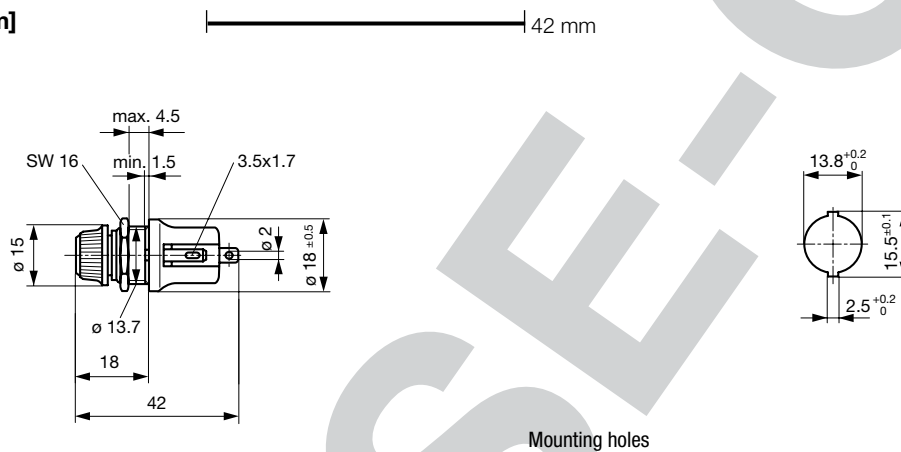

Mounting holes

All Variants

Holder	Cap	Degree of Protection	 GAM T1 NNO	Reference	Order Number
•	Fingergrip	IP40	•	23316P	7091.1510
•	Fingergrip	IP67		23316ERJJP	7091.1520

Availability for all products can be searched real-time: <https://www.schurter.com/en/Stock-Check/Stock-Check-SCHURTER>

Packaging Unit

Bulk (10 pcs.)

X-ON Electronics

Largest Supplier of Electrical and Electronic Components

Click to view similar products for [Fuse Holder](#) category:

Click to view products by [Schurter](#) manufacturer:

Other Similar products are found below :

[570-290-741P40](#) [570-290-751P40](#) [020417G](#) [020418E](#) [6R30A1B](#) [F600A3B](#) [80910030](#) [8601.2020](#) [G15A2SPQ](#) [9-3557-GP REV A](#) [HDJ-B](#)
[R6J30A3S](#) [HFH-1](#) [RF30A1S](#) [RF30A2B](#) [RF30A3SP](#) [15600-08-10](#) [BK/FHN19G](#) [BK/HHM](#) [BK/HKP-CCHH](#) [BK/HKP-JJ](#) [BK/HTJ-LES-](#)
[FUSE](#) [HMG-241](#) [HTJ-LES-FUSE](#) [C4044-1](#) [2086-1](#) [2193](#) [2602](#) [2650](#) [178.000100](#) [FHN31G1](#) [T30A2B](#) [G4PB8](#) [2660](#) [2799](#) [CQ-209V](#) [HKP-](#)
[CCHH](#) [R6F30A2S](#) [341001A](#) [345621A](#) [CVRMCC](#) [4202](#) [4407](#) [4408](#) [4413](#) [4423](#) [4532](#) [4537](#) [TSD1404-12](#) [BK/FHN31G1](#)