

Shock-Safe Fuseholder, 5 x 20 mm, Fingergrip, horizontal or vertical



250 VAC/DC · 1.3W/10A10A (UL/CSA)

See below:
[Approvals and Compliances](#)

Description

- Screw type fuse carrier
- PCB mounting horizontal or vertical

References

Last order date: 30.04.2021

Weblinks

[pdf data sheet](#), [html datasheet](#), [General Product Information](#), [Distributor-Stock-Check](#), [Detailed request for product](#), [Microsite](#)

Technical Data

Fuse-Link	5 x 20mm	Soldering Methods	Wave Soldering Profile
Mounting	PCB	Contact Resistance	< mΩ at 100 mA
Terminal	Solder THT	Resistance to Vibration	acc. to NF C 20-706 / IEC 60068-2-6, test Fc
Rated Voltage	250 VAC/DC	Shocks	acc. to NF C 20-706 / IEC 60068-2-27
Rated current	10 A (UL/CSA)	Bumps	acc. to NF C 20-729 / IEC 60068-2-29
Rated Power Acceptance IEC	1.3 W / 10 A @ Ta 23 °C		
Degree of Protection	IP40		
Protection Class	Suitable for appliances with protection class I or II acc. to IEC 61140		
Admissible Ambient Air Temp.	-40 °C to 85 °C		
Climatic Category	40/085/56 acc. to IEC 60068-1		
Material: Socket	Thermoset, black		
Material: Cap	Thermoplastic, black		
Unit Weight	6 g		
Storage Conditions	0 °C to 60 °C, max. 70% r.h.		
Product Marking	 , Type, Rated Voltage, Rated current, Certification marks		

Approvals and Compliances



Detailed information on product approvals, code requirements, usage instructions and detailed test conditions can be looked up in [Details about Approvals](#)

SCHURTER products are designed for use in industrial environments. They have approvals from independent testing bodies according to national and international standards. Products with specific characteristics and requirements such as required in the automotive sector according to IATF 16949, medical technology according to ISO 13485 or in the aerospace industry can be offered exclusively with customer-specific, individual agreements by SCHURTER.

Approvals

The approval mark is used by the testing authorities to certify compliance with the safety requirements placed on electronic products.

Approval Reference Type: 231409

Approval Logo	Certificates	Certification Body	Description
	UL Approvals	UL	UL File Number: E41738
	CSA Approvals	CSA	CSA Certification Record: LR 23151

GAM
T1

NNO

Product standards

Product standards that are referenced

Organization	Design	Standard	Description
	Designed according to	UL 4248-1	Industrial Control Equipment
	Designed according to	CSA C22.2 no. 4248.1	Industrial Control Equipment





Application standards

Application standards where the product can be used

Organization	Design	Standard	Description
	Designed for applications acc.	IEC/UL 62368-1	Audio/video, information and communication technology equipment - Part 1: Safety requirements

Compliances

The product complies with following Guide Lines

Identification	Details	Initiator	Description
		SCHURTER AG	The CE marking declares that the product complies with the applicable requirements laid down in the harmonisation of Community legislation on its affixing in accordance with EU Regulation 765/2008.
	UKCA declaration of conformity	SCHURTER AG	The UKCA marking declares that the product complies with the applicable requirements laid down in the British Amendment of Regulation (EC) 765/2008.
	RoHS	SCHURTER AG	Directive RoHS 2011/65/EU, Amendment (EU) 2015/863
	China RoHS	SCHURTER AG	The law SJ / T 11363-2006 (China RoHS) has been in force since 1 March 2007. It is similar to the EU directive RoHS.
	REACH	SCHURTER AG	On 1 June 2007, Regulation (EC) No 1907/2006 on the Registration, Evaluation, Authorization and Restriction of Chemicals 1 (abbreviated as "REACH") entered into force.

Dimension [mm]

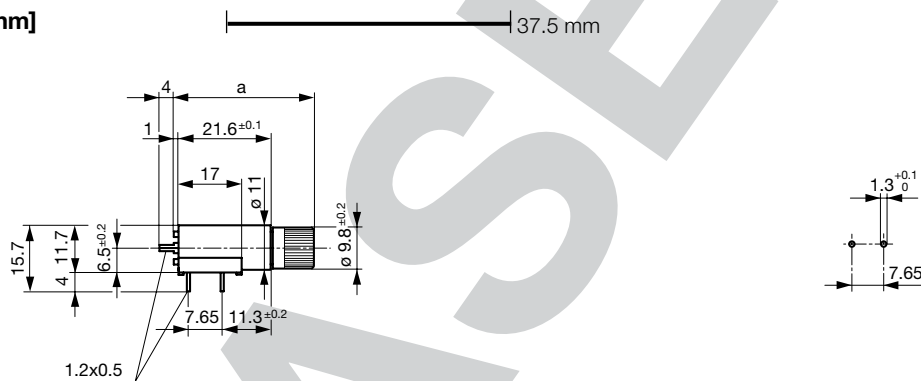

a = 33.5 Variants 7091.4210, 7091.4240 and 7091.4270
 a = 38.5 Variant 7091.4400

Drilling diagram

Packaging Unit

Bulk (10 pcs.)

X-ON Electronics

Largest Supplier of Electrical and Electronic Components

Click to view similar products for [Fuse Holder](#) category:

Click to view products by [Schurter](#) manufacturer:

Other Similar products are found below :

[570-290-741P40](#) [570-290-751P40](#) [020417G](#) [020418E](#) [6R30A1B](#) [F600A3B](#) [80910030](#) [8601.2020](#) [G15A2SPQ](#) [9-3557-GP REV A](#) [HDJ-B](#)
[R6J30A3S](#) [HFH-1](#) [RF30A2B](#) [RF30A3SP](#) [15600-08-10](#) [BK/FHN19G](#) [BK/HHM](#) [BK/HKP-CCHH](#) [BK/HKP-JJ](#) [BK/HTJ-LES-FUSE](#) [HMG-](#)
[241](#) [HTJ-LES-FUSE](#) [C4044-1](#) [2086-1](#) [2193](#) [2602](#) [2650](#) [178.000100](#) [FHN31G1](#) [T30A2B](#) [G4PB8](#) [2660](#) [2799](#) [CQ-209V](#) [HKP-CCHH](#)
[R6F30A2S](#) [341001A](#) [345621A](#) [CVRMCC](#) [4202](#) [4407](#) [4408](#) [4413](#) [4423](#) [4532](#) [4537](#) [TSD1404-12](#) [BK/FHN31G1](#) [BK/HC-5](#)