

Shock-Safe Fuseholder, 6.3 x 32 mm, Fingerrip, Rear-Side, NF



250 VAC · 2.5W/10A (NF)10A (UL/CSA)

See below:
[Approvals and Compliances](#)

Description

- Screw type fuse carrier

References

Last order date: 30.04.2021
 We recommend for new applications

Weblinks

[pdf data sheet](#), [html datasheet](#), [General Product Information](#), [Distributor-Stock-Check](#), [Detailed request for product](#), [Microsite](#)

Technical Data

Fuse-Link	6.3 x 32mm	Soldering Methods	Iron Soldering Profile
Mounting	Panel mount, Rear Side	Contact Resistance	< mΩ at 100 mA
Attachment	Fixing Nut	Resistance to Vibration	acc. to NF C 20-706 / IEC 60068-2-6, test Fc
Terminal	Solder	Shocks	acc. to NF C 20-706 / IEC 60068-2-27
Rated Voltage	250VAC	Bumps	acc. to NF C 20-729 / IEC 60068-2-29
Rated current	10A (NF), 10A (UL/CSA)	Salt Mist	acc. to NF C 20-711 / IEC 60068-2-11
Rated Power Acceptance IEC	2.5W / 10A @ Ta 23°C Admissible power acceptance at higher ambient temperature see derating curves	Dump Heat	acc. to NF C 20-604
Degree of Protection	IP40 / IP67	Climatic Composite	acc. to NF C 20-619 Phases D and F
Protection Class	Suitable for appliances with protection class I or II acc. to IEC 61140	Admissible Torque on Fixing Nut	max 1.2Nm
Admissible Ambient Air Temp.	-40°C to 85°C	Panel Thickness	max 5mm
Climatic Category	40/085/21 acc. to IEC 60068-1		
Material: Socket	Thermoset, black		
Unit Weight	19 g		
Storage Conditions	0°C to 60°C, max. 70% r.h.		
Product Marking	Type, Rated Voltage, Rated current, Certification marks, HB2		

Approvals and Compliances

Detailed information on product approvals, code requirements, usage instructions and detailed test conditions can be looked up in [Details about Approvals](#)

SCHURTER products are designed for use in industrial environments. They have approvals from independent testing bodies according to national and international standards. Products with specific characteristics and requirements such as required in the automotive sector according to IATF 16949, medical technology according to ISO 13485 or in the aerospace industry can be offered exclusively with customer-specific, individual agreements by SCHURTER.

Approvals



The approval mark is used by the testing authorities to certify compliance with the safety requirements placed on electronic products.

Approval Reference Type: 23312P

Approval Logo	Certificates	Certification Body	Description
	UL Approvals	UL	UR File Number: E41738
	CSA Approvals	CSA	CSA Certification Record: 23151
	LCIE Approvals	LCIE	Norme française

Product standards

Product standards that are referenced

Organization	Design	Standard	Description
	Designed according to	UL 4248-1	Industrial Control Equipment
	Designed according to	CSA C22.2 no. 4248.1	Industrial Control Equipment
	Designed according to	Contrôle de Conformité de Qualité (CCQ)	





Application standards

Application standards where the product can be used

Organization	Design	Standard	Description
	Designed for applications acc.	IEC/UL 62368-1	Audio/video, information and communication technology equipment - Part 1: Safety requirements

Compliances

The product complies with following Guide Lines

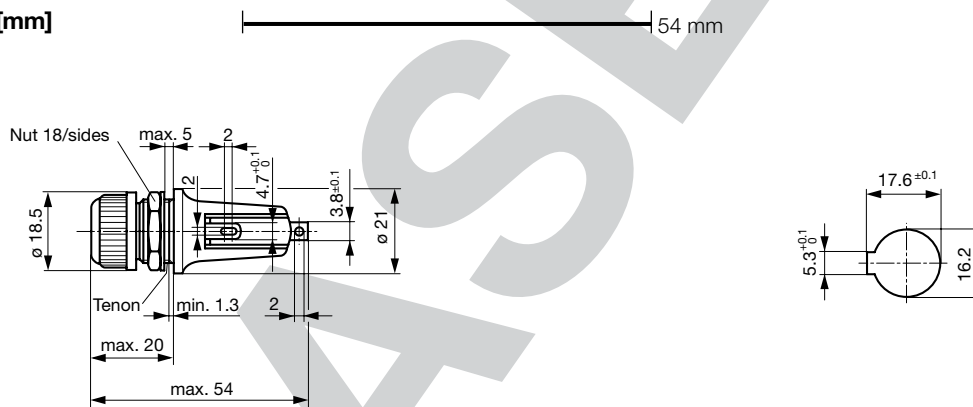

Identification	Details	Initiator	Description
		SCHURTER AG	The CE marking declares that the product complies with the applicable requirements laid down in the harmonisation of Community legislation on its affixing in accordance with EU Regulation 765/2008.
	UKCA declaration of conformity	SCHURTER AG	The UKCA marking declares that the product complies with the applicable requirements laid down in the British Amendment of Regulation (EC) 765/2008.
	RoHS	SCHURTER AG	Directive RoHS 2011/65/EU, Amendment (EU) 2015/863
	China RoHS	SCHURTER AG	The law SJ / T 11363-2006 (China RoHS) has been in force since 1 March 2007, It is similar to the EU directive RoHS.
	REACH	SCHURTER AG	On 1 June 2007, Regulation (EC) No 1907/2006 on the Registration, Evaluation, Authorization and Restriction of Chemicals 1 (abbreviated as "REACH") entered into force.

Dimension [mm]



Mounting holes

All Variants

Holder	Cap	Fuse-Link	Degree of Protection	   GAM T1 NNO	Reference	Order Number
●	Fingergrip	6.3 x 32mm	IP40	● ● ●	23312P	7092.2520
●	Fingergrip	6.3 x 32mm	IP67		23312ERJJP	7092.2630

Availability for all products can be searched real-time: <https://www.schurter.com/en/Stock-Check/Stock-Check-SCHURTER>

Packaging Unit

Bulk (100 pcs.)

X-ON Electronics

Largest Supplier of Electrical and Electronic Components

Click to view similar products for [Fuse Holder](#) category:

Click to view products by [Schurter](#) manufacturer:

Other Similar products are found below :

[570-290-741P40](#) [570-290-751P40](#) [020417G](#) [020418E](#) [6R30A1B](#) [F600A3B](#) [80910030](#) [8601.2020](#) [G15A2SPQ](#) [9-3557-GP REV A](#) [HDJ-B](#)
[R6J30A3S](#) [HFH-1](#) [RF30A2B](#) [RF30A3SP](#) [15600-08-10](#) [BK/FHN19G](#) [BK/HHM](#) [BK/HKP-CCHH](#) [BK/HKP-JJ](#) [BK/HTJ-LES-FUSE](#) [HMG-](#)
[241](#) [HTJ-LES-FUSE](#) [C4044-1](#) [2086-1](#) [2193](#) [2602](#) [2650](#) [178.000100](#) [FHN31G1](#) [T30A2B](#) [G4PB8](#) [2660](#) [2799](#) [CQ-209V](#) [HKP-CCHH](#)
[R6F30A2S](#) [341001A](#) [345621A](#) [CVRMCC](#) [4202](#) [4407](#) [4408](#) [4413](#) [4423](#) [4532](#) [4537](#) [TSD1404-12](#) [BK/FHN31G1](#) [BK/HC-5](#)