

Shock-Safe Fuseholder, 10.3 x 38 mm, Fingergrip



600 VAC · 4.5W/25A25A (UL/CSA)

See below:  
[Approvals and Compliances](#)

### Description

- Screw type fuse carrier

### References

Last order date: 30.09.2021

### Weblinks

[pdf data sheet](#), [html datasheet](#), [General Product Information](#), [Distributor-Stock-Check](#), [Detailed request for product](#), [Microsite](#)

### Technical Data

Fuse-Link	10.3 x 38 mm	Soldering Methods	Iron
Mounting	Panel mount, Front Side		<a href="#">Soldering Profile</a>
Terminal	Quick-Connect 6.3 x 0.8 mm	Contact Resistance	< mΩ at 100 mA
Rated Voltage	600 VAC	Panel Thickness	max 4 mm
Rated current	25 A (UL/CSA)		
Rated Power Acceptance IEC	4.5 W / 25 A @ Ta 23 °C		
Degree of Protection	IP40 / IP67		
Admissible Ambient Air Temp.	-40 °C to 85 °C		
Climatic Category	40/085/21 acc. to IEC 60068-1		
Material: Socket	Thermoset, black		
Unit Weight	48 g		
Storage Conditions	0 °C to 60 °C, max. 70% r.h.		
Product Marking	Type, Rated Voltage, Rated current		

### Approvals and Compliances



Detailed information on product approvals, code requirements, usage instructions and detailed test conditions can be looked up in [Details about Approvals](#)

SCHURTER products are designed for use in industrial environments. They have approvals from independent testing bodies according to national and international standards. Products with specific characteristics and requirements such as required in the automotive sector according to IATF 16949, medical technology according to ISO 13485 or in the aerospace industry can be offered exclusively with customer-specific, individual agreements by SCHURTER.

### Approvals



The approval mark is used by the testing authorities to certify compliance with the safety requirements placed on electronic products.

Approval Reference Type: 23530P

Approval Logo	Certificates	Certification Body	Description
	<a href="#">UL Approvals</a>	UL	UL File Number: E41738
	<a href="#">CSA Approvals</a>	CSA	CSA Certification Record: 23151
			

**Product standards**

Product standards that are referenced

Organization	Design	Standard	Description
	Designed according to	UL 4248-1	Industrial Control Equipment
	Designed according to	CSA C22.2 no. 4248.1	Industrial Control Equipment





**Application standards**

Application standards where the product can be used

Organization	Design	Standard	Description
	Designed for applications acc.	IEC/UL 62368-1	Audio/video, information and communication technology equipment - Part 1: Safety requirements

**Compliances**

The product complies with following Guide Lines

Identification	Details	Initiator	Description
		SCHURTER AG	The CE marking declares that the product complies with the applicable requirements laid down in the harmonisation of Community legislation on its affixing in accordance with EU Regulation 765/2008.
	UKCA declaration of conformity	SCHURTER AG	The UKCA marking declares that the product complies with the applicable requirements laid down in the British Amendment of Regulation (EC) 765/2008.
	RoHS	SCHURTER AG	Directive RoHS 2011/65/EU, Amendment (EU) 2015/863
	China RoHS	SCHURTER AG	The law SJ / T 11363-2006 (China RoHS) has been in force since 1 March 2007. It is similar to the EU directive RoHS.
	REACH	SCHURTER AG	On 1 June 2007, Regulation (EC) No 1907/2006 on the Registration, Evaluation, Authorization and Restriction of Chemicals 1 (abbreviated as "REACH") entered into force.

**Dimension [mm]**

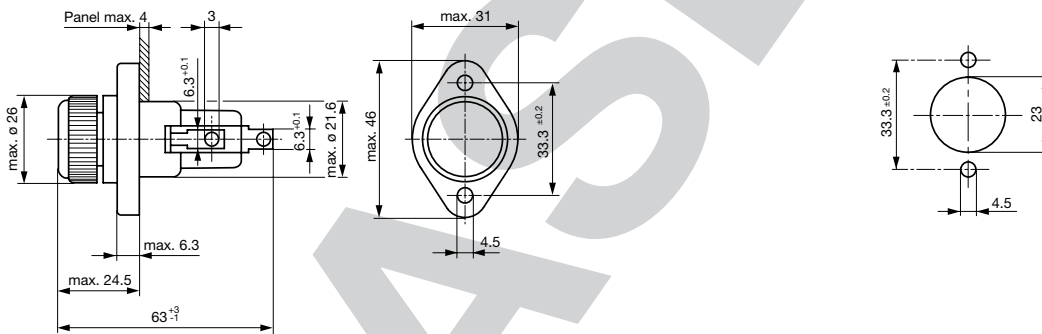

Mounting holes

**All Variants**

Holder	Cap	Degree of Protection		Reference	Order Number
●	Fingergrip	IP40	● ● ●	23530P	7093.2510
●	Fingergrip	IP67	● ● ●	23530JJP	7093.2540

Availability for all products can be searched real-time: <https://www.schurter.com/en/Stock-Check/Stock-Check-SCHURTER>

**Packaging Unit**

Bulk (10 pcs.)

## X-ON Electronics

Largest Supplier of Electrical and Electronic Components

*Click to view similar products for [Fuse Holder](#) category:*

*Click to view products by [Schurter](#) manufacturer:*

Other Similar products are found below :

[570-290-741P40](#) [570-290-751P40](#) [020417G](#) [020418E](#) [6R30A1B](#) [F600A3B](#) [80910030](#) [8601.2020](#) [G15A2SPQ](#) [9-3557-GP REV A](#) [HDJ-B](#)  
[R6J30A3S](#) [HFH-1](#) [RF30A2B](#) [RF30A3SP](#) [15600-08-10](#) [BK/FHN19G](#) [BK/HHM](#) [BK/HKP-CCHH](#) [BK/HKP-JJ](#) [BK/HTJ-LES-FUSE](#) [HMG-](#)  
[241](#) [HTJ-LES-FUSE](#) [C4044-1](#) [2086-1](#) [2193](#) [2602](#) [2650](#) [178.000100](#) [FHN31G1](#) [T30A2B](#) [G4PB8](#) [2660](#) [2799](#) [CQ-209V](#) [HKP-CCHH](#)  
[R6F30A2S](#) [341001A](#) [345621A](#) [CVRMCC](#) [4202](#) [4407](#) [4408](#) [4413](#) [4423](#) [4532](#) [4537](#) [TSD1404-12](#) [BK/FHN31G1](#) [BK/HC-5](#)