

IEC Appliance Inlet C14 with Filter, Circuit Breaker TA35 (recessed)

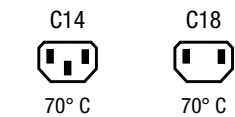

See below:
[Approvals and Compliances](#)

Description

- Panel mount :
 Screw-on or snap-in mounting front side
- 3 Functions :
 Appliance Inlet protection class I or II , Circuit breaker type TA35 2-pole
 , Line filter in standard and medical version
- Quick connect terminals 6.3 x 0.8 mm

Unique Selling Proposition

- IP67 protection
- Recessed rocker switch
- Various mounting options
- V-Lock cord retaining

Characteristics

- All single elements are already wired
- Circuit Breaker non-illuminated or illuminated
- Suitable for use in medical equipment according to IEC/UL 60601-1 (1 MOOP, 1 MOPP)
 For applications according IEC/UL 62368-1 we recommend variants with bleed resistor

Other versions on request

- Other rocker marking
- Medical Version (M80)
- Capacitance CX1
- Variants in white
- Filter version with high inductance

References

Alternative: version without line filter [DG11](#)

Weblinks

[pdf data sheet](#), [html datasheet](#), [General Product Information](#), [Approvals](#), [Distributor-Stock-Check](#), [Accessories](#), [Detailed request for product](#)

Technical Data

Ratings IEC	1 - 10A @ Ta 40 °C / 250VAC; 50Hz
Ratings UL/CSA	1 - 15A @ Ta 40 °C / 250VAC; 60Hz
Leakage Current	standard < 0.5mA (250V / 60Hz) medical < 5 µA (250 V / 60 Hz)
Dielectric Strength	> 1.7kVDC between L-N > 2.7kVDC between L/N-PE Test voltage (2 sec)
Allowable Operation Temperature	-25 °C to 60 °C
Climatic Category	25/060/21 acc. to IEC 60068-1
IP-Protection	front side IP40 / IP65 / IP67 acc. to IEC 60529
Protection Class	Suitable for appliances with protection class I or II acc. to IEC 61140
Terminal	Quick connect terminals 6.3 x 0.8 mm
Panel Thickness S	Screw: max 8mm Mounting screw torque max 0.5Nm : S = 1.0/1.2/1.5/2.0/2.5/3.0 mm
Material: Housing	Thermoplastic, black, UL 94V-0

Appliance inlet/-outlet	C14 C18 acc. to IEC 60320-1 UL 498, CSA C22.2 no. 42 (for cold conditions) pin-temperature 70 °C, 10A, Protection Class I or II
Circuit Breakers	Acc. IEC/EN 60934, UL 1077, CSA 22.2 no. 235 2-pole rocker switch, illuminated or non-illuminated. Optional with undervoltage- or remote trip release Short circuit capacity Icn: 2000 A
Line Filter	Standard and Medical Version, IEC 60939, UL 60939-3, CSA C22.2 no. 8 Technical Details
MTBF	> 100'000h acc. to MIL-HB-217 F



Approvals and Compliances

Detailed information on product approvals, code requirements, usage instructions and detailed test conditions can be looked up in [Details about Approvals](#)

SCHURTER products are designed for use in industrial environments. They have approvals from independent testing bodies according to national and international standards. Products with specific characteristics and requirements such as required in the automotive sector according to IATF 16949, medical technology according to ISO 13485 or in the aerospace industry can be offered exclusively with customer-specific, individual agreements by SCHURTER.







Approvals

The approval mark is used by the testing authorities to certify compliance with the safety requirements placed on electronic products.
 Approval Reference Type: DG12

Approval Logo	Certificates	Certification Body	Description
	VDE Approvals	VDE	Certificate Number: 40049092
	UL Approvals	UL	UL File Number: E495089
	CQC Approvals	CQC	CQC Certificate Number: CQC19001233482



Product standards

Product standards that are referenced

Organization	Design	Standard	Description
	Designed according to	IEC 60320-1	Appliance couplers for household and similar general purposes
	Designed according to	IEC 60939	Passive filters for suppressing electromagnetic interference
	Designed according to	IEC 61058-1	Switches for appliances. Part 1. General requirements
	Designed according to	UL 498	Standard for Attachment Plugs and Receptacles
	Designed according to	UL 60939-3	Electromagnetic interference filters
	Designed according to	CSA C22.2 no. 42	General Use Receptacles, Attachment Plugs, and Similar Wiring Devices
	Designed according to	CSA C22.2 no. 8	Electromagnetic interference (EMI) filters







Application standards

Application standards where the product can be used

Organization	Design	Standard	Description
	Designed for applications acc.	IEC/UL 62368-1	Audio/video, information and communication technology equipment - Part 1: Safety requirements
	Designed for applications acc.	IEC 60601-1	Medical electrical equipment - Part 1: General requirements for basic safety and essential performance

Compliances

The product complies with following Guide Lines

Identification	Details	Initiator	Description
	CE declaration of conformity	SCHURTER AG	The CE marking declares that the product complies with the applicable requirements laid down in the harmonisation of Community legislation on its affixing in accordance with EU Regulation 765/2008.
	UKCA declaration of conformity	SCHURTER AG	The UKCA marking declares that the product complies with the applicable requirements laid down in the British Amendment of Regulation (EC) 765/2008.
	RoHS	SCHURTER AG	Directive RoHS 2011/65/EU, Amendment (EU) 2015/863
	China RoHS	SCHURTER AG	The law SJ / T 11363-2006 (China RoHS) has been in force since 1 March 2007. It is similar to the EU directive RoHS.
	REACH	SCHURTER AG	On 1 June 2007, Regulation (EC) No 1907/2006 on the Registration, Evaluation, Authorization and Restriction of Chemicals 1 (abbreviated as "REACH") entered into force.
		SCHURTER AG	V-Lock system are based on a matching plug-dose combination. The connector is equipped with a notch intended for use with the latching cordset. The cord latching system prevents against accidental removal of the cordset.
	Medical Equipment	SCHURTER AG	Suitable for use in medical equipment according to IEC/UL 60601-1 (1 MOOP, 1 MOPP)

Dimension [mm]
 Snap-in version IP40

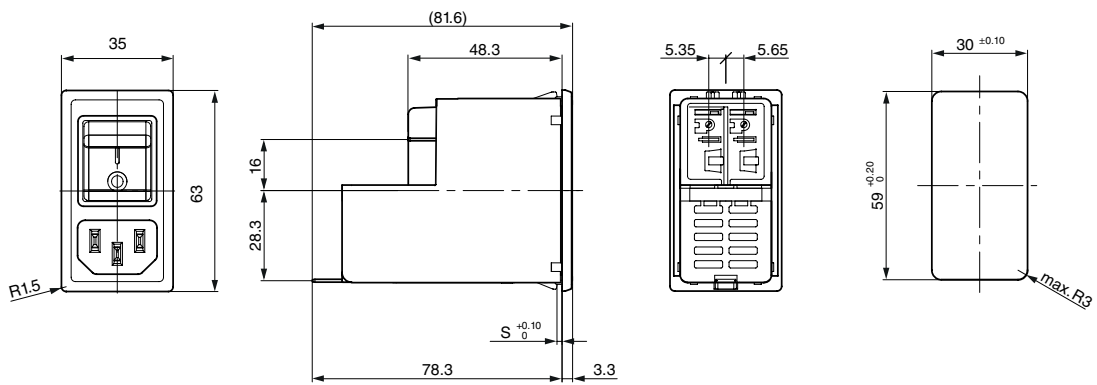

Screw-on A

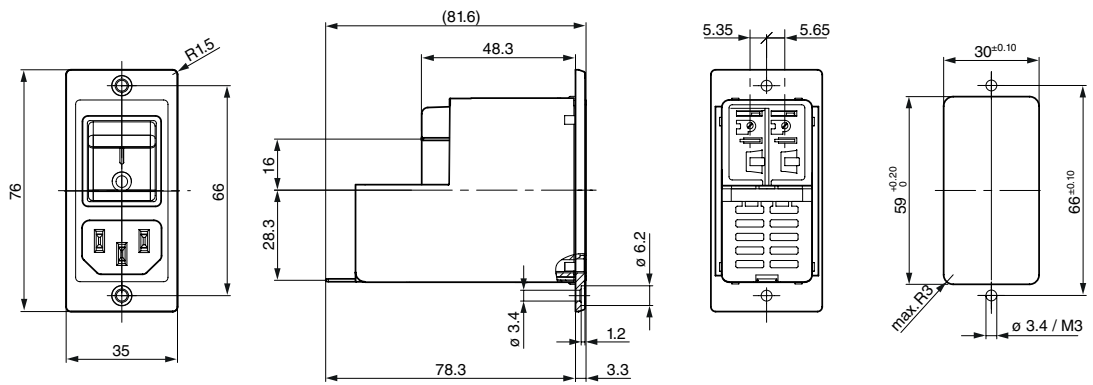

Screw-on B

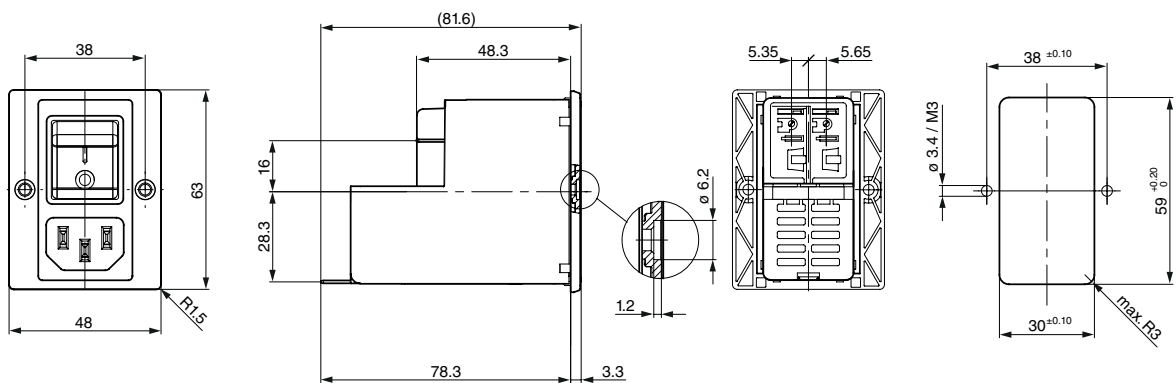

Screw-on with IP67

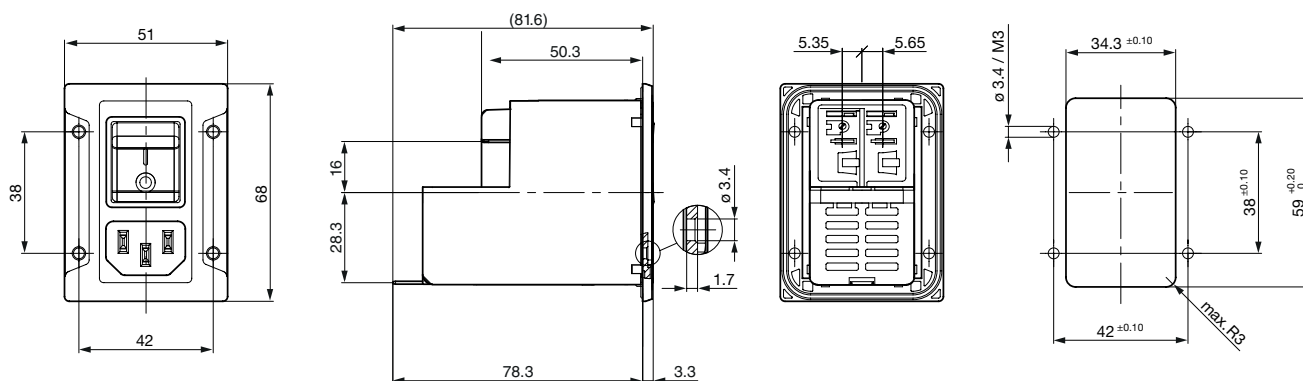

Technical Data of Filter-Components

Rated Current [A]	Filter-Type	Inductances L [mH]	Capacitance CX [nF]	Capacitance CY [nF]	R [MΩ]
1	Standard version	2 x 12	220	2.2	1
2	Standard version	2 x 5.2	220	2.2	1
3	Standard version	2 x 4	220	2.2	1
4	Standard version	2 x 2	220	2.2	1
6	Standard version	2 x 0.8	220	2.2	1
8	Standard version	2 x 0.6	220	2.2	1
10	Standard version	2 x 0.4	220	2.2	1
15	Standard version	2 x 0.1	220	2.2	1
10	Standard version with high inductance	2 x 0.65	220	2.2	1
15	Standard version with high inductance	2 x 0.2	220	2.2	1
10	Medical Version (M5)	2 x 0.4	220	-	1
15	Medical Version (M5)	2 x 0.1	220	-	1
10	Medical version (M5) with high inductance	2 x 0.65	220	-	1
15	Medical version (M5) with high inductance	2 x 0.2	220	-	1

Diagrams

Standard Version, medical Version M80

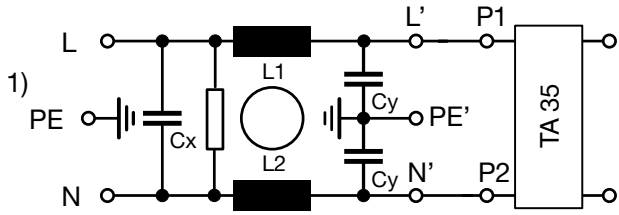

1) Line, 2) Load

Medical version M5, protection class I

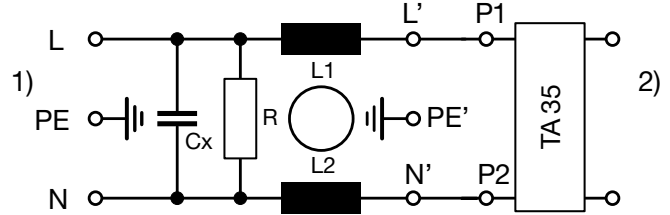

1) Line, 2) Load

Medicalversion (M5), Protection Class II

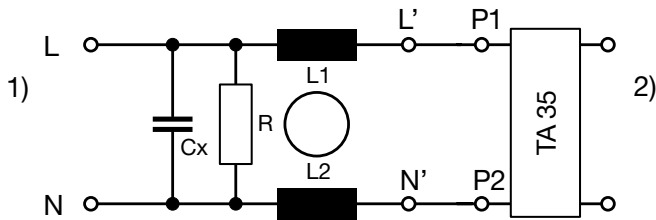

1) Line
 2) Load

Attenuation Loss

- - - 50Ω differential mode ____ 50Ω common mode

Standard version

1 A

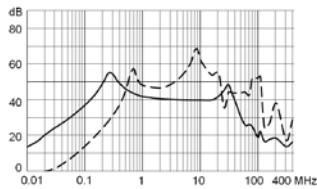

2 A

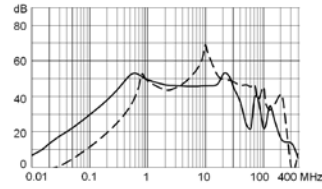

3 A

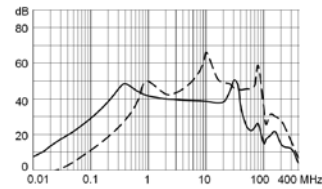

4 A

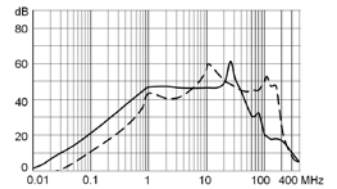

6 A

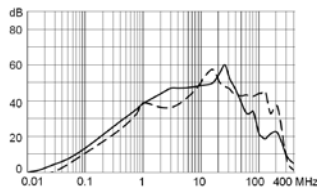

8 A

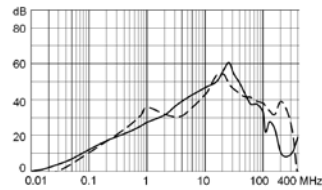

10 A

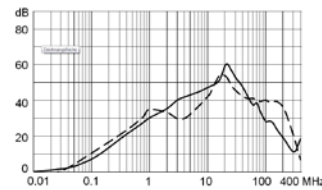

15 A

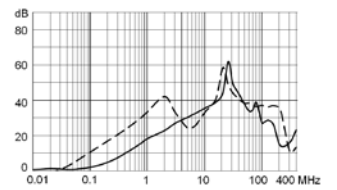

Medical version (M5)

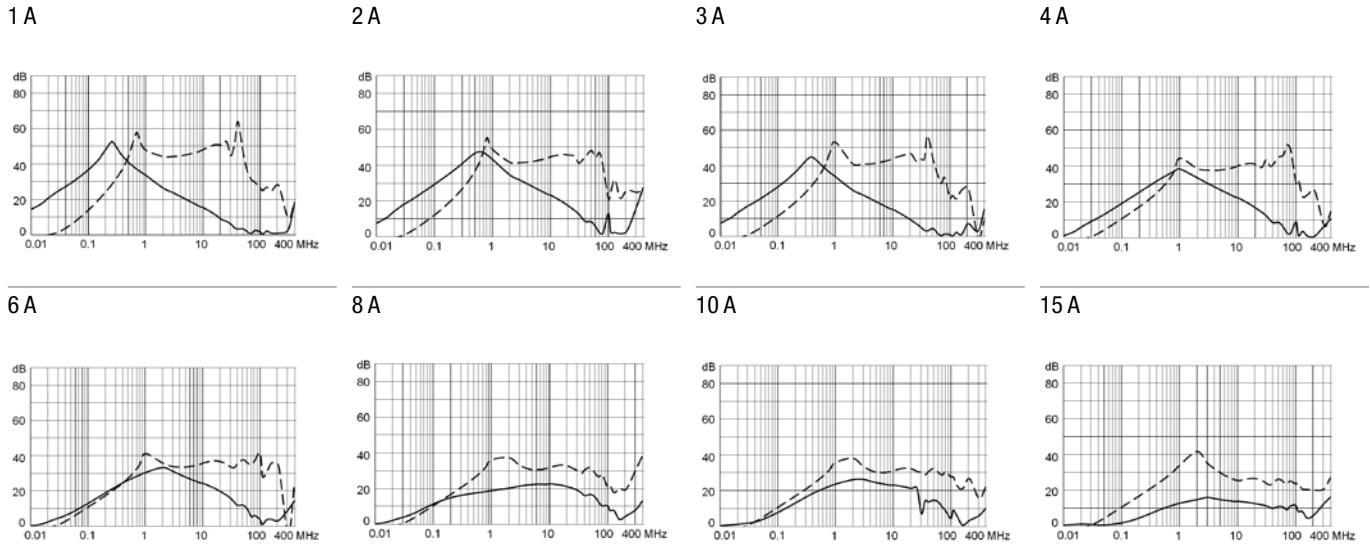

Effect of ambient temperature

Ambient Temperature [°C]	Correction factor
-30	0.76
-20	0.81
0	0.90
+23	1.00
+40	1.03
+50	1.04
+60	1.06

Time-Current-Curves

Tripping Characteristics $I_n < 3 A$

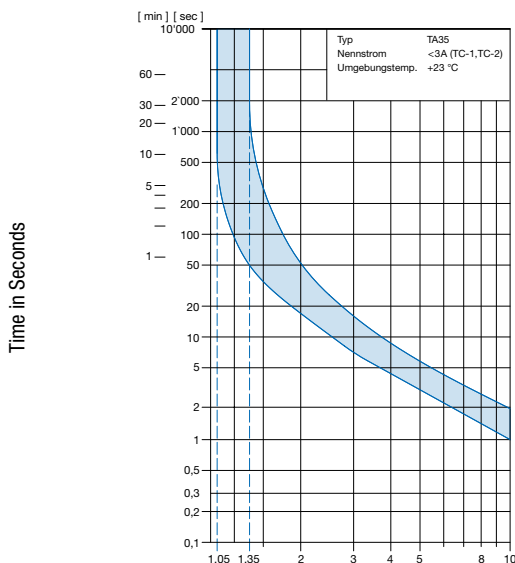

Multiple of Rated Current I_n

Reference Temperature +23°

Tripping Characteristics $I_n \geq 3 \dots \leq 15 A$

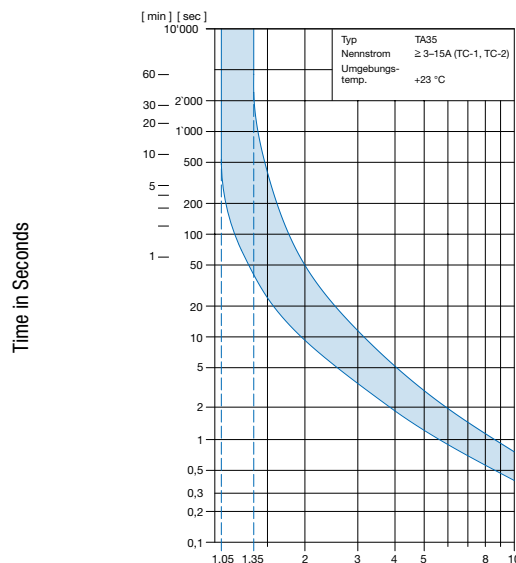

Multiple of Rated Current I_n

Reference Temperature +23°

Configuration Code

Type	Configuration Code TA35							
DG12	CBDWM100C0-000-C6135	X	X	X	X	X	X	0 0

Customer specific type

Color

- 0 Black
- 1 White

3)

Panel Mounting

- 00 Screw version A front mounting
- 01 Screw version B front mounting
- 10 Snap-in 1.0 mm
- 12 Snap-in 1.2 mm
- 15 Snap-in 1.5 mm
- 20 Snap-in 2.0 mm
- 25 Snap-in 2.5 mm
- 30 Snap-in 3.0 mm
- 88 Screw version front mounting (sealed towards housing, IP67)

1)

Terminal PE

- 0 Without (PCII)
- 1 QC 6.3x0.8 mm

Type of mains filter (inductance)

- 0 standard inductance
- 1 higher inductance

Type of mains filter (capacitor)

- 1 standard X2=100nF, Y2=2200pF
- 2 standard X2=220nF, Y2=2200pF
- 3 standard X1=47nF, Y1=2200pF
- 4 medical M5 X2=100nF
- 5 medical M5 X2=220nF
- 6 medical M5 X1=47nF
- 7 medical M80 X2=100nF, Y2=470pF
- 8 medical M80 X2=220nF, Y2=470pF
- 9 medical M80 X1=47nF, Y1=470pF

Type of mains filter (rated current)

- 1 1A
- 2 2A
- 3 3A
- 4 4A
- 5 6A
- 6 8A
- 7 10A
- 8 15A (UL), 10A (IEC), 10A (GB)

2)

Configuration Code TA35

See configuration code of TA35 rocker 2pole

2)

1)



Screw version A

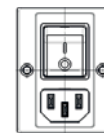

Screw version B

2)

The rated current of the line-filter must not be exceeded in the end application.

3)

Only on request (approvals pending)

Configuration Code

Type	Configuration Code TA35						
DG12	CBDWM100C0-000-C6135	X	X	X	X	X	X

Customer specific type

Color

- 0 Black
- 1 White

3)

Panel Mounting

- 00 Screw version A front mounting
- 01 Screw version B front mounting
- 10 Snap-in 1.0 mm
- 12 Snap-in 1.2 mm
- 15 Snap-in 1.5 mm
- 20 Snap-in 2.0 mm
- 25 Snap-in 2.5 mm
- 30 Snap-in 3.0 mm
- 88 Screw version front mounting (sealed towards housing, IP67)

1)

Terminal PE

- 0 Without (PCII)
- 1 QC 6.3x0.8 mm

Type of mains filter (inductance)

- 0 standard inductance
- 1 higher inductance

Type of mains filter (capacitor)

- 1 standard X2=100nF, Y2=2200pF
- 2 standard X2=220nF, Y2=2200pF
- 3 standard X1=47nF, Y1=2200pF
- 4 medical M5 X2=100nF
- 5 medical M5 X2=220nF
- 6 medical M5 X1=47nF
- 7 medical M80 X2=100nF, Y2=470pF
- 8 medical M80 X2=220nF, Y2=470pF
- 9 medical M80 X1=47nF, Y1=470pF

Type of mains filter (rated current)

- 1 1A
- 2 2A
- 3 3A
- 4 4A
- 5 6A
- 6 8A
- 7 10A
- 8 15A (UL), 10A (IEC), 10A (GB)

2)

Configuration Code TA35

See configuration code of TA35 rocker 2pole

2)

1)

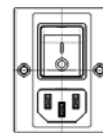

Screw version A

Screw version B

2)

The rated current of the line-filter must not be exceeded in the end application.

3)

Only on request (approvals pending)

ORDER CODE

Table 1 Selection for type TA35

Order example

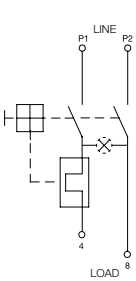
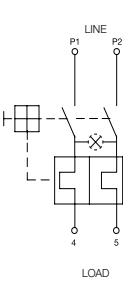
Number of switched poles Number of protected poles		2-pole	
		1	2
			
Switch	without illumination	CBT	CBD
Switch	illuminated 240 V 120 V	C12 C14	C32 C34

Other versions on request

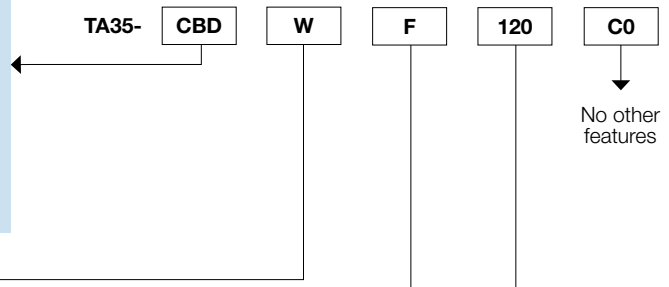









Colours

	Switch front	Rocker	
		non-illuminated	illuminated
W	black	white	–
B	black	black	–
3	black	–	red transparent
4	black	–	green transparent
6	black	–	orange transparent

Other colours on request

Rocker legend

	Surface	Illustration		Colour of print
				
F	embossed	–		
H	printed			white
K	printed			black
L	printed	–		white
M	printed	–		black

Other legends on request

Position of the rocker legend e.g. I / O

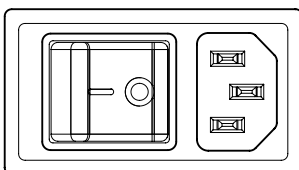

Rated current I_n (A)

I_n	Code	I_n	Code
1,0	J10	8,0	080
2,0	J20	10,0	100
4,0	040	12,0	120*
5,0	050	15,0	150*
6,0	060		

Other rated currents on request *) UL / CSA only

ORDER CODE

Table 1 Selection for type TA35

Order example

Number of switched poles Number of protected poles		2-pole	
		1	2
Switch	without illumination	CBT	CBD
Switch	illuminated 240 V 120 V	C12 C14	C32 C34

Other versions on request

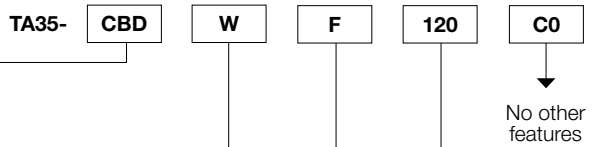

Colours

	Switch front	Rocker	
		non-illuminated	illuminated
W	black	white	–
B	black	black	–
3	black	–	red transparent
4	black	–	green transparent
6	black	–	orange transparent

Other colours on request

Rocker legend

	Surface	Illustration	Colour of print
F	embossed		
H	printed		white
K	printed		black
L	printed		white
M	printed		black

Other legends on request

Position of the rocker legend e.g. I / O

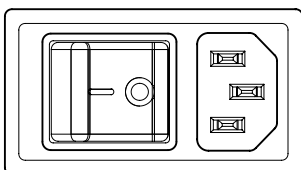

Rated current I_n (A)

I_n	Code	I_n	Code
1,0	J10	8,0	080
2,0	J20	10,0	100
4,0	040	12,0	120*
5,0	050	15,0	150*
6,0	060		

Other rated currents on request *) UL / CSA only

Variants

Circuit Breaker			Filter		Connector			Order Number	
Rated Current [A]	Rocker colour	Illumination	Rated Current [A]	Filter Type	Protection Class	Color	Mounting		IP-Protection
1	black	non-illuminated	1	Standard version	I	black	Screw-on A	IP40	3-108-854
10	white	non-illuminated	10	Standard version	I	black	Screw-on A	IP40	3-109-572
10	white	non-illuminated	10	Standard version	I	black	Snap-in 1.5	IP40	3-109-575
10	white	non-illuminated	10	Standard version	I	black	Screw-on B	IP40	3-109-698
10	white	non-illuminated	10	Standard version	I	black	Screw IP67	IP67	3-118-974
15	white	non-illuminated	15	Standard version	I	black	Screw-on A	IP40	3-109-573
2	white	non-illuminated	2	Standard version	I	black	Screw-on A	IP40	3-109-557
3	white	non-illuminated	3	Standard version	I	black	Screw-on A	IP40	3-109-558
4	black	non-illuminated	4	Standard version	I	black	Screw-on A	IP40	3-109-559
6	white	non-illuminated	6	Standard version	I	black	Screw-on A	IP40	3-109-560
8	white	non-illuminated	8	Standard version	I	black	Screw-on A	IP40	3-109-561
10	white	non-illuminated	10	Standard version with high inductance	I	black	Screw-on A	IP40	3-109-602
15	white	non-illuminated	15	Standard version with high inductance	I	black	Screw-on A	IP40	3-109-603
10	white	non-illuminated	10	Medical Version (M5)	I	black	Screw-on A	IP40	3-108-465
10	white	non-illuminated	10	Medical Version (M5)	I	black	Screw-on B	IP40	3-118-982
15	white	non-illuminated	15	Medical Version (M5)	I	black	Screw-on A	IP40	3-109-588
10	white	non-illuminated	10	Medical version (M5) with high inductance	I	black	Screw-on A	IP40	3-109-606
15	white	non-illuminated	15	Medical version (M5) with high inductance	I	black	Screw-on A	IP40	3-109-607

Most Popular.

Availability for all products can be searched real-time: <https://www.schurter.com/en/Stock-Check/Stock-Check-SCHURTER>

Packaging unit

10 Pcs

Accessories

Description



RC320
 Rear Cover for Power Entry Module

Mating Outlets/Connectors

Category / Description

[Appliance Outlet Overview complete](#)



4787, Mounting: Screw-on mounting, Appliance Outlet: IEC Solder terminals, 10 A, Suitable for appliances with protection class I	4787
4788, Mounting: Snap-in version, Appliance Outlet: IEC Solder / Quick Connect, 10 A, Suitable for appliances with protection class I	4788
IEC Appliance Outlet F or H, Screw-on Mounting, Front Side, Solder, PCB or Quick-connect Terminal	5091

[Connector Overview complete](#)



4782 Mounting: Power Cord, 3 x 1 mm ² / 3 x 18 AWG, Cable, Connector: IEC C13	4782
4785 Mounting: Power Cord, 3 x 1 mm ² / 3 x 18 AWG, Cable, Connector: IEC C13	4785
4300-06 Mounting: Power Cord, 3 x 1 mm ² / 3 x 18 AWG, Cable, Connector: IEC C13	4300-06
4781 Mounting: Power Cord, Cable, Connector: IEC C15	4781
4784 Mounting: Power Cord, 3 x 1 mm ² / 3 x 18 AWG, Cable, Connector: IEC C15	4784

...

Mating Outlets/Connectors shuttered

[Connector Overview complete](#)



4783 Mounting: Power Cord, 3 x 1 mm ² / 3 x 18 AWG, Cable, Connector: IEC C13	4783
--	------

[Power Cord Overview complete](#)



VAC13KS, Overview, V-Lock cord retaining, diverse Connector IEC C13, diverse, black	VAC13KS
---	---------

X-ON Electronics

Largest Supplier of Electrical and Electronic Components

Click to view similar products for [AC Power Entry Modules](#) category:

Click to view products by [Schurter](#) manufacturer:

Other Similar products are found below :

[6167.0002](#) [6609100-2](#) [7-6609955-2](#) [FN361-6-06](#) [FN389-4-22](#) [FN9233S1-10-06](#) [FN9233S1-8-06](#) [FN9233S1B-8-06](#) [FN9233S1R-1-06](#)
[FN9233S1R-12-06](#) [FN9233SB-1-06](#) [FN9233SB-12-06](#) [FN9233SB-8-06](#) [FN9233SR-10-06](#) [FN9244B-15-06HI](#) [FN9244EB-3-06](#) [FN9244EB-8-06](#) [FN9244ER-15-06](#) [FN9244ER-8-06](#) [FN9244ES1-8-06](#) [FN9244ESB-8-06](#) [FN9244R-12-06](#) [FN9244S1-12-06](#) [FN9244S1R-3-06](#)
[FN9244SB-8-06](#) [FN9244SR-10-06](#) [FN9244SR-3-06](#) [FN9244SR-6-06](#) [FN9244U-3-06](#) [FN9244U-8-06](#) [PE00SSSXB](#) [Fuse-H-EUR-1](#)
[PM00XD000](#) [15EJMS8](#) [1-6609941-2](#) [200JM6-2](#) [CA121003-6](#) [SK-1015\(F1-5\)](#) [1-6609153-2](#) [FN323-1-05](#) [FN372-2-](#) [FN9233B-8-06](#)
[FN9233EB-1-06](#) [FN9233ES1R-10-06](#) [FN9233S-10-06](#) [FN9233S1B-10-06](#) [FN9233S1B-12-06](#) [FN9233S1B-6-06](#) [FN9233U-6-06](#) [FN9244-6-07](#)