

IEC Appliance Inlet C14 with Fuseholder 1- or 2-pole



Screw-on mounting
with fuseholder 1- or 2-pole
Sandwich/rear-side



Snap-in version
with fuseholder 1- or 2-pole
Sandwich/rear-side



Metal snaps Version, Detail view
IEC connector C14 with fuse holder 1- or 2-pole
Sandwich/rear-side



See below:
[Approvals and Compliances](#)

Description

- Panel mount :
Sandwich/rear-side
- 2 Functions :
Appliance Inlet Protection class I , with or without Fuseholder for fuse-links 5 x 20 mm on the rear-side 1- or 2-pole
- Meets the requirements of IEC 60335-1 for appliances in unattended use. This includes the enhanced requirements of glow wire tests acc. to IEC 60695-2-11 or -12 &-13.
- For PCB mounting
- Pick and place version

Characteristics

- PCB mount with snap-in or screw-on feet
Suitable for automatic PCB assembling
- All single elements are already wired
- Fuseholder on the inside of the equipment prevents accidental use of incorrect fuse-links by the user
- Blister tray as optional packaging variant
- Suitable for use in equipment according to IEC/UL 62368-1

Other versions on request

- Ground terminal with quick-connect terminal 6,3 x 0,8 mm
- Ground terminal with solder terminal
- For protection class II

Weblinks

[pdf data sheet](#), [html datasheet](#), [General Product Information](#), [Approvals](#), [Distributor-Stock-Check](#), [Accessories](#), [Detailed request for product](#)

Newly available variants corresponding to V-Lock mating cordset. The connector is equipped with a notch intended for use with the latching cordset. The cord latching system prevents against accidental removal of the cordset.

Technical Data

Ratings IEC	10A / 250VAC; 50Hz	Appliance inlet/-outlet	C14 acc. to IEC 60320-1, UL 498, CSA C22.2 no. 42 (for cold conditions) pin-temperature 70 °C, 10A, Protection Class I
Ratings UL/CSA	10A / 250VAC; 60Hz without fuseholder 16A (UL)	Fuseholder	1-/2-pole, Shocksafe category PC2 acc. to IEC 60127-6, for fuse-links 5 x 20mm
Dielectric Strength	> 3kVAC between L-N > 4kVAC between L/N-PE (1 min/50Hz)	Rated Power Acceptance @ Ta 23 °C	5 x 20: 3.15W (1 pole)/ 2.5W (2-pole) per pole
Allowable Operation Temperature	-25 °C to 70 °C	Power Acceptance @ Ta > 23°C	Admissible power acceptance at higher ambient temperature see derating curves
IP-Protection	front side IP40 acc. to IEC 60529		
Protection against electric shock	Suitable for appliances with protection class I acc. to IEC 61140		
Terminal	For PCB mounting		
Panel Thickness S	Screw: max 6mm Mounting screw torque max 0.3Nm Snap-in: 1.5/2/2.5/3 mm		
Material: Housing	Thermoplastic, black, UL 94V-0		

Approvals and Compliances



Detailed information on product approvals, code requirements, usage instructions and detailed test conditions can be looked up in [Details about Approvals](#)

SCHURTER products are designed for use in industrial environments. They have approvals from independent testing bodies according to national and international standards. Products with specific characteristics and requirements such as required in the automotive sector according to IATF 16949, medical technology according to ISO 13485 or in the aerospace industry can be offered exclusively with customer-specific, individual agreements by SCHURTER.

Approvals





The approval mark is used by the testing authorities to certify compliance with the safety requirements placed on electronic products.

Approval Reference Type: GSF1

Approval Logo	Certificates	Certification Body	Description
	VDE Approvals	VDE	Certificate Number: 40024857
	UL Approvals	UL	UL File Number: E93617, E96454
	CCC Approvals	CCC	CCC Certificate Number: 2006010204183182



Product standards

Product standards that are referenced

Organization	Design	Standard	Description
	Designed according to	IEC 60320-1	Appliance couplers for household and similar general purposes
	Designed according to	IEC 60127-6	Miniature fuses. Part 6. Fuse-holders for miniature fuse-links
	Designed according to	IEC 61058-1	Switches for appliances. Part 1. General requirements
	Designed according to	UL 498	Standard for Attachment Plugs and Receptacles
	Designed according to	CSA C22.2 no. 42	General Use Receptacles, Attachment Plugs, and Similar Wiring Devices







Application standards

Application standards where the product can be used

Organization	Design	Standard	Description
	Designed for applications acc.	IEC/UL 62368-1	Audio/video, information and communication technology equipment - Part 1: Safety requirements
	Designed for applications acc.	IEC 60335-1	Safety of electrical appliances for household and similar purposes. Meets the requirements for appliances in unattended use. This includes the enhanced requirements of glow wire tests acc. to IEC 60695-2-11 or -12 & -13.

Compliances

The product complies with following Guide Lines

Identification	Details	Initiator	Description
	CE declaration of conformity	SCHURTER AG	The CE marking declares that the product complies with the applicable requirements laid down in the harmonisation of Community legislation on its affixing in accordance with EU Regulation 765/2008.
	UKCA declaration of conformity	SCHURTER AG	The UKCA marking declares that the product complies with the applicable requirements laid down in the British Amendment of Regulation (EC) 765/2008.
	RoHS	SCHURTER AG	Directive RoHS 2011/65/EU, Amendment (EU) 2015/863
	China RoHS	SCHURTER AG	The law SJ / T 11363-2006 (China RoHS) has been in force since 1 March 2007. It is similar to the EU directive RoHS.
	REACH	SCHURTER AG	On 1 June 2007, Regulation (EC) No 1907/2006 on the Registration, Evaluation, Authorization and Restriction of Chemicals 1 (abbreviated as "REACH") entered into force.
		SCHURTER AG	V-Lock system are based on a matching plug-dose combination. The connector is equipped with a notch intended for use with the latching cordset. The cord latching system prevents against accidental removal of the cordset.
	White Paper Glow wire test	SCHURTER AG	Meets the requirements of IEC 60335-1 for appliances in unattended use. This includes the enhanced requirements of glow wire tests acc. to IEC 60695-2-11 or -12 & -13.

Dimensions [mm]

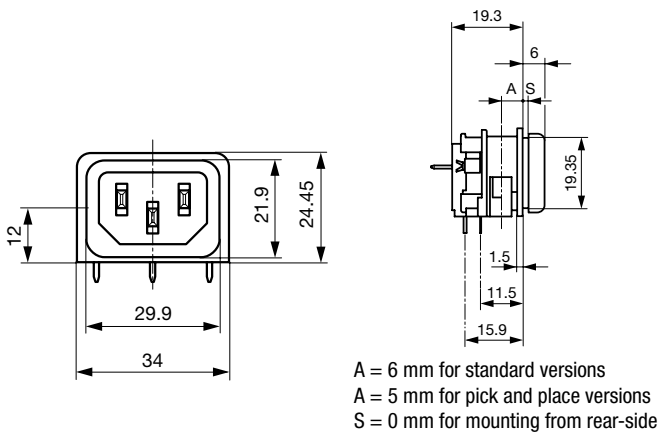

with insulation cover on rear side for version without fuseholder

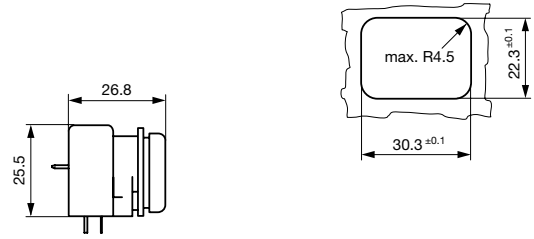

for mounting from rear-side

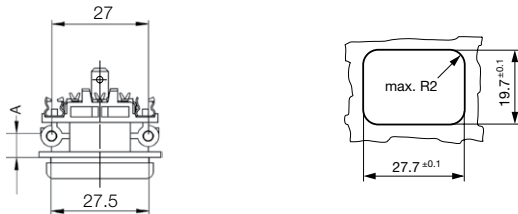

A = 6 mm for standard versions
 A = 5 mm for pick and place versions

for sandwich mounting

Drilling diagrams

without fuseholder

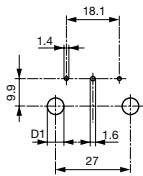

D1 for snap-in mounting = 6 ± 0.05
 D1 for self-tapping screw = 3.6 ± 0.1

with 1-pole fuseholder

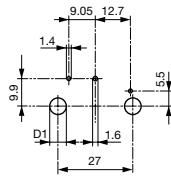

D1 for snap-in mounting = 6 ± 0.05
 D1 for self-tapping screw = 3.6 ± 0.1

with 2-pole fuseholder

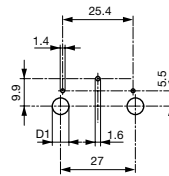

D1 for snap-in mounting = 6 ± 0.05
 D1 for self-tapping screw = 3.6 ± 0.1

Pick and Place versions without / with 1-pole or 2-pole fuseholder

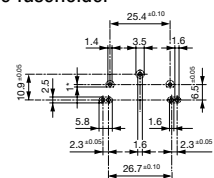

1* only for protection class II

Derating Curves

1-pole

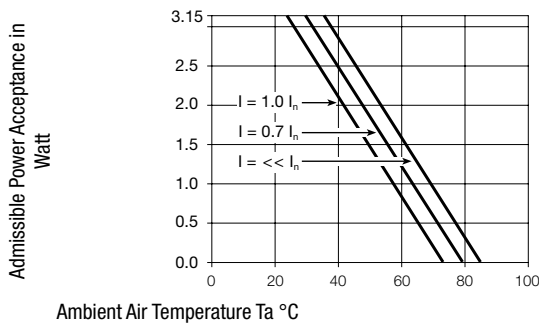

2-pole

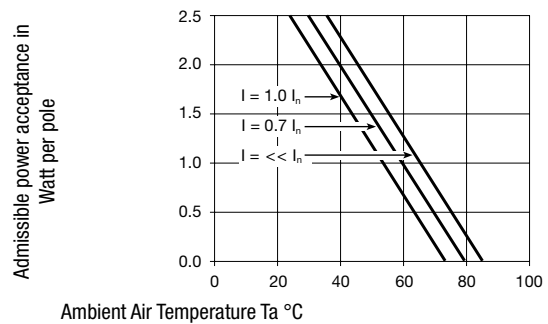

All Variants

Mounting side	Panel mounting	Panel Thickness s [mm]	Fuseholder	Ground terminal 4.8 x 0.8 mm	Ground terminal direction	Packaging	V-Lock	Order Number
Sandwich	Snap-in	1.5	-	●	straight	-		GSF1.0201.31
Sandwich	Snap-in	2	-	●	straight	-		GSF1.0201.41
Sandwich	Snap-in	2.5	-	●	straight	-		GSF1.0201.51
Sandwich	Snap-in	3	-	●	straight	-		GSF1.0201.61
Sandwich	Snap-in	1.5	-	●	angled to pin axis	-		GSF1.0202.31
Sandwich	Snap-in	2	-	●	angled to pin axis	-		GSF1.0202.41
Sandwich	Snap-in	2.5	-	●	angled to pin axis	-		GSF1.0202.51
Sandwich	Snap-in	3	-	●	angled to pin axis	-		GSF1.0202.61
Sandwich	Snap-in	1.5	1-pole	●	straight	-		GSF1.1201.31
Sandwich	Snap-in	2	1-pole	●	straight	-		GSF1.1201.41
Sandwich	Snap-in	2.5	1-pole	●	straight	-		GSF1.1201.51
Sandwich	Snap-in	3	1-pole	●	straight	-		GSF1.1201.61
Sandwich	Snap-in	1.5	1-pole	●	angled to pin axis	-		GSF1.1202.31
Sandwich	Snap-in	2	1-pole	●	angled to pin axis	-		GSF1.1202.41
Sandwich	Snap-in	2.5	1-pole	●	angled to pin axis	-		GSF1.1202.51
Sandwich	Snap-in	3	1-pole	●	angled to pin axis	-		GSF1.1202.61
Sandwich	Snap-in	1.5	2-pole	●	straight	-		GSF1.2201.31
Sandwich	Snap-in	2	2-pole	●	straight	-		GSF1.2201.41
Sandwich	Snap-in	2.5	2-pole	●	straight	-		GSF1.2201.51
Sandwich	Snap-in	3	2-pole	●	straight	-		GSF1.2201.61
Sandwich	Snap-in	1.5	2-pole	●	angled to pin axis	-		GSF1.2202.31
Sandwich	Snap-in	2	2-pole	●	angled to pin axis	-		GSF1.2202.41
Sandwich	Snap-in	2.5	2-pole	●	angled to pin axis	-		GSF1.2202.51
Sandwich	Screw	1.5	-	●	straight	-		GSF1.0001.31
Sandwich	Screw	2	-	●	straight	-		GSF1.0001.41
Sandwich	Screw	2.5	-	●	straight	-		GSF1.0001.51
Sandwich	Screw	3	-	●	straight	-		GSF1.0001.61
Sandwich	Screw	1.5	-	●	angled to pin axis	-		GSF1.0002.31
Sandwich	Screw	2	-	●	angled to pin axis	-		GSF1.0002.41
Sandwich	Screw	2.5	-	●	angled to pin axis	-		GSF1.0002.51
Sandwich	Screw	3	-	●	angled to pin axis	-		GSF1.0002.61
Sandwich	Screw	1.5	1-pole	●	straight	-		GSF1.1001.31
Sandwich	Screw	2	1-pole	●	straight	-		GSF1.1001.41
Sandwich	Screw	2.5	1-pole	●	straight	-		GSF1.1001.51
Sandwich	Screw	3	1-pole	●	straight	-		GSF1.1001.61
Sandwich	Screw	1.5	1-pole	●	angled to pin axis	-		GSF1.1002.31
Sandwich	Screw	2	1-pole	●	angled to pin axis	-		GSF1.1002.41
Sandwich	Screw	2.5	1-pole	●	angled to pin axis	-		GSF1.1002.51
Sandwich	Screw	3	1-pole	●	angled to pin axis	-		GSF1.1002.61
Sandwich	Screw	2.5	1-pole	●	straight	-		GSF1.1006.51
Sandwich	Screw	2.5	1-pole	●	straight	Blister tray		3-104-974
Sandwich	Screw	1.5	2-pole	●	straight	-		GSF1.2001.31
Sandwich	Screw	2	2-pole	●	straight	-		GSF1.2001.41
Sandwich	Screw	2.5	2-pole	●	straight	-		GSF1.2001.51
Sandwich	Screw	3	2-pole	●	straight	-		GSF1.2001.61
Sandwich	Screw	1.5	2-pole	●	angled to pin axis	-		GSF1.2002.31

Mounting side	Panel mounting	Panel Thickness s [mm]	Fuseholder	Ground terminal 4.8 x 0.8 mm	Ground terminal direction	Packaging	V-Lock	Order Number
Sandwich	Screw	2	2-pole	●	angled to pin axis	-		GSF1.2002.41
Sandwich	Screw	2.5	2-pole	●	angled to pin axis	-		GSF1.2002.51
Sandwich	Screw	3	2-pole	●	angled to pin axis	-		GSF1.2002.61
Rear Side	Snap-in	6	-	●	straight	-		GSF1.0201.01
Rear Side	Snap-in	6	-	●	angled to pin axis	-		GSF1.0202.01
Rear Side	Snap-in	6	1-pole	●	straight	-		GSF1.1201.01
Rear Side	Snap-in	6	1-pole	●	angled to pin axis	-		GSF1.1202.01
Rear Side	Snap-in	6	2-pole	●	straight	-		GSF1.2201.01
Rear Side	Snap-in	6	2-pole	●	angled to pin axis	-		GSF1.2202.01
Rear Side	Screw	6	-	●	straight	-		GSF1.0001.01
Rear Side	Screw	6	-	●	angled to pin axis	-		GSF1.0002.01
Rear Side	Screw	6	1-pole	●	straight	-		GSF1.1001.01
Rear Side	Screw	6	1-pole	●	angled to pin axis	-		GSF1.1002.01
Rear Side	Screw	6	2-pole	●	straight	-		GSF1.2001.01
Rear Side	Screw	6	2-pole	●	angled to pin axis	-		GSF1.2002.01
Rear Side	Metal snaps	6	-	●	angled to pin axis	Blister tray		GSF1.3402.01
Rear Side	Metal snaps	6	1-pole	●	angled to pin axis	Blister tray		GSF1.4402.01
Rear Side	Metal snaps	6	2-pole	●	angled to pin axis	Blister tray		GSF1.5402.01

Most Popular.

Availability for all products can be searched real-time: <https://www.schurter.com/en/Stock-Check/Stock-Check-SCHURTER>

Optional blister tray packaging 250 Pcs

Packaging unit 50 Pcs

Mating Outlets/Connectors

Category / Description

Appliance Outlet Overview complete



4787, Mounting: Screw-on mounting, Appliance Outlet: IEC Solder terminals, 10 A, Suitable for appliances with protection class I	4787
4788, Mounting: Snap-in version, Appliance Outlet: IEC Solder / Quick Connect, 10 A, Suitable for appliances with protection class I	4788
IEC Appliance Outlet F or H, Screw-on Mounting, Front Side, Solder, PCB or Quick-connect Terminal	5091

Connector Overview complete



4782 Mounting: Power Cord, 3 x 1 mm ² / 3 x 18 AWG, Cable, Connector: IEC C13	4782
4785 Mounting: Power Cord, 3 x 1 mm ² / 3 x 18 AWG, Cable, Connector: IEC C13	4785
4300-06 Mounting: Power Cord, 3 x 1 mm ² / 3 x 18 AWG, Cable, Connector: IEC C13	4300-06
4781 Mounting: Power Cord, Cable, Connector: IEC C15	4781
4784 Mounting: Power Cord, 3 x 1 mm ² / 3 x 18 AWG, Cable, Connector: IEC C15	4784

...

Mating Outlets/Connectors shuttered



[Connector Overview complete](#)

4783 Mounting: Power Cord, 3 x 1 mm² / 3 x 18 AWG, Cable, Connector: IEC C13

[4783](#)



[Power Cord Overview complete](#)

VAC13KS, Overview, V-Lock cord retaining, diverse Connector IEC C13, diverse, black

[VAC13KS](#)

VAC17KS, V-Lock cord retaining, diverse m, Connector IEC C17, diverse, black / grey / white

[VAC17KS](#)

X-ON Electronics

Largest Supplier of Electrical and Electronic Components

Click to view similar products for [AC Power Entry Modules](#) category:

Click to view products by [Schurter](#) manufacturer:

Other Similar products are found below :

[6167.0002](#) [6609100-2](#) [7-6609955-2](#) [FN361-6-06](#) [FN389-4-22](#) [FN9233S1-10-06](#) [FN9233S1-8-06](#) [FN9233S1B-8-06](#) [FN9233S1R-1-06](#)
[FN9233S1R-12-06](#) [FN9233SB-1-06](#) [FN9233SB-12-06](#) [FN9233SB-8-06](#) [FN9233SR-10-06](#) [FN9244B-15-06HI](#) [FN9244EB-3-06](#) [FN9244EB-8-06](#) [FN9244ER-15-06](#) [FN9244ER-8-06](#) [FN9244ES1-8-06](#) [FN9244ESB-8-06](#) [FN9244R-12-06](#) [FN9244S1-12-06](#) [FN9244S1R-3-06](#)
[FN9244SB-8-06](#) [FN9244SR-10-06](#) [FN9244SR-3-06](#) [FN9244SR-6-06](#) [FN9244U-3-06](#) [FN9244U-8-06](#) [PE00SSSXB](#) [Fuse-H-EUR-1](#)
[PM00XD000](#) [15EJMS8](#) [1-6609941-2](#) [200JM6-2](#) [CA121003-6](#) [SK-1015\(F1-5\)](#) [1-6609153-2](#) [FN323-1-05](#) [FN372-2-](#) [FN9233B-8-06](#)
[FN9233EB-1-06](#) [FN9233ES1R-10-06](#) [FN9233S-10-06](#) [FN9233S1B-10-06](#) [FN9233S1B-12-06](#) [FN9233S1B-6-06](#) [FN9233U-6-06](#) [FN9244-6-07](#)