

Description

The ASHxxCU are designed to protect voltage sensitive components from ESD and transient voltage events. Excellent clamping capability, low leakage, and fast response time. The ASHxxCU are suited for use in cellular phones, portable device, digital cameras, power supplies and many other portable applications.



Mechanical Characteristics

- ◆ SOD323
- ◆ ROHS/ Compliant
- ◆ Halogen free
- ◆ Molding compound flammability rating: UL 94V-0
- ◆ Marking: Part number
- ◆ Packing: Tape and Reel per EIA 481

Features

- ◆ IEC 61000-4-2 (ESD)
 - ±30kV Contact Discharge
 - ±30kV Air Discharge
- ◆ 350W peak pulse power (tp=8/20us)
- ◆ IEC 61000-4-4 EFT Protection
 - 40A (5/50ns)
- ◆ Halogen free and RoHS compliant
- ◆ Protects one directional I/O line
- ◆ Transient protection for high-speed data lines
- ◆ Low clamping current
- ◆ Low leakage current
- ◆ AEC-Q101 qualified

Applications

- ◆ Industrial and Serve Robots
- ◆ Laptops and Desktops
- ◆ TV and Monitors
- ◆ Wearables
- ◆ Handheld-wireless Systems

Dimensions and Pin Configuration

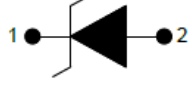
Pin	Name	Description	Outline	Circuit Diagram
1	IO	Connect to IO		
2	GND	Connect to GND		

Ordering Information

Part Number	Package	Material	Packing	Quantity per reel	Flammability Rating	Reel Size		
ASHxxCU	SOD323	Halogen free	Tape & Reel	3,000 PCS	UL 94V-0	7 inches		
Marking for the ASHxxCU series								
V _{RWM}	3.3V	5V	7V	12V	15V	18V	24V	36V
Marking	03W	D05	07W	12W	15W	18W	24W	36W

Absolute Maximum Ratings (T_A=25°C unless otherwise specified)

Parameters	Symbol	Min.	Max.	Unit
Peak pulse power (tp=8/20us)@25°C	P _{pk}	-	350	W
ESD (IEC61000-4-2 air discharge) @25°C	V _{ESD}	-	±30	kV
ESD (IEC61000-4-2 contact discharge) @25°C	V _{ESD}	-	±30	kV
Junction temperature	T _J	-	125	°C
Operating temperature	T _{OP}	-40	125	°C
Storage temperature	T _{STG}	-55	150	°C
Lead temperature	T _L	-	260	°C

Electrical Characteristics ($T_A=25^\circ\text{C}$ unless otherwise specified)

Part Number	V_{RWM} (max.)	V_{BR} (min.)	$V_{CL@I=1A}$ (max.)	I_{PP} (max.)	$V_{CL@I=I_{PP}}$ (max.)	I_R (max.)	C_J (typ.)
	(V)	(V)	(V)	(A)	(V)	(μA)	(pF)
ASH03CU	3.3	4.0	8	24	19	1.0	300
ASH05CU	5.0	6.0	9	20	20	1.0	300
ASH07CU	7.0	7.5	10	15	23	1.0	200
ASH12CU	12.0	13.3	19	12	33	1.0	150
ASH15CU	15.0	16.5	24	9	50	1.0	120
ASH18CU	18.0	19.0	30	8	55	1.0	100
ASH24CU	24.0	26.0	38	6	60	1.0	80
ASH36CU	36.0	38.0	55	4	70	1.0	50

Typical Performance Characteristics ($T_A=25^\circ\text{C}$ unless otherwise Specified)

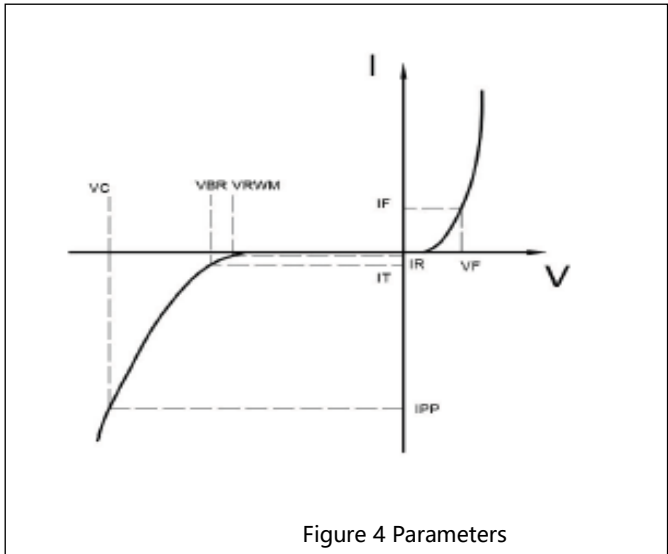
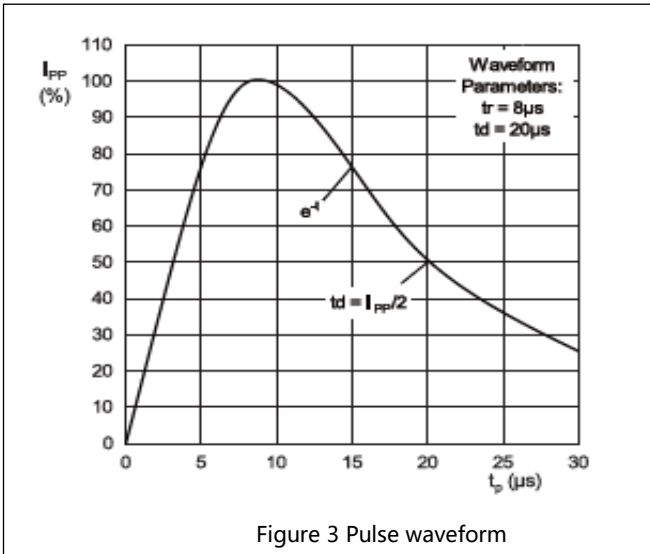
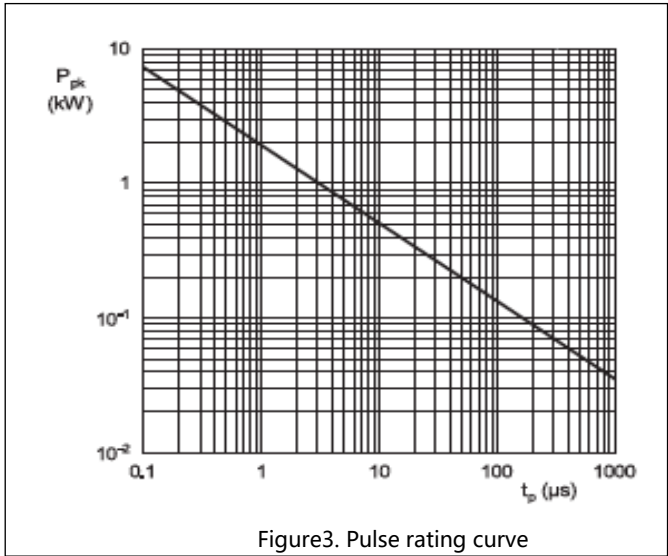
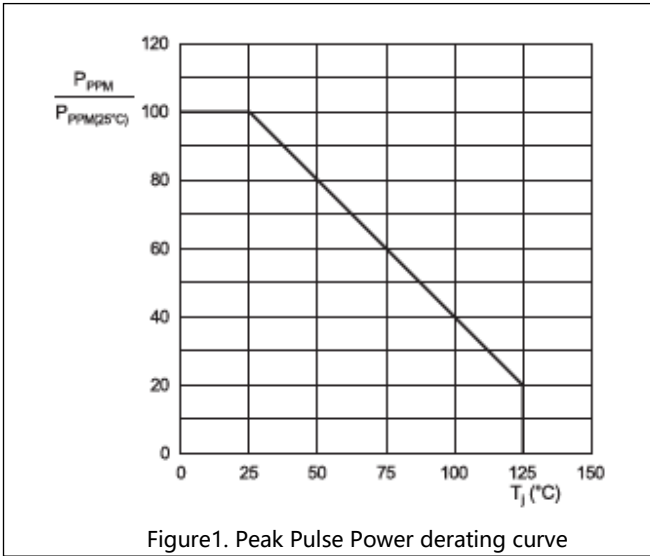

Applications Information

Typical Internet 1G Interface Application

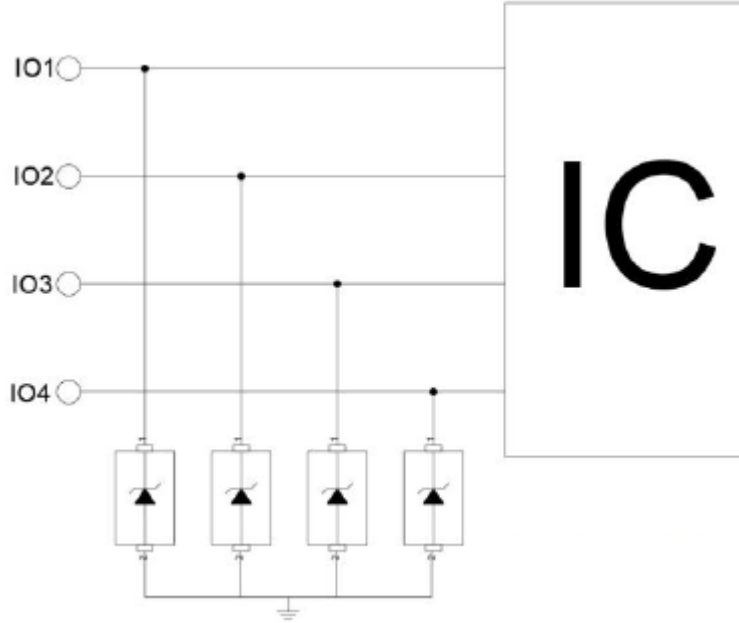

Package Outline Drawing

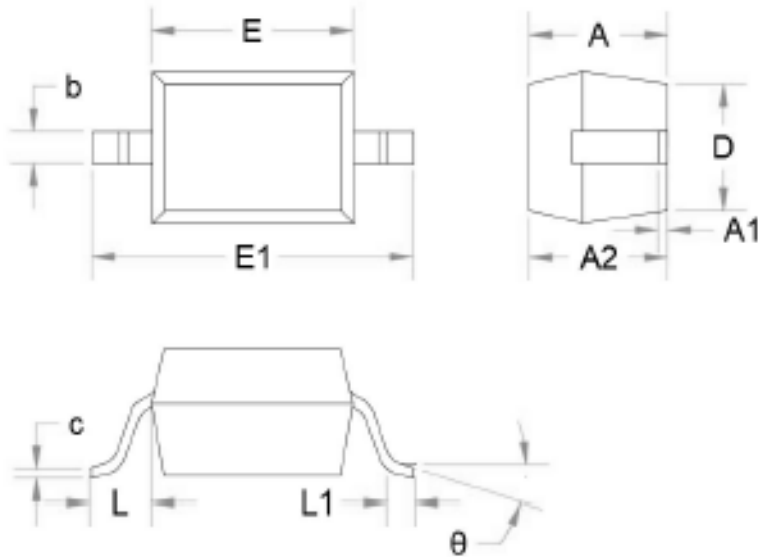

Units in millimeters

Symbol	Dimensions in Millimeters		Dimensions in Inches	
	Min.	Max.	Min.	Max.
A		1.0000		0.039
A1	0.000	0.100	0.000	0.004
A2	0.800	0.950	0.031	0.037
b	0.250	0.350	0.010	0.014
C	0.080	0.150	0.003	0.006
D	1.200	1.400	0.047	0.055
E	1.600	1.800	0.063	0.071
E1	2.400	2.750	0.094	0.108
L	0.475REF		0.019REF	
L1	0.250	0.400	0.010	0.016
θ	0	8	0	8

Recommended Land Pattern

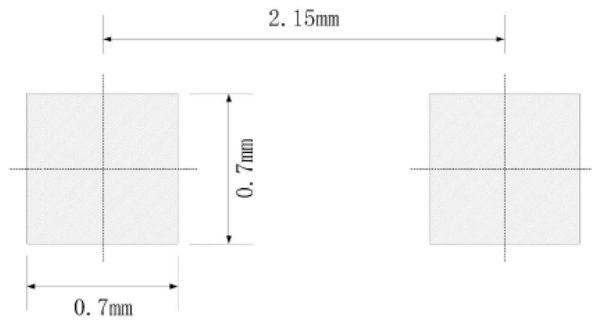

Note:

1. Controlling dimension: in millimeters
2. General tolerance: $\pm 0.05\text{mm}$
3. The pad layout is for reference only

Revision history of Specification

Version	Change Items	Effective Date
1.0	Initial Release	13-Aug-2021

X-ON Electronics

Largest Supplier of Electrical and Electronic Components

Click to view similar products for [ESD Suppressors / TVS Diodes](#) category:

Click to view products by [SCME](#) manufacturer:

Other Similar products are found below :

[60KS200C](#) [D18V0L1B2LP-7B](#) [D5V0F4U5P5-7](#) [NTE4902](#) [P4KE27CA](#) [P6KE11CA](#) [P6KE8.2A](#) [SA60CA](#) [SA64CA](#) [SMBJ12CATR](#)
[SMBJ33CATR](#) [SMBJ6.5A](#) [SMBJ8.0A](#) [ESD101-B1-02ELS](#) [E6327](#) [ESD112-B1-02EL](#) [E6327](#) [ESD7451N2T5G](#) [19180-510](#) [CPDT-5V0USP-](#)
[HF](#) [3.0SMCJ33CA-F](#) [3.0SMCJ36A-F](#) [HSPC16701B02TP](#) [JANTX1N6126A](#) [D3V3Q1B2DLP3-7](#) [D55V0M1B2WS-7](#) [SCM1293A-04SO](#)
[ESD200-B1-CSP0201](#) [E6327](#) [SM12-7](#) [CEN955](#) [W/DATA](#) [VESD12A1A-HD1-GS08](#) [CPDQC5V0-HF](#) [D1213A-01LP4-7B](#) [ESD101-B1-02EL](#)
[E6327](#) [AOZ8808DI-03](#) [5KP15A](#) [5KP48A](#) [5KP90A](#) [ESD3V3D7-TP](#) [15KPA36A-LF](#) [P4KE56CA](#) [P4KE68A](#) [P4KE91CATR](#) [P6KE120A](#)
[P6KE13CA](#) [P6KE43CA](#) [P6KE6.8CA](#) [P6KE8.2](#) [P6SMBJ20CA](#) [JANTX1N6072A](#) [SR2835ESKG](#) [SA90CA](#)