

Description

The ASLxxCB series low capacitance transient voltage suppressor arrays, designed to protect applications such as portable electronics and SMART phones. This series is available in bidirectional configurations and is rated at 350 Watts for an 8/20 μ s waveshape. This series offers a low capacitance and low leakage current in a miniature SOD323 package.



Mechanical Characteristics

- ◆ SOD323
- ◆ ROHS/ Compliant
- ◆ Halogen free
- ◆ Molding compound flammability rating: UL 94V-0
- ◆ Marking: Part number
- ◆ Packing: Tape and Reel per EIA 481

Features

- ◆ IEC 61000-4-2 (ESD)
 - \pm 30kV Contact Discharge
 - \pm 30kV Air Discharge
- ◆ 300W Peak pulse Power (8/20us)
- ◆ IEC 61000-4-4 EFT Protection
 - 40A(5/50ns)
- ◆ Halogen free and RoHS compliant
- ◆ Protection one directional I/O line
- ◆ Transient protection for high-speed data lines
- ◆ Low clamping voltage
- ◆ Low leakage current
- ◆ AEC-Q101 qualified

Application

- ◆ Cell Phone Handsets and Accessories
- ◆ Microprocessor based equipment
- ◆ Personal Digital Assistants
- ◆ Notebooks / Desktops / Servers
- ◆ Portable Instrumentation
- ◆ Peripherals & Pagers

Dimensions and Pin Configuration

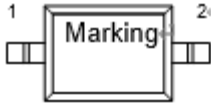
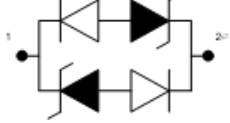
Pin	Name	Description	Outline	Circuit Diagram
1	IO	Connect to IO		
2	IO	Connect to IO		

Ordering Information

Part Number	Package	Material	Packing	Quantity per reel	Flammability Rating	Reel Size	
ASLxxCB	SOD323	Halogen free	Tape & Reel	3000PCS	UL 94V-0	7 inches	
Marking for the ASLxxCB series							
V_{RWM}	3.3V	5V	8V	12V	15V	24V	-
Marking	CC	AC	BC	DC	EC	HC	-

Absolute Maximum Ratings ($T_A=25^{\circ}\text{C}$ unless otherwise specified)

Parameters	Symbol	Min.	Max.	Unit
Peak pulse power ($t_p = 8/20\mu\text{s}$)@25°C	Ppk	-	300	W
ESD (IEC61000-4-2 air discharge) @25°C	V_{ESD}	-	± 30	kV
ESD (IEC61000-4-2 contact discharge) @25°C	V_{ESD}	-	± 30	kV
Junction temperature	T_J	-	125	°C
Operating temperature	T_{OP}	-40	125	°C
Storage temperature	T_{STG}	-55	150	°C
Lead temperature	T_L	-	260	°C

Electrical Characteristics ($T_A=25^{\circ}\text{C}$ unless otherwise specified)

Part Number	V_{RWM}	V_{BR}	$V_{CL@I=1A}$	I_{PP}	$V_{CL@I=I_{PP}}$	I_R	C_J
	(max.)	(min.)	(max.)	(max.)	(max.)	(max.)	(typ.)
	(V)	(V)	(V)	(A)	(V)	(μA)	(pF)
ASL03CB	3.3	4.0	8.5	17.0	20	1.0	0.8
ASL05CB	5.0	6.0	9.5	15.0	21	1.0	0.8
ASL08CB	8.0	8.5	12.0	12.0	25	1.0	0.8
ASL12CB	12.0	13.3	19.0	7.0	35	1.0	0.8
ASL15CB	15.0	16.5	24.0	5.0	45	1.0	0.8
ASL24CB	24.0	26.0	34.0	4.0	55	1.0	0.8

Typical Performance Characteristics ($T_A=25^\circ\text{C}$ unless otherwise Specified)

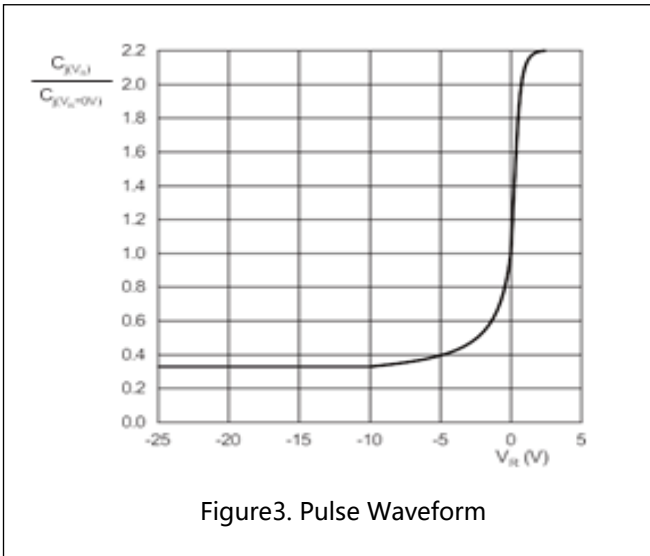
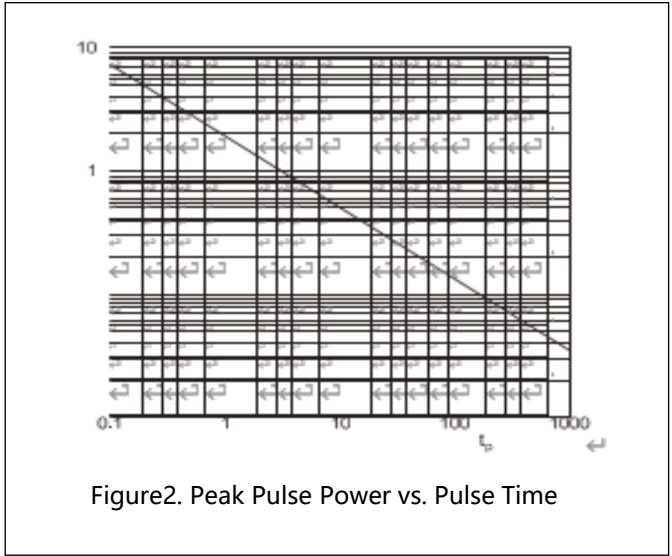
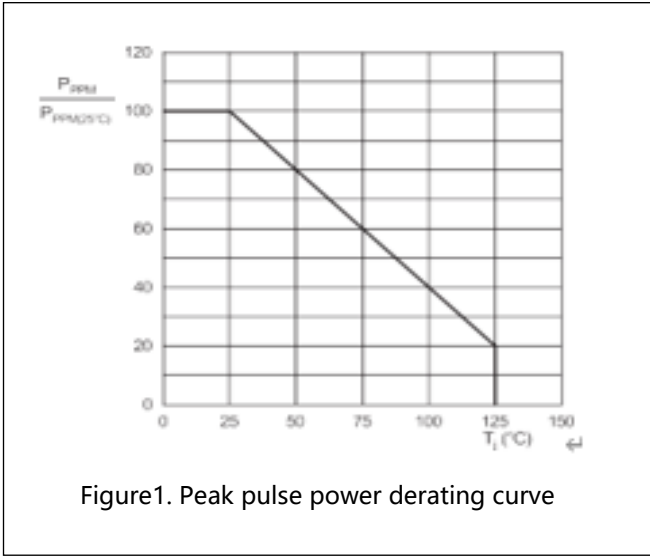

Applications Information

Typical Interface 1G Interface Application

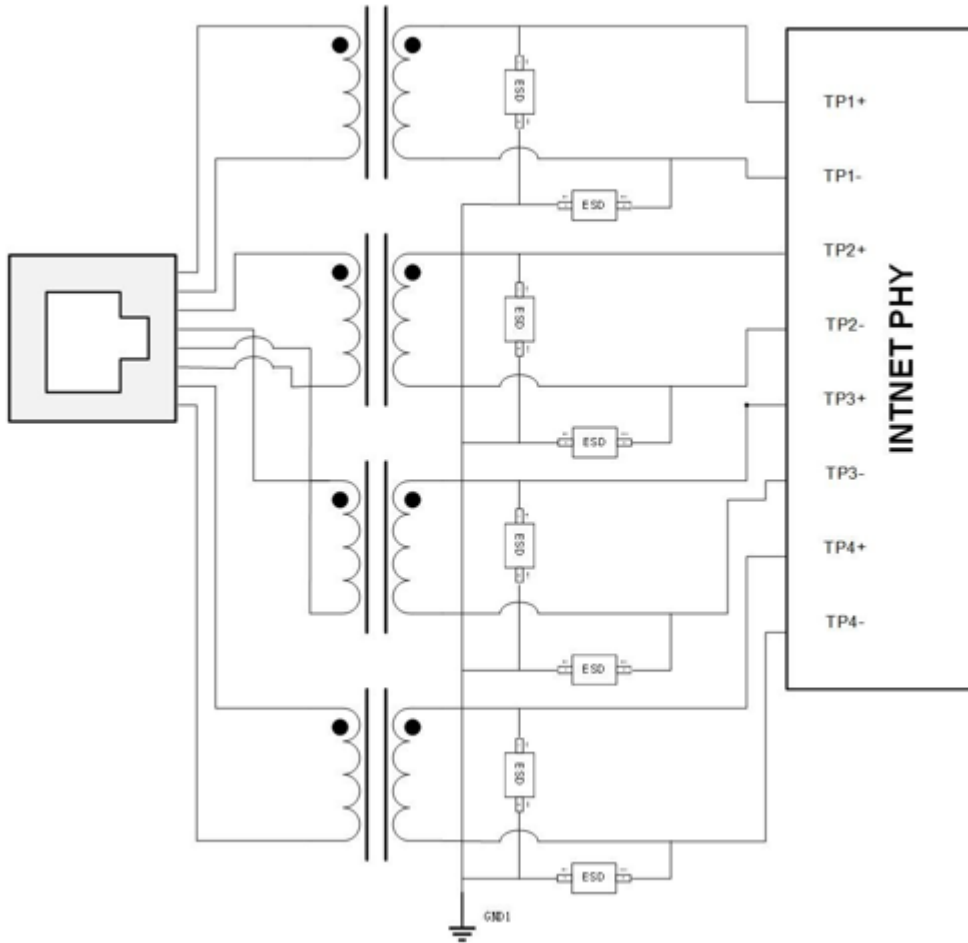

Package Outline Drawing

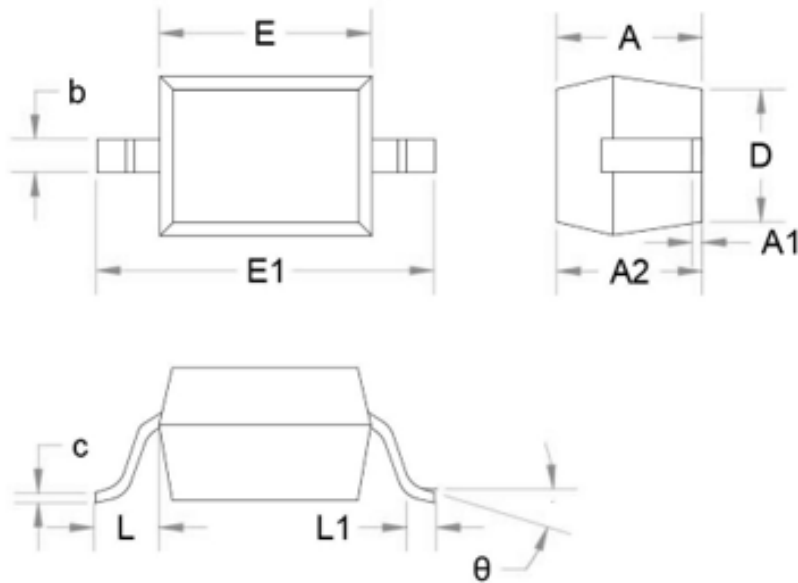

Units in millimeters

Symbol	Dimensions in Millimeters		Dimensions in Inches	
	Min.	Max.	Min.	Max.
A		1.000		0.039
A1	0.000	0.100	0.000	0.004
A2	0.800	0.900	0.031	0.035
b	0.250	0.350	0.010	0.014
C	0.080	0.150	0.003	0.006
D	1.200	1.400	0.047	0.055
E	1.600	1.800	0.063	0.071
E1	2.550	2.750	0.100	0.108
L	0.475REF		0.019REF	
L1	0.250	0.400	0.010	0.016
θ	0°	8°	0°	8°

Recommended Land Pattern

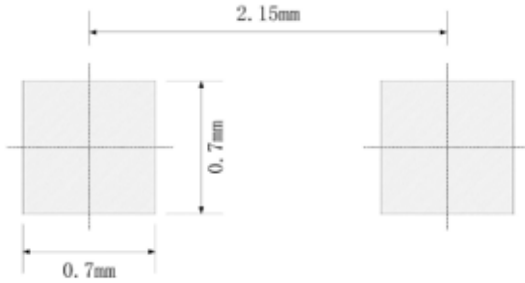

Note:

1. Controlling dimension: in millimeters
2. General tolerance: $\pm 0.05\text{mm}$
3. The pad layout is for reference only

Revision history of Specification

Version	Change Items	Effective Date
1.0	Initial Release	13-Aug-2021

X-ON Electronics

Largest Supplier of Electrical and Electronic Components

Click to view similar products for [ESD Suppressors / TVS Diodes](#) category:

Click to view products by [SCME](#) manufacturer:

Other Similar products are found below :

[60KS200C](#) [D18V0L1B2LP-7B](#) [D5V0F4U5P5-7](#) [NTE4902](#) [P4KE27CA](#) [P6KE11CA](#) [P6KE8.2A](#) [SA60CA](#) [SA64CA](#) [SMBJ12CATR](#)
[SMBJ33CATR](#) [SMBJ6.5A](#) [SMBJ8.0A](#) [ESD101-B1-02ELS](#) [E6327](#) [ESD112-B1-02EL](#) [E6327](#) [ESD7451N2T5G](#) [19180-510](#) [CPDT-5V0USP-](#)
[HF](#) [3.0SMCJ33CA-F](#) [3.0SMCJ36A-F](#) [HSPC16701B02TP](#) [JANTX1N6126A](#) [D3V3Q1B2DLP3-7](#) [D55V0M1B2WS-7](#) [SCM1293A-04SO](#)
[ESD200-B1-CSP0201](#) [E6327](#) [SM12-7](#) [CEN955](#) [W/DATA](#) [VESD12A1A-HD1-GS08](#) [CPDQC5V0-HF](#) [D1213A-01LP4-7B](#) [ESD101-B1-02EL](#)
[E6327](#) [AOZ8808DI-03](#) [5KP15A](#) [5KP48A](#) [5KP90A](#) [ESD3V3D7-TP](#) [15KPA36A-LF](#) [P4KE56CA](#) [P4KE68A](#) [P4KE91CATR](#) [P6KE120A](#)
[P6KE13CA](#) [P6KE43CA](#) [P6KE6.8CA](#) [P6KE8.2](#) [P6SMBJ20CA](#) [JANTX1N6072A](#) [SR2835ESKG](#) [SA90CA](#)