

Features

- 200W peak pulse power capability at 10/1000µs waveform, repetition rate (duty cycles):0.01%
- Excellent clamping capability
- Typical failure mode is a short circuit condition for current events exceeding component rating
- Plastic package is flammability rated V-0 per UL-94
- Meet MSL level1, per J-STD-020, lead-frame maximum peak of 260°C



Applications

TVS devices are ideal for the transient voltage clamp protection of I/O Interfaces, DC power line bus and other circuits used in Telecom, Computer, Industrial and Consumer electronic applications.

Function Diagram

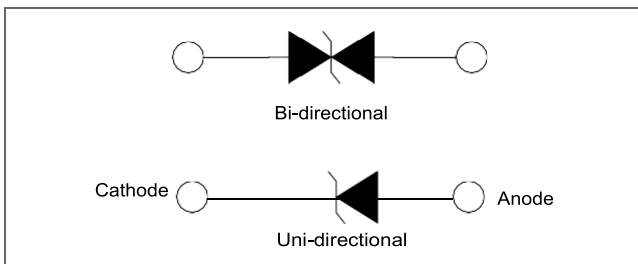

Maximum Ratings and Thermal Characteristics (T _A =25°C unless otherwise noted)			
Parameter	Symbol	Value	Unit
Peak Pulse Power Dissipation at T _A =25°C by 10/1000µs Waveform (Fig.3)	P _{PPM}	200	W
Power Dissipation on Infinite Heat Sink at T _L =50°C	P _D	1	W
Peak Forward Surge Current, 8.3ms Single Half Sine Wave (Note 1)	I _{FSM}	30	A
Maximum Instantaneous Forward Voltage at 50A for Unidirectional Only	V _F	3.5	V
Operating Temperature Range	T _J	-55 to 150	°C
Storage Temperature Range	T _{STG}	-55 to 150	°C

AGENCY	AGENCY FILE NUMBER
	Pending

Notes:

1. Measured on 8.3ms single half sine wave or equivalent square wave for unidirectional device only, duty cycle=4 per minute maximum.

Characteristics (T = 25°C unless otherwise noted)

Part Number (Uni)	Part Number (Bi)	Key Marking		Reverse Stand off Voltage V _R (Volts)	Breakdown Voltage V _{BR} (Volts) @ I _T		Test Current I _T (mA)	Maximum Clamping Voltage V _C @ I _{nn} (V)	Maximum Peak Pulse Current I _{pp} (A)	Maximum Reverse Leakage I _R @ V _R (μA)	Agency Approval 
		UNI	BI		MIN	MAX					
SMF5.0A	SMF5.0CA	05	05	5.0	6.40	7.00	10	9.2	21.7	200	
SMF6.0A	SMF6.0CA	06	06	6.0	6.67	7.37	10	10.3	19.4	200	
SMF6.5A	SMF6.5CA	6F	6F	6.5	7.22	7.98	10	11.2	17.9	150	
SMF7.0A	SMF7.0CA	07	07	7.0	7.78	8.60	10	12.0	16.7	100	
SMF7.5A	SMF7.5CA	7F	7F	7.5	8.33	9.21	1	12.9	15.5	50	
SMF8.0A	SMF8.0CA	08	08	8.0	8.89	9.83	1	13.6	14.7	50	
SMF8.5A	SMF8.5CA	8F	8F	8.5	9.44	10.40	1	14.4	13.8	20	
SMF9.0A	SMF9.0CA	09	09	9.0	10.00	11.10	1	15.4	13.0	10	
SMF10A	SMF10CA	10	10	10.0	11.10	12.30	1	17.0	11.8	5	
SMF11A	SMF11CA	11	11	11.0	12.20	13.50	1	18.2	11.0	1	
SMF12A	SMF12CA	12	12	12.0	13.30	14.70	1	19.9	10.1	1	
SMF13A	SMF13CA	13	13	13.0	14.40	15.90	1	21.5	9.3	1	
SMF14A	SMF14CA	14	14	14.0	15.60	17.20	1	23.2	8.6	1	
SMF15A	SMF15CA	15	15	15.0	16.70	18.50	1	24.4	8.2	1	
SMF16A	SMF16CA	16	16	16.0	17.80	19.70	1	26.0	7.7	1	
SMF17A	SMF17CA	17	17	17.0	18.90	20.90	1	27.6	7.2	1	
SMF18A	SMF18CA	18	18	18.0	20.00	22.10	1	29.2	6.8	1	
SMF20A	SMF20CA	20	20	20.0	22.20	24.50	1	32.4	6.2	1	
SMF22A	SMF22CA	22	22	22.0	24.40	26.90	1	35.5	5.6	1	
SMF24A	SMF24CA	24	24	24.0	26.70	29.50	1	38.9	5.1	1	
SMF26A	SMF26CA	26	26	26.0	28.90	31.90	1	42.1	4.8	1	
SMF28A	SMF28CA	28	28	28.0	31.10	34.40	1	45.4	4.4	1	
SMF30A	SMF30CA	30	30	30.0	33.30	36.80	1	48.4	4.1	1	
SMF33A	SMF33CA	33	33	33.0	36.70	40.60	1	53.3	3.8	1	
SMF36A	SMF36CA	36	36	36.0	40.00	44.20	1	58.1	3.4	1	
SMF40A	SMF40CA	40	40	40.0	44.40	49.10	1	64.5	3.1	1	
SMF43A	SMF43CA	43	43	43.0	47.80	52.80	1	69.4	2.8	1	
SMF45A	SMF45CA	45	45	45.0	50.00	55.30	1	72.7	2.7	1	
SMF48A	SMF48CA	48	48	48.0	53.30	58.90	1	77.4	2.6	1	
SMF51A	SMF51CA	51	51	51.0	56.70	62.70	1	82.4	2.4	1	
SMF54A	SMF54CA	54	54	54.0	60.00	66.30	1	87.1	2.3	1	
SMF58A	SMF58CA	58	58	58.0	64.40	71.20	1	93.6	2.1	1	
SMF60A	SMF60CA	60	60	60.0	66.70	73.70	1	96.8	2.0	1	
SMF64A	SMF64CA	64	64	64.0	71.10	78.60	1	103.0	1.9	1	
SMF70A	SMF70CA	70	70	70.0	77.80	86.00	1	113.0	1.8	1	
SMF75A	SMF75CA	75	75	75.0	83.30	92.10	1	121.0	1.7	1	
SMF78A	SMF78CA	78	78	78.0	86.70	95.80	1	126.0	1.6	1	
SMF85A	SMF85CA	85	85	85.0	94.40	104.0	1	137.0	1.5	1	
SMF90A	SMF90CA	90	90	90.0	100.0	111.0	1	146.0	1.4	1	
SMF100A	SMF100CA	A0	A0	100.0	111.0	123.0	1	162.0	1.2	1	
SMF110A	SMF110CA	B1	B1	110.0	122.0	135.0	1	177.0	1.1	1	



Part Number (Uni)	Part Number (Bi)	Marking		Reverse Stand off Voltage V_R (Volts)	Breakdown Voltage V_{BR} (Volts) @ I_T		Test Current I_T (mA)	Maximum Clamping Voltage V_C @ I_{DD} (V)	Maximum Peak Pulse Current I_{pp} (A)	Maximum Reverse Leakage I_R @ V_R (μ A)	Agency Approval 
		UNI	BI		MIN	MAX					
SMF120A	SMF120CA	C0	C0	120.0	133.00	147.00	1	193.0	1.0	1	
SMF130A	SMF130CA	E0	E0	130.0	144.00	159.00	1	209.0	0.9	1	
SMF150A	SMF150CA	F0	F0	150.0	167.00	185.00	1	243.0	0.8	1	
SMF160A	SMF160CA	G0	G0	160.0	178.00	197.00	1	259.0	0.8	1	
SMF170A	SMF170CA	H0	H0	170.0	189.00	209.00	1	275.0	0.7	1	
SMF180A	SMF180CA	I0	I0	180.0	201.00	222.00	1	292.0	0.7	1	
SMF188A	SMF188CA	J0	J0	188.0	209.00	231.00	1	304.0	0.7	1	
SMF200A	SMF200CA	K0	K0	200.0	224.00	247.00	1	324.0	0.6	1	

I-V Curve Characteristics

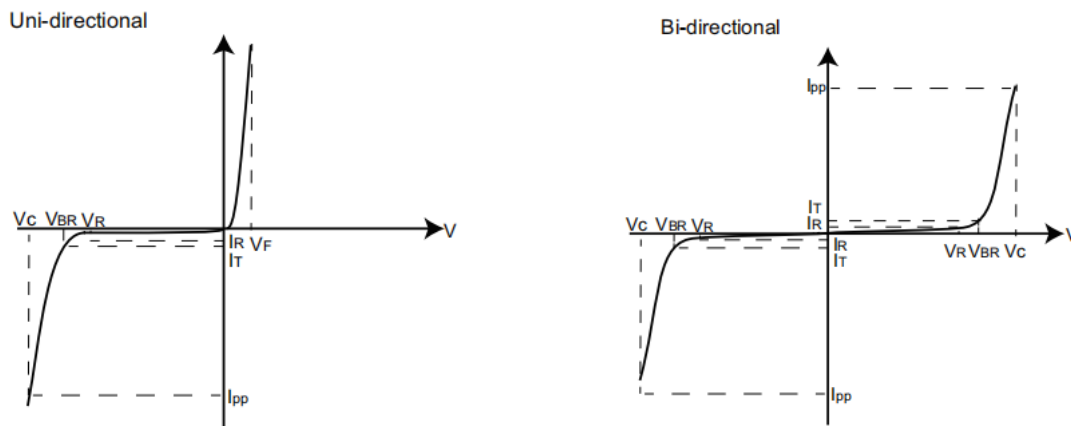

P_{PPM} Peak Pulse Power Dissipation -- Max power dissipation

V_R Stand-off Voltage -- Maximum voltage that can be applied to the TVS without operation

V_{BR} Breakdown Voltage -- Maximum voltage that flows through the TVS at a specified test current (I_T)

V_C Clamping Voltage -- Peak voltage measured across the TVS at a specified I_{PPM} (peak impulse current)

I_R Reverse Leakage Current -- Current measured at V_R

V_F Forward Voltage Drop for Uni-directional

Ratings and Characteristic Curves (T = 25°C unless otherwise noted)

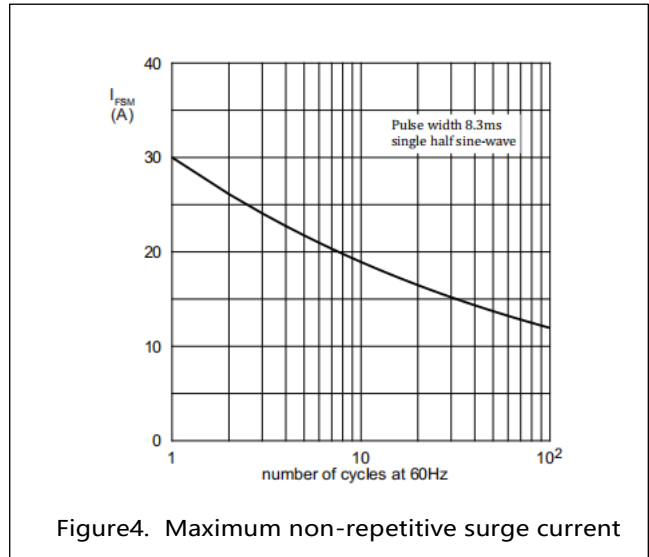
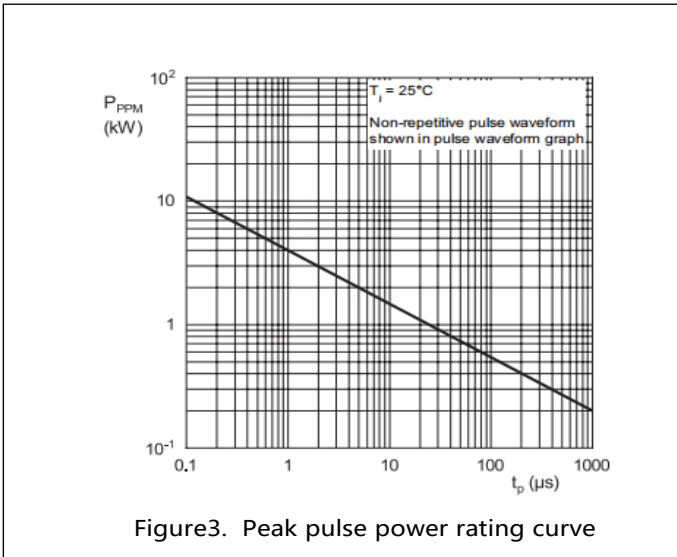
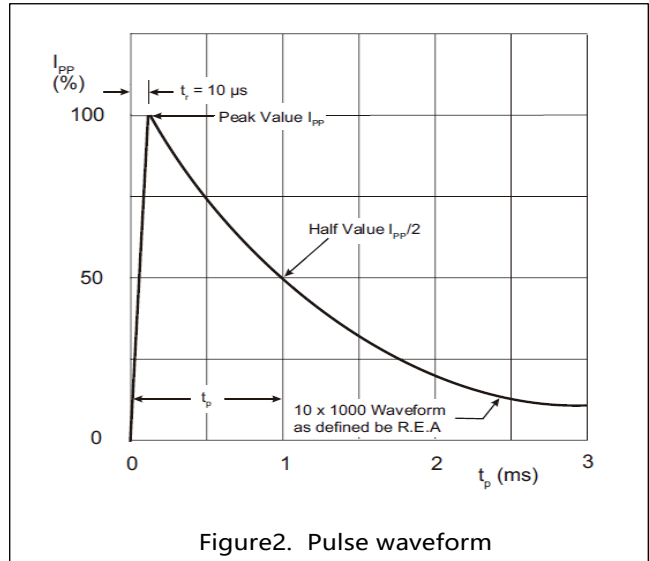
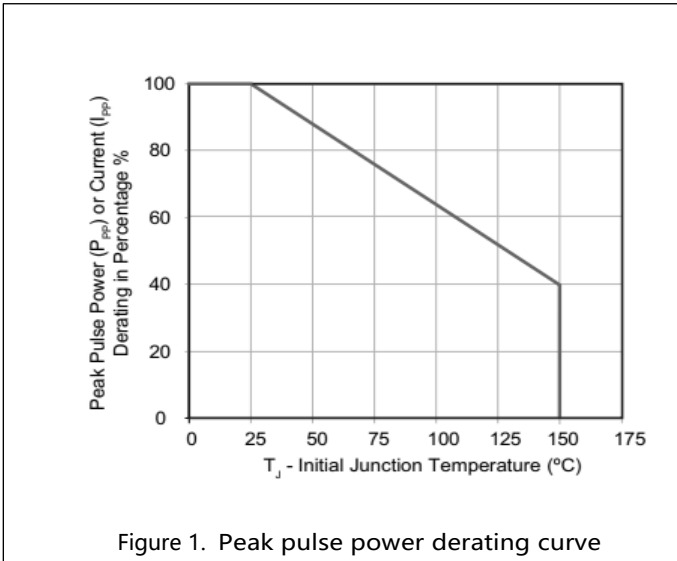

Soldering Parameters

Soldering profile

Reflow Condition		Lead-free assembly
Pre Heat	- Temperature Min ($T_{s(min)}$)	150°C
	- Temperature Max ($T_{s(max)}$)	200°C
	- Time (min to max) (t_s)	60 – 180 secs
Average ramp up rate (Liquidus Temp (T_A) to peak)		3°C/second max
$T_{s(max)}$ to T_A - Ramp-up Rate		3°C/second max
Reflow	- Temperature (T_A) (Liquidus)	217°C
	- Time (min to max) (t_s)	60 – 150 seconds
Peak Temperature (T_p)		260 ^{+0/-5} °C
Time within 5°C of actual peak Temperature (t_p)		20 – 40 seconds
Ramp-down Rate		6°C/second max
Time 25°C to peak Temperature (T_p)		8 minutes Max.
Do not exceed		260°C

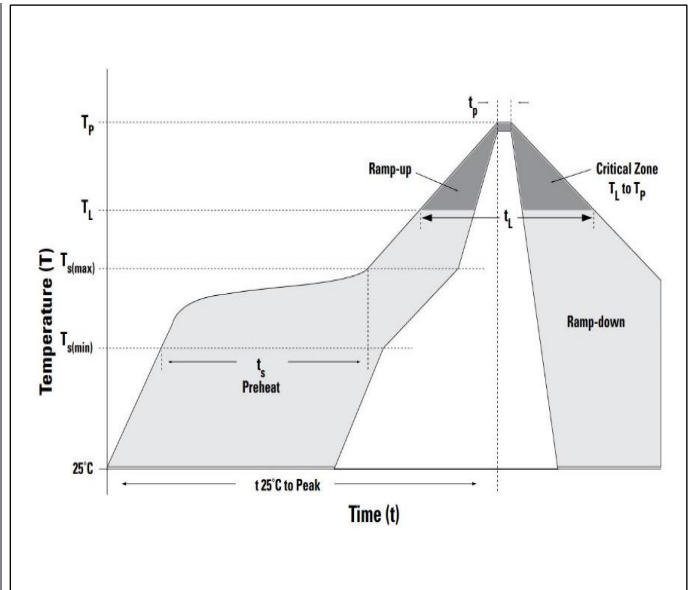



Dimensions

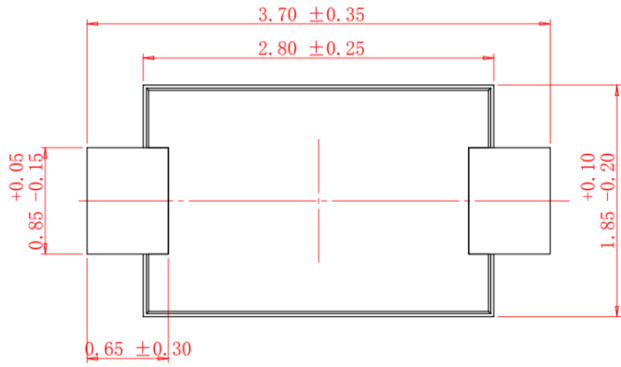
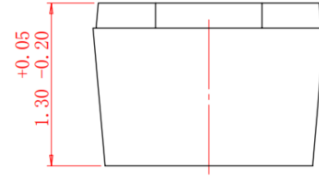
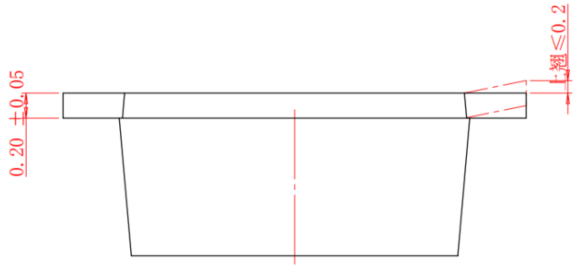

Mounting Pad Layout

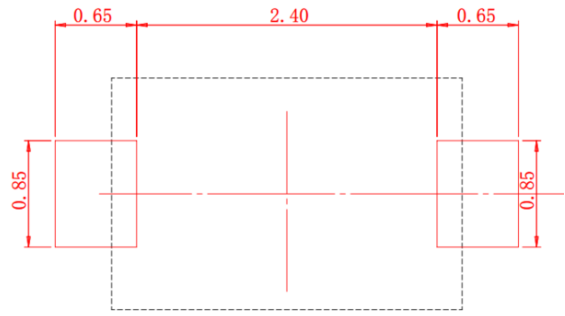

Part Numbering

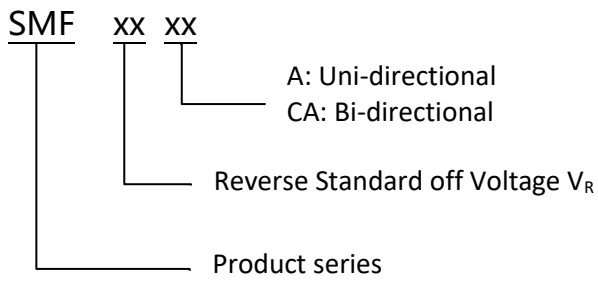

Part Marking

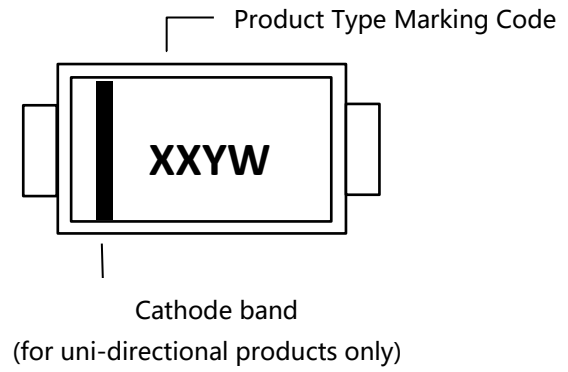

Packing

Part number	Package name	Small packing quantity	Packing method
SMFXXXX	SOD-123F	3000	Tape & Reel

Tape and Reel Specification

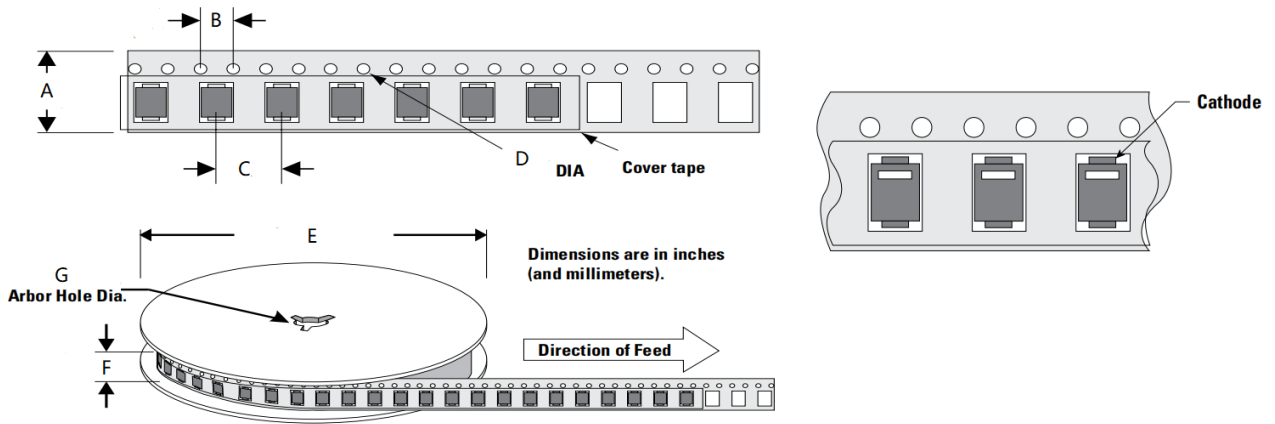

Symbol	Millimeter
A	8.00±0.10
B	4.00±0.10
C	4.00±0.10
D	1.55±0.05
E	177.80±2.00
F	11.50±1.00
G	13.30±0.30

Revision history of Specification

Version	Change Items	Effective Date
1.0	Initial Release	13-July-2021
1.1	Update Package Sizes	4 -Jan- 2024

X-ON Electronics

Largest Supplier of Electrical and Electronic Components

Click to view similar products for [ESD Suppressors / TVS Diodes](#) category:

Click to view products by [SCME](#) manufacturer:

Other Similar products are found below :

[60KS200C](#) [D18V0L1B2LP-7B](#) [D5V0F4U5P5-7](#) [NTE4902](#) [P4KE27CA](#) [P6KE11CA](#) [P6KE8.2A](#) [SA60CA](#) [SA64CA](#) [SMBJ12CATR](#)
[SMBJ33CATR](#) [SMBJ6.5A](#) [SMBJ8.0A](#) [ESD101-B1-02ELS](#) [E6327](#) [ESD112-B1-02EL](#) [E6327](#) [ESD7451N2T5G](#) [19180-510](#) [CPDT-5V0USP-](#)
[HF](#) [3.0SMCJ33CA-F](#) [3.0SMCJ36A-F](#) [HSPC16701B02TP](#) [JANTX1N6126A](#) [D3V3Q1B2DLP3-7](#) [D55V0M1B2WS-7](#) [SCM1293A-04SO](#)
[ESD200-B1-CSP0201](#) [E6327](#) [SM12-7](#) [CEN955](#) [W/DATA](#) [VESD12A1A-HD1-GS08](#) [CPDQC5V0-HF](#) [D1213A-01LP4-7B](#) [ESD101-B1-02EL](#)
[E6327](#) [AOZ8808DI-03](#) [5KP15A](#) [5KP48A](#) [5KP90A](#) [ESD3V3D7-TP](#) [15KPA36A-LF](#) [P4KE56CA](#) [P4KE68A](#) [P4KE91CATR](#) [P6KE120A](#)
[P6KE13CA](#) [P6KE43CA](#) [P6KE6.8CA](#) [P6KE8.2](#) [P6SMBJ20CA](#) [JANTX1N6072A](#) [SR2835ESKG](#) [SA90CA](#)