

## 18V Vin, 8A, High Efficiency Synchronous Step-down DCDC Converter

### FEATURES

- Wide 4.5V-18V Input Voltage Range
- 0.6V-7V Output Voltage Range
- 8A Continuous Output Current
- Integrated 25mΩ/12mΩ R<sub>dson</sub> of HS/LS Power MOSFETs
- Fixed 1ms Soft-start Time
- Selectable 400KHz, 800KHz and 1.2MHz Switching Frequencies
- Selectable PFM, USM and PWM Operation Modes
- Cycle-by-Cycle Current Limiting
- Output Over-Voltage Protection
- Over-Temperature Protection
- Available in a QFN 12-leads 2mmx3mm Package

### APPLICATIONS

- High End DTV
- Set-top Box, XDSL Modem, Personal Video Recorders
- Server, Cloud-Computing, Storage
- Telecom & Networking, Small-cell Base Stations, Point-of-Load (POL)
- IPCs, Factory Automation, PLC, Test Measurement

### DESCRIPTION

The SCT2280 is a high efficiency synchronous step-down DC-DC converter with 4.5V-18V input voltage range and adjustable output voltage down to 0.6V. It offers a small saving 2mmx3mm QFN package that supplies continuous 8A output current. The device fully integrates high-side and low-side power MOSFETs with 25mΩ/12mΩ on-resistance to minimize the conduction loss.

The SCT2280 adopts a Constant On-Time (COT) control to provide fast transient response and easy loop stabilization. The switching clock frequency can be selected from 400KHz, 800KHz and 1.2MHz for optimization of the filter size and output voltage ripple. The device offers fixed 1ms soft start to prevent inrush current during the startup of output voltage ramping. Power Good with open drain output signals that the output voltage is within regulation.

The SCT2280 has the MODE pin to select Pulse Frequency Modulation (PFM) operation mode to achieve the light load power save, or Ultrasonic Mode (USM) to keep the switching frequency above audible frequency areas during light-load or no-load conditions, or the PWM mode to achieve the small output ripple.

Full protection includes over current protection, under-voltage protection, and thermal shutdown.

The converter requires a minimum number of external components and is available in a QFN- 12 (2mmx3mm) package.

### TYPICAL APPLICATION

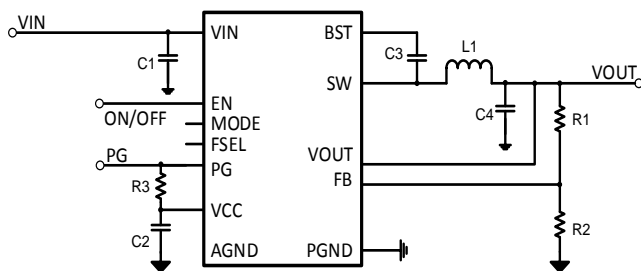

4.5V-18V, Synchronous Buck Converter

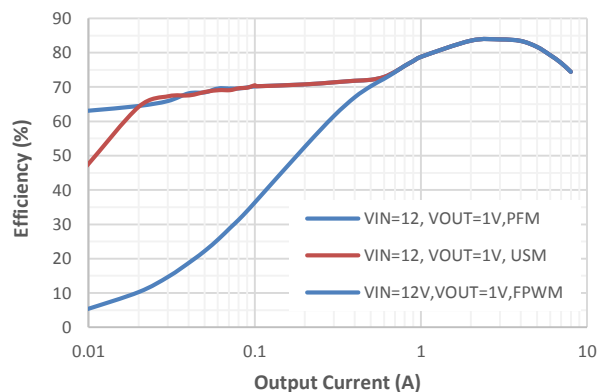

Vin=12V, Vout=1V, fsw=800kHz

# SCT2280

## REVISION HISTORY

NOTE: Page numbers for previous revisions may differ from page numbers in the current version.

Revision 1.0: Release to Market

Revision 1.3: Update TYPICAL CHARACTERISTICS

## DEVICE ORDER INFORMATION

PART NUMBER	PACKAGE MARKING	PACKAGE DESCRIPTION
SCT2280FPA	2280	12-Lead 2mm×3mm Plastic QFN
1) For Tape & Reel, Add Suffix R (e.g. SCT2280FPAR).		

## ABSOLUTE MAXIMUM RATINGS

Over operating free-air temperature unless otherwise noted<sup>(1)</sup>

DESCRIPTION	MIN	MAX	UNIT
VIN, VEN	-0.3	19	V
VBST	VSW-0.3	VST+6	V
VSW	-1	VIN+0.3	V
VMODE	-0.3	6.5	V
VFB	-0.3	6.5	V
VSEL	-0.3	6.5	V
VVOUT	-0.3	6.5	V
VPG	-0.3	6.5	V
Operating junction temperature TJ <sup>(2)</sup>	-40	125	°C
Storage temperature TSTG	-65	150	°C

## PIN CONFIGURATION

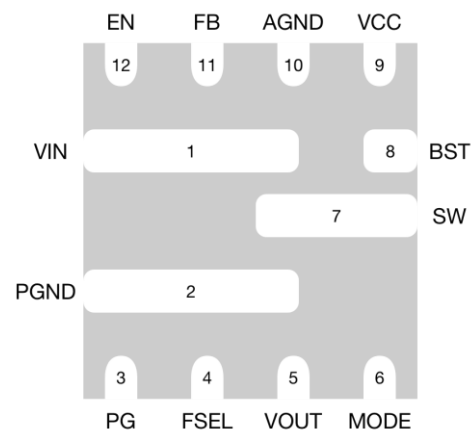

Figure 1. 12-Lead Plastic QFN  
(Top view: 2mmx3mm)

- (1) Stresses beyond those listed under Absolute Maximum Rating may cause device permanent damage. The device is not guaranteed to function outside of its Recommended Operation Conditions.
- (2) The IC includes over temperature protection to protect the device during overload conditions. Junction temperature will exceed 150°C when over temperature protection is active. Continuous operation above the specified maximum operating junction temperature will reduce lifetime.

## PIN FUNCTIONS

NAME	NO.	PIN FUNCTION
VIN	1	Input voltage. Decouple the input rail with at least 0.1uF input ceramic capacitor. Place the capacitor as close as to VIN and PGND pins as possible. Use wide PCB traces and multiple vias to make the connection. SCT2280 is a high efficiency power converter with 2-3ns fast turning on and turning off power MOSFETs for the best efficiency. If not placing the input capacitor close to VIN and GND pin, the voltage spike caused by trace parasitic inductance might EOS damage the device.
PGND	2	Power ground. Using wide PCB traces and multiple vias large enough to handle the load current.
PG	3	Power good open-drain output. PG is high if the output voltage is higher than 95% or lower than 105% of the nominal voltage.
FSEL	4	Switching frequency selection. Connecting to ground sets clock frequency to 400KHz. Floating sets clock frequency to 800KHz. Connecting to VCC sets clock frequency to 1.2MHz.

VOUT	5	VOUT is used to sense the output voltage of the buck regulator. Connect VOUT to the output capacitor of the regulator directly. Keep the VOUT sensing trace far away from the SW node. VIAs should also be avoided on the VOUT sensing trace. A trace larger than 25mil is required.
MODE	6	PFM, USM or FCCM mode selection. Connect the pin to VCC to force the device in Forced Continuous Current Modulation (FCCM) operation mode. Ground the pin to operate the device in Pulse Frequency Modulation (PFM) mode without Ultrasonic Mode (USM). Floating the pin to operate the device in PFM with USM.
SW	7	Connect SW to the inductor and bootstrap capacitor. SW is driven up to VIN through the high-side power MOSFET during on-time. The inductor current drives SW to negative voltage through low-side power MOSFET during off-time. Use wide and short PCB traces to make the connection. Keep the SW pattern area minimized.
BST	8	Bootstrap. Must connect a 0.1uF capacitor or greater between SW and BST to form a floating supply across the gate driver of high-side power MOSFET.
VCC	9	Internal VCC LDO output. The driver and control circuits are powered by VCC. Decouple with 1µF ceramic capacitor placed as close to VCC as possible.
AGND	10	Signal logic ground. AGND is the Kelvin connection to PGND.
FB	11	Feedback voltage Input. Connect FB to the tap of a resistor divider from output voltage to AGND to set up output voltage. The device regulates FB to the internal reference value of 0.6V typical.
EN	12	Enable logic input. EN is a digital input that controls the converter on or off. EN high turns on the device and EN low turns off the device. Connecting to VIN with a 100kΩ pull-up resistor can enable the device. Floating EN pin automatically starts up the converter.

## RECOMMENDED OPERATING CONDITIONS

Over operating free-air temperature range unless otherwise noted

PARAMETER	DEFINITION	MIN	MAX	UNIT
V <sub>IN</sub>	Input voltage range	4.5	18	V
V <sub>OUT</sub>	Output voltage range	0.6	7	V
T <sub>J</sub>	Operating junction temperature	-40	125	°C

## ESD RATINGS

PARAMETER	DEFINITION	MIN	MAX	UNIT
V <sub>ESD</sub>	Human Body Model (HBM), per ANSI-JEDEC-JS-001-2014 specification, all pins <sup>(1)</sup>	-2	+2	kV
	Charged Device Model (CDM), per ANSI-JEDEC-JS-002-2014specification, all pins <sup>(1)</sup>	-0.5	+0.5	kV

(1) JEDEC document JEP155 states that 500V HBM allows safe manufacturing with a standard ESD control process.

(2) JEDEC document JEP157 states that 250V CDM allows safe manufacturing with a standard ESD control process.

## THERMAL INFORMATION

PARAMETER	THERMAL METRIC	QFN-12L	UNIT
R <sub>θJA</sub>	Junction to ambient thermal resistance <sup>(1)</sup>	70	°C/W
R <sub>θJC</sub>	Junction to case thermal resistance <sup>(1)</sup>	15	

(1) SCT provides R<sub>θJA</sub> and R<sub>θJC</sub> numbers only as reference to estimate junction temperatures of the devices. R<sub>θJA</sub> and R<sub>θJC</sub> are not a characteristic of package itself, but of many other system level characteristics such as the design and layout of the printed circuit board (PCB) on which the SCT2280 is mounted, thermal pad size, and external environmental factors. The PCB board is a heat sink that is soldered to the leads and thermal pad of the SCT2280. Changing the design or configuration of the PCB board changes the efficiency of the heat sink and therefore the actual R<sub>θJA</sub> and R<sub>θJC</sub>.

# SCT2280

## ELECTRICAL CHARACTERISTICS

V<sub>IN</sub>=12V, T<sub>J</sub>=-40°C~125°C, typical value is tested under 25°C.

SYMBOL	PARAMETER	TEST CONDITION	MIN	TYP	MAX	UNIT
<b>Power Supply and Output</b>						
V <sub>IN</sub>	Operating input voltage		4.5		18	V
V <sub>INUVLO</sub>	Vin UVLO rising threshold		4	4.25	4.45	V
V <sub>INUVLO HYS</sub>	VIN UVLO Hysteresis			270		mV
I <sub>SD</sub>	Shutdown current	EN=0, Measured on VIN pin		1	3	uA
I <sub>Q</sub>	Quiescent current from VIN	EN=2V, Vout=5V, No load, No switching. Measured on VIN pin.		130		uA
V <sub>CC</sub>	V <sub>CC</sub> internal LDO regulator voltage	I <sub>VCC</sub> =0mA	4.75	5	5.25	V
V <sub>CC_LR</sub>	V <sub>CC</sub> internal LDO load regulation	I <sub>VCC</sub> =5mA		0.5		%
I <sub>VCC_LIM</sub>	V <sub>CC</sub> internal LDO current limit	V <sub>CC</sub> short to ground		27		mA
<b>Reference and Control Loop</b>						
V <sub>REF</sub>	Reference voltage of FB	4.5V<Vin<18V at Temp=25°C	0.594	0.6	0.606	V
I <sub>FB</sub>	FB pin leakage current	V <sub>FB</sub> =1.2V		100		nA
<b>Power MOSFETs</b>						
R <sub>DSON_H</sub>	High side FET on-resistance	V <sub>CC</sub> =5V		25		mΩ
R <sub>DSON_L</sub>	Low side FET on-resistance	V <sub>CC</sub> =5V		12		mΩ
<b>Enable and Soft-start</b>						
V <sub>EN_H</sub>	Enable high threshold			1.18	1.25	V
V <sub>EN_L</sub>	Enable low threshold		1.03	1.1		V
I <sub>EN</sub>	Enable pin input current	EN=1V	1	1.5	2	uA
I <sub>EN_HYS</sub>	Enable pin hysteresis current			4		uA
T <sub>SS</sub>	Soft-start time	VO <sub>UT</sub> 10% to 90%		1		ms
<b>Operation Mode</b>						
V <sub>MD_PWM</sub>	PWM mode with logic high threshold	V <sub>CC</sub> =5V	4.15			V
V <sub>MD_USM</sub>	PFM mode with USM logic threshold		1.5		3.5	V
V <sub>MD_PFM</sub>	PFM mode input logic low threshold				0.9	V
<b>Switching Frequency</b>						
F <sub>SW</sub>	Switching frequency	FSEL=0V		400		kHz
		FSEL=open		800		kHz
		FSEL=5V		1200		kHz
T <sub>ON_TIME</sub>	Minimum On-time	Guaranteed by design		60		ns
T <sub>OFF_TIME</sub>	Minimum Off-time			250		ns
<b>Power Good</b>						
PG <sub>Rising(in)</sub>	V <sub>FB</sub> rising, percentage of V <sub>REF</sub> (Good)			95		%
PG <sub>Falling(in)</sub>	V <sub>FB</sub> falling, percentage of V <sub>REF</sub>			85		%
PG <sub>Rising(out)</sub>	V <sub>FB</sub> rising, percentage of V <sub>REF</sub>			115		%
PG <sub>Falling(out)</sub>	V <sub>FB</sub> falling, percentage of V <sub>REF</sub> (Good)			105		%
PG <sub>TD</sub>	PG low to high delay			0.5		ms
V <sub>PG</sub>	Power Good PG pull-down strength	I <sub>PG</sub> =4mA		0.6		V
<b>Protection</b>						
I <sub>LIM_P</sub>	LS MOSFET positive current limit	From source to drain	8.5	10	11.5	A

<b>SYMBOL</b>	<b>PARAMETER</b>	<b>TEST CONDITION</b>	<b>MIN</b>	<b>TYP</b>	<b>MAX</b>	<b>UNIT</b>
I <sub>LIM_N</sub>	LS MOSFET negative current limit	From drain to source, MODE connects to VCC		2.5		A
T <sub>HICCUP</sub>	Hiccup waiting time	Numbers of soft start cycles		7		cycle
V <sub>OVP_R</sub>	V <sub>FB</sub> OVP threshold % of V <sub>REF</sub>	V <sub>FB</sub> rising		122		%
V <sub>OVP_F</sub>	V <sub>FB</sub> OVP threshold % of V <sub>REF</sub>	V <sub>FB</sub> falling		117		%
V <sub>UVP_F</sub>	V <sub>FB</sub> UVP threshold % of V <sub>REF</sub>	V <sub>FB</sub> falling		75		%
T <sub>SD</sub>	Thermal shutdown threshold	T <sub>J</sub> rising		163		°C
	Hysteresis			30		°C

## TYPICAL CHARACTERISTICS

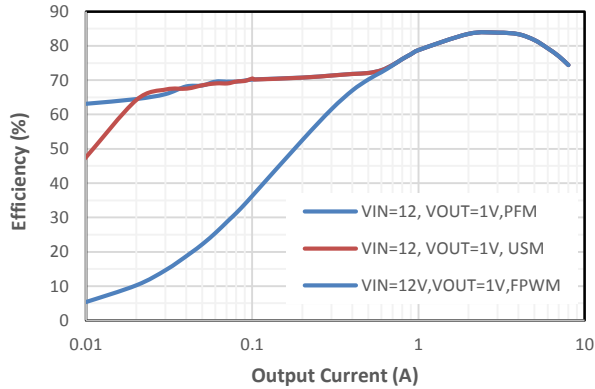

Figure 2. Efficiency vs Load Current, fsw=800kHz

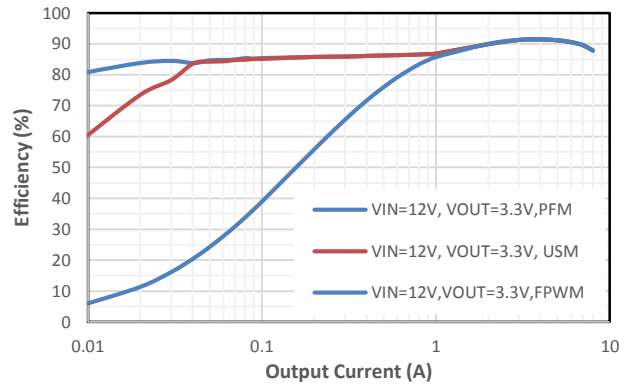

Figure 3. Efficiency vs Load Current, fsw=800kHz

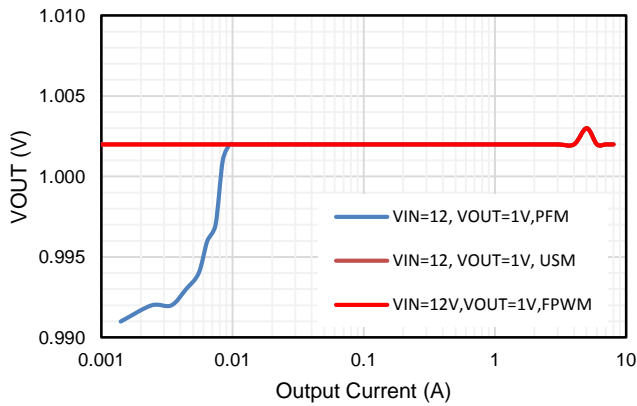

Figure 4. Load Regulation, fsw=800kHz

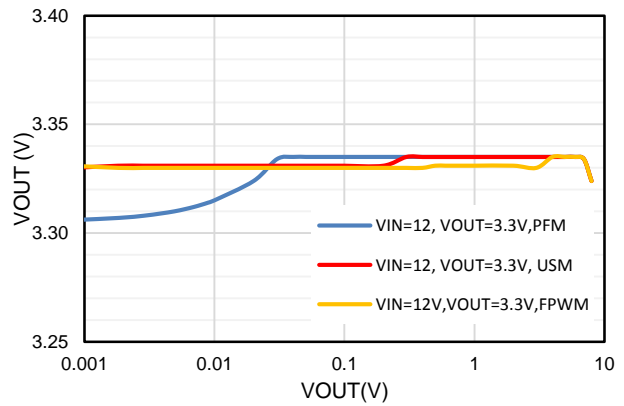

Figure 5. Load Regulation, fsw=800kHz

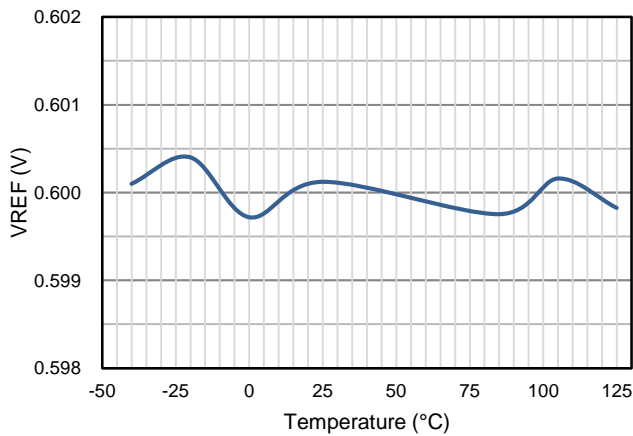

Figure 6. Reference Voltage vs Temperature

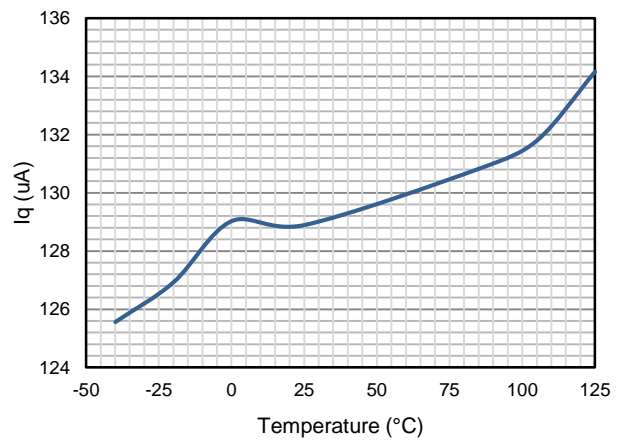

Figure 7. Quiescent Current vs Temperature

FUNCTIONAL BLOCK DIAGRAM

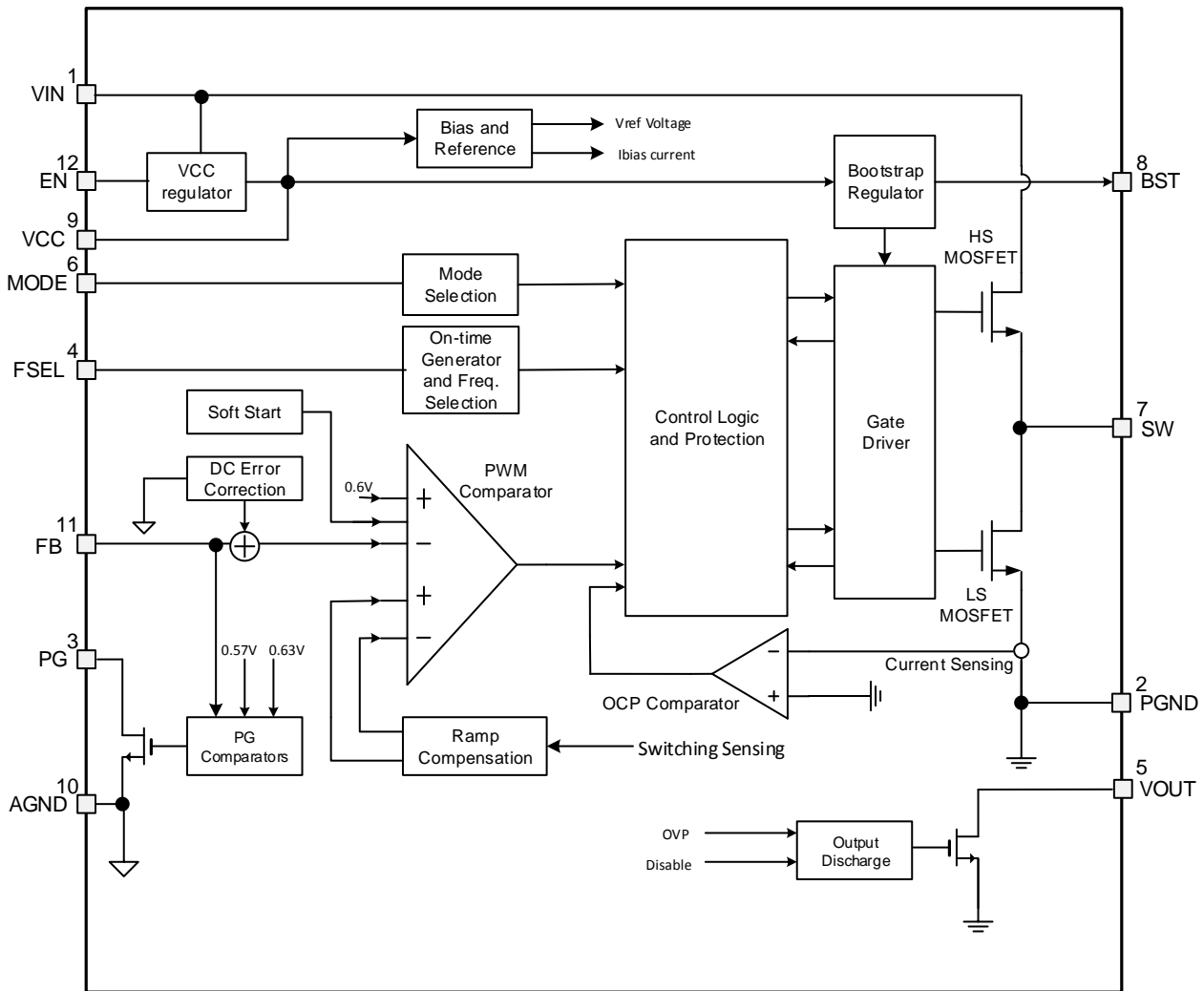

Figure 8. Functional Block Diagram

## OPERATION

### Overview

The SCT2280 is a 4.5V-18V input, 8A continuous output synchronous buck converter with built-in 25mΩ R<sub>ds(on)</sub> high-side and 12mΩ R<sub>ds(on)</sub> low-side power MOSFETs. It implements the Constant on-time (COT) mode control to regulate output voltage, providing excellent line and load transient response and simplifying the external frequency compensation design.

The switching frequency is selectable, 400kHz, 800kHz and 1.2MHz, by setting different FSEL status, to optimize either the power efficiency or the external components' sizes. The SCT2280 features an internal 1ms soft-start time to avoid large inrush current and output voltage overshoot during startup. The device features three different operation modes at light loading: Pulse Frequency Modulation (PFM) mode, and Ultra-Sonic Modulation (USM) mode, and PWM mode. The quiescent current is typically 130uA under no load and sleep mode condition to achieve high efficiency at light load.

The SCT2280 has a default input start-up voltage of 4.25V with 270mV hysteresis. The EN function features with a precision threshold that can be used to adjust the input voltage lockout thresholds with two external resistors to meet accurate higher UVLO system requirements. Floating EN pin enables the device with the internal pull-up current to the pin. Connecting EN pin to VIN with a 100kΩ resistor starts up the device automatically.

The SCT2280 full protection features include the input under-voltage lockout, the output over-voltage protection, over current protection with cycle-by-cycle current limiting and hiccup mode, output hard short protection and thermal shutdown protection.

### Constant on-time (COT) Mode Control

The SCT2280 employs constant on-time (COT) Mode control providing fast transient with pseudo fixed switching frequency. At the beginning of each switching cycle, since the feedback voltage (VFB) is lower than the internal reference voltage (VREF), the high-side MOSFET (Q1) is turned on during one on-time and the inductor current rises to charge up the output voltage. The on-time is determined by the input voltage and output voltage. After the on-time, the Q1 turns off and the low-side MOSFET (Q2) turns on after dead time duration. The inductor current drops and the output capacitors are discharged. When the output voltage decreases and the VFB decreased below the VFB, the Q1 turns during one on-time after another dead time duration. This repeats on cycle-by-cycle based.

The SCT2280 works with an internal compensation for optimizing the loop stability and transient response.

### Pulse Frequency Modulation (PFM) and Ultra-sonic Modulation (USM) Modes

Grounding the MODE pin makes the SCT2280 works at Pulse Frequency Modulation (PFM) mode to improve the power efficiency in light load. As the output current decreases from heavy load condition, the inductor current is also reduced. If the output current is reduced, the valley of the inductor current reaches the zero level, which is the boundary between continuous conduction and discontinuous conduction modes. The low-side MOSFET is turned off when a zero inductor current is detected. As the load current further decreases the converter runs into discontinuous conduction mode. The on-time is kept the same as it is in continuous conduction mode. The off-time increases as it takes more time to discharge the output with a smaller load current.

Floating the MODE pin makes the device works at PFM with Ultra-Sonic Modulation (USM) mode to keep the switching frequency out of the acoustic audible frequency. The USM mode block monitors the state of both high-side and low-side MOSFETs. When both high-side and low-side MOSFETs are off for 33us, the low-side MOSFET forces to turn on until the negative current limit is triggered or the feedback voltage (VFB) drops below the internal reference voltage (VREF).

### Forced Pulse Width Modulation (FPWM) mode

Connecting MODE pin to VCC, the SCT2280 forces the device operating at forced Pulse Width Modulation (PWM) mode with pseudo-fixed switching frequency regardless loading current. Operating in PWM mode can achieve smaller output voltage ripple compared with PFM or USM at light load. When the load current approaches zero, the high-side MOSFET current crosses zero and sinks current from output to maintain the constant output. Hence power



efficiency in light load is much lower than heavy load.

## Enable and Under Voltage Lockout Threshold

The SCT2280 is enabled when the VIN pin voltage rises above 4.25V and the EN pin voltage exceeds the enable threshold of 1.18V. The device is disabled when the VIN pin voltage falls below 3.98V or when the EN pin voltage is below 1.1V. An internal 1.5uA pull up current source to EN pin allows the device enable when EN pin floats.

EN pin is a high voltage pin that can be connected to VIN directly to start up the device.

For a higher system UVLO threshold, connect an external resistor divider (R1 and R2) shown in Figure 9 from VIN to EN. The UVLO rising and falling threshold can be calculated by Equation 1 and Equation 2 respectively.

$$V_{rise} = 1.18 * \left(1 + \frac{R1}{R2}\right) - 1.5\mu A * R1 \quad (1)$$

$$V_{fall} = 1.1 * \left(1 + \frac{R1}{R2}\right) - 5.5\mu A * R1 \quad (2)$$

where

- $V_{rise}$  is rising threshold of Vin UVLO
- $V_{fall}$  is falling threshold of Vin UVLO

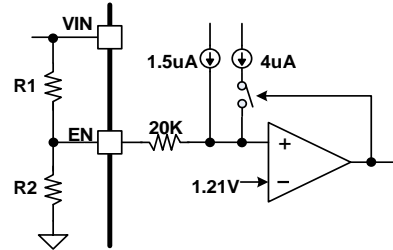

Figure 9. System UVLO by enable divide

## Output Voltage

The SCT2280 regulates the internal reference voltage at 0.6V with  $\pm 1\%$  tolerance over the operating temperature and voltage range. The output voltage is set by a resistor divider from the output node to the FB pin. It is recommended to use 1% tolerance or better resistors. Use Equation 3 to calculate resistance of resistor dividers. To improve efficiency at light loads, larger value resistors are recommended. However, if the values are too high, the regulator will be more susceptible to noise affecting output voltage accuracy.

$$R_{FB\_TOP} = \left(\frac{V_{OUT}}{V_{REF}} - 1\right) * R_{FB\_BOT} \quad (3)$$

where

- $R_{FB\_TOP}$  is the resistor connecting the output to the FB pin.
- $R_{FB\_BOT}$  is the resistor connecting the FB pin to the ground.

## Internal Soft-Start

The SCT2280 integrates an internal soft-start circuit that ramps the reference voltage from zero volts to 0.6V reference voltage in 1ms. If the EN pin is pulled below 1.1V, switching stops and the internal soft-start resets. The soft-start also resets during shutdown due to thermal overloading.

## Switching Frequency Selection

The switching frequency of the SCT2280 is selectable to be one of three options: 400KHz, 800KHz and 1200KHz. The switching frequency selection is programmed by FSEL pin. The selection information is shown in following table. The frequency setting is latched in at each power up and is not be able to be modified during operation. Cycling the input power or the EN pin can reselect the switching frequency

# SCT2280

**Table 1. FSEL Pin Set-up for Switching Frequency Selection**

FSEL Set-up	Connect to GND	Floating	Connect to VCC
Switching Frequency	400KHz	800KHz	1200KHz

## Mode Selection

The SCT2280 features three different operation modes at light load by easily programming the MODE pin. The programming information is listed in following table. The mode setting is latched in at each power up and is not be able to be modified during operation. Cycling the input power or the EN pin can reselect the switching frequency

**Table 2. MODE Pin Set-up for Mode Selection**

MODE Set-up	Floating	Connect to GND	Connect to VCC
Switching Frequency	PFM with USM	PFM	FCCM

## Power Good (PG)

The Power Good (PG) pin is the output of an open drain output. When the FB pin is typically between 95% and 105% of  $V_{REF}$  the PG is de-asserted and floats after a 500 $\mu$ s de-glitch time. A pull-up resistor of 10 k $\Omega$  to 100 k $\Omega$  is recommended to pull it up to VCC. The PGOOD pin is pulled low when the FB pin voltage falls under 85% or rises over 115% of  $V_{REF}$ , including UVP and OVP; or, in an event of thermal shutdown or during the soft-start period.

## Bootstrap Voltage Regulator

An external bootstrap capacitor between BOOT pin and SW pin powers the floating gate driver to high-side power MOSFET. The bootstrap capacitor voltage is charged from 5V VCC power when high-side power MOSFET is off and low-side power MOSFET is on.

## Over Current Limit and Hiccup Mode

The output over-current limit (OCL) is implemented in SCT2280 by using a cycle-by-cycle valley detect control circuit. The switch current is monitored during the OFF state of the high-side FET (Q1) by measuring the low-side FET(Q2) drain to source voltage. This voltage is proportional to the switch current. During the on time of the high-side FET switch, the switch current increases at a linear rate determined by input voltage, output voltage, the on-time and the output inductor value. During the on time of the low-side FET switch, this current decrease linearly. The average value of the switch current is the load current IOUT.

If the measured drain to source voltage of the low-side FET is above the voltage proportional to current limit, the low side FET stays on until the current level becomes lower than the OCL level which reduces the output current available. When the current is limited, the output voltage tends to drop because the load demand is higher than what the converter can support. When the output voltage falls below 75% of the target voltage, the UVP comparator detects it and shuts down the device immediately, the device re-starts after a hiccup time of 7ms. In this type of valley detect control the load current is higher than the OCL threshold by one half of the peak to peak inductor ripple current. When the overcurrent condition is removed, the output voltage returns to the regulated value. If an OCL condition happens during start-up then the device enters hiccup-mode immediately without a wait time of 1ms.

The hiccup protection mode above makes the average short circuit current to alleviate thermal issues and protect the regulator.

## Under-voltage Protection

The SCT2280 features the Under-voltage Protection (UVP) by monitoring the output voltage to detect the under-voltage voltage. When the feedback voltage falls below 75% of  $V_{REF}$ , the SCT2280 enters hiccup mode until the under-voltage scenario released.

## Over voltage Protection

The SCT2280 implements the Over-voltage Protection (OVP) circuitry to minimize output voltage overshoot during load transient, recovering from output fault condition or light load transient. The overvoltage comparator in OVP circuit compares the FB pin voltage to the internal reference voltage. When the feedback voltage rises higher than 122% of the feedback voltage, the OVP comparator output goes high and the circuit turns off the HS-FET driver. The LS-FET driver turns on until trigger negative current limit or FB below reference voltage. Then HS-FET turns on with normal ON-time and turn off, following with a LS-FET on until negative current limited triggered or FB lower than reference voltage. The device exits this regulation period when the feedback voltage falls below 117% of the reference voltage.

The SCT2280 offers output discharge under OVP and EN off condition. When OVP is triggered or EN is turn off, a discharge FET is turned on and VOUT pin is connected to a  $78\Omega$  discharge resistor.

## Thermal Shutdown

The SCT2280 protects the device from the damage during excessive heat and power dissipation conditions. Once the junction temperature exceeds  $163^{\circ}\text{C}$ , the internal thermal sensor stops power MOSFETs switching. When the junction temperature falls below  $133^{\circ}\text{C}$ , the device restarts with internal soft start phase.

## APPLICATION INFORMATION

### Typical Application

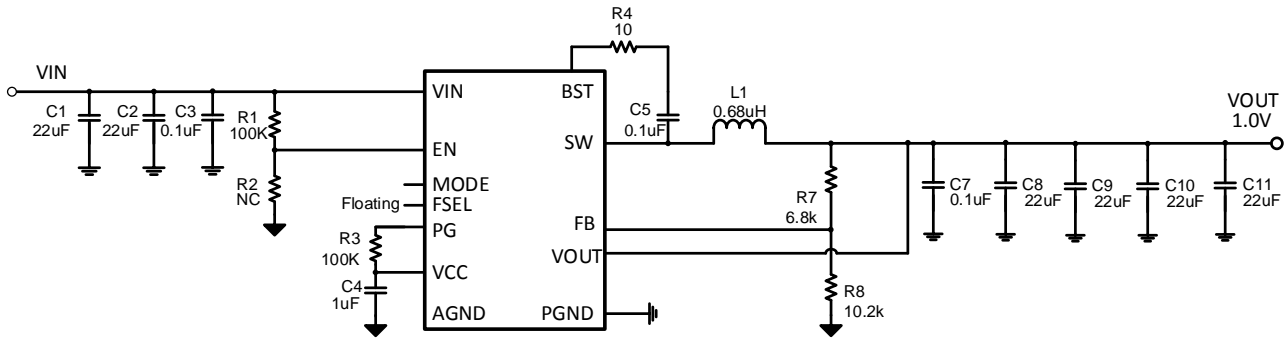

Figure 10. SCT2280 Design Example, 1V Output

### Design Parameters

Design Parameters	Example Value
Input Voltage	12V Normal 4.5V to 18V
Output Voltage	1V
Maximum Output Current	8 A
Switching Frequency	800 KHz

## Input Capacitor Selection

For good input voltage filtering, choose low-ESR ceramic capacitors. A ceramic capacitor 10 $\mu$ F is recommended for the decoupling capacitor and a 0.1 $\mu$ F ceramic bypass capacitor is recommended to be placed as close as possible to the VIN pin of the SCT2280.

Use Equation (4) to calculate the input voltage ripple:

$$\Delta V_{IN} = \frac{I_{OUT}}{C_{IN} \times f_{SW}} \times \frac{V_{OUT}}{V_{IN}} \times \left(1 - \frac{V_{OUT}}{V_{IN}}\right) \quad (4)$$

Where:

- $C_{IN}$  is the input capacitor value
- $f_{SW}$  is the converter switching frequency
- $I_{OUT}$  is the maximum load current

Due to the inductor current ripple, the input voltage changes if there is parasitic inductance and resistance between the power supply and the VIN pin. It is recommended to have enough input capacitance to make the input voltage ripple less than 100mV. Generally, a 25V/10uF input ceramic capacitor is recommended for most of applications. Choose the right capacitor value carefully with considering high-capacitance ceramic capacitors DC bias effect, which has a strong influence on the final effective capacitance.

## Inductor Selection

The performance of inductor affects the power supply's steady state operation, transient behavior, loop stability, and buck converter efficiency. The inductor value, DC resistance (DCR), and saturation current influences both efficiency and the magnitude of the output voltage ripple. Larger inductance value reduces inductor current ripple and therefore leads to lower output voltage ripple. For a fixed DCR, a larger value inductor yields higher efficiency via reduced RMS and core losses. However, a larger inductor within a given inductor family will generally have a greater series resistance, thereby counteracting this efficiency advantage.

Inductor values can have  $\pm 20\%$  or even  $\pm 30\%$  tolerance with no current bias. When the inductor current approaches saturation level, its inductance can decrease 20% to 35% from the value at 0-A current depending on how the inductor vendor defines saturation. When selecting an inductor, choose its rated current especially the saturation current larger than its peak current during the operation.

To calculate the current in the worst case, use the maximum input voltage, minimum output voltage, maximum load current and minimum switching frequency of the application, while considering the inductance with -30% tolerance and low-power conversion efficiency.

For a buck converter, calculate the inductor minimum value as shown in equation (6).

$$L_{INDMIN} = \frac{V_{OUT} \times (V_{INMAX} - V_{OUT})}{V_{INMAX} \times K_{IND} \times I_{OUT} \times f_{SW}} \quad (6)$$

Where:

- $K_{IND}$  is the coefficient of inductor ripple current relative to the maximum output current.

Therefore, the peak switching current of inductor,  $I_{LPEAK}$ , is calculated as in equation (7).

$$I_{LPEAK} = I_{OUT} + K_{IND} \times \frac{I_{OUT}}{2} \quad (7)$$

Set the peak current  $I_{LPEAK}$  lower than the current limit of the SCT2280 and select the inductor with the saturation current higher than the current limit. The inductor's DC resistance (DCR) and the core loss significantly affect the efficiency of power conversion. Core loss is related to the core material and different inductors have different core loss. For a certain inductor, larger current ripple generates higher DCR and ESR conduction losses and higher core loss.

# SCT2280

---

## Output Feedback Resistor Divider Selection

The SCT2280 features external programmable output voltage by using a resistor divider network R1 and R2 as shown in the typical application circuit Figure10. Use equation (12) to calculate the resistor divider values.

$$R_1 = \frac{(V_{OUT} - V_{ref}) \times R_2}{V_{ref}} \quad (12)$$

**Table 3 Recommended Component Values for Typical Output Voltage (Vin=12V)**

Fsw (kHz)	Vout (V)	L (uH)	R7 (kΩ)	R8 (kΩ)	Cout(uF)
400	1.0	1.0	6.8	10.2	88
	3.3	3.3	46.4	10.2	66
	5.0	3.3	75.0	10.2	66
800	1.0	0.56	6.8	10.2	88
	3.3	1.5	46.4	10.2	66
	5.0	1.5	75.0	10.2	66
1200	1.0	0.47	6.8	10.2	88
	3.3	1.2	46.4	10.2	66
	5.0	1.2	75.0	10.2	66

## Application Waveforms

Unless otherwise noted, the following conditions are VIN=12V, VO=1V, Temperature=25C.

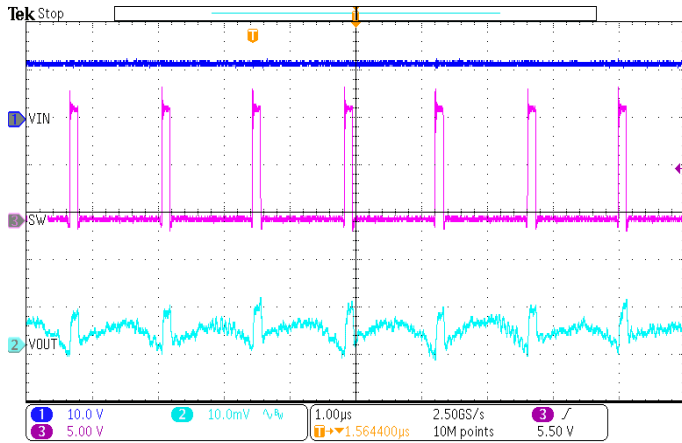

Figure 11. Switching Waveforms and Output Ripple ( IOUT=2A )

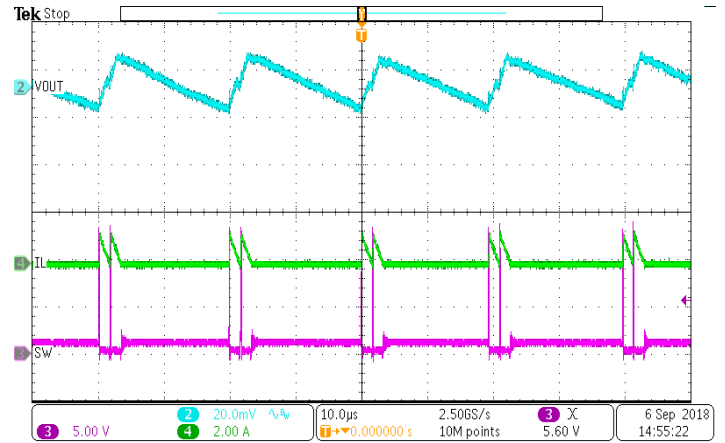

Figure 8. Switching Waveforms and Output Ripple in PFM ( IOUT=100mA )

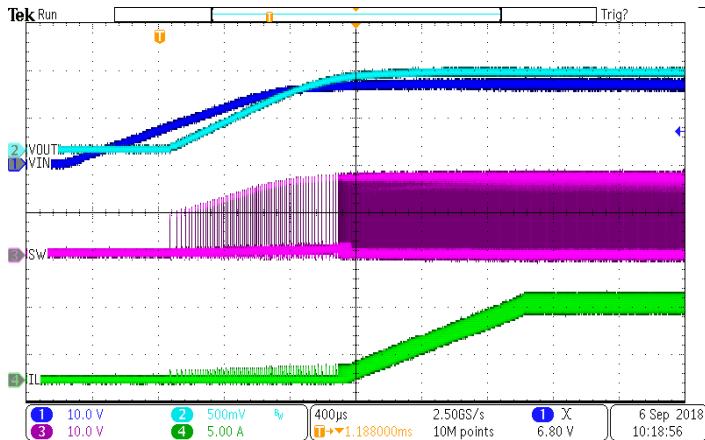

Figure 9. Power up

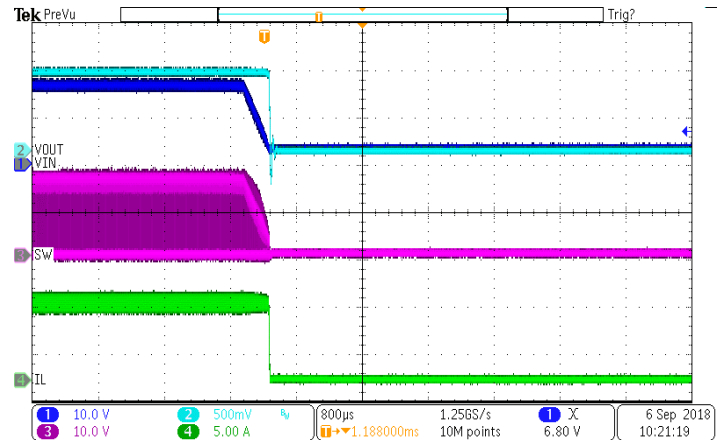

Figure 14. Power down

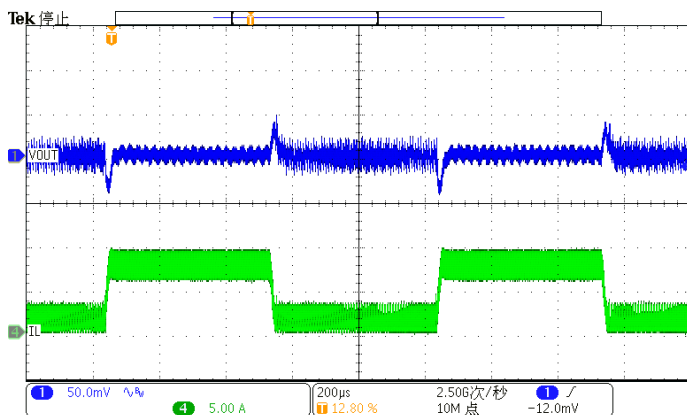

Figure 15. Load Transient (Vout=1V, Iout=0.8A to 7.2A)

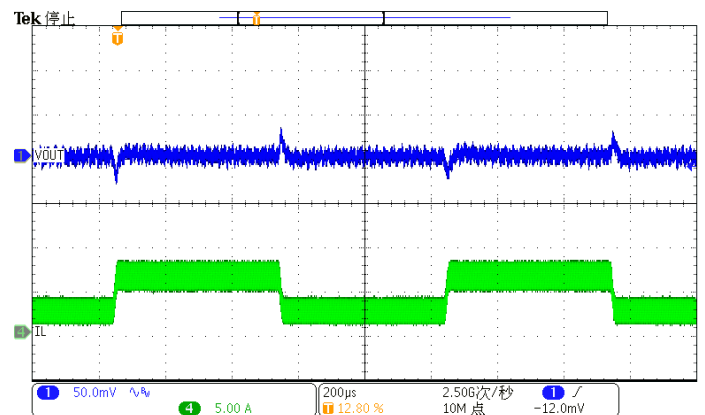

Figure 16. Load Transient (Vout=1V, Iout=2A to 6A)

## Layout Guideline

Proper PCB layout is a critical for SCT2280's stable and efficient operation. The traces conducting fast switching currents or voltages are easy to interact with stray inductance and parasitic capacitance to generate noise and degrade performance. For better results, follow these guidelines as below:

1. Place a low ESR ceramic capacitor as close to VIN pin and the ground as possible to reduce parasitic effect.
2. For operation at full rated load, the top side ground area must provide adequate heat dissipating area. Make sure top switching loop with power have lower impedance of grounding.
3. The bottom layer is a large ground plane connected to the ground plane on top layer by vias. it is recommended 8mil diameter drill holes of thermal vias, but a smaller via offers less risk of solder volume loss. On applications where solder volume loss thru the vias is of concern, plugging or tenting can be used to achieve a repeatable process.
4. Output inductor should be placed close to the SW pin. The area of the PCB conductor minimized to prevent excessive capacitive coupling.
5. UVLO adjust and feedback components should connect to small signal ground which must return to the GND pin without any interleaving with power ground.
6. Route BST resistor and capacitor with a minimized length between the BST PIN and SW PIN.

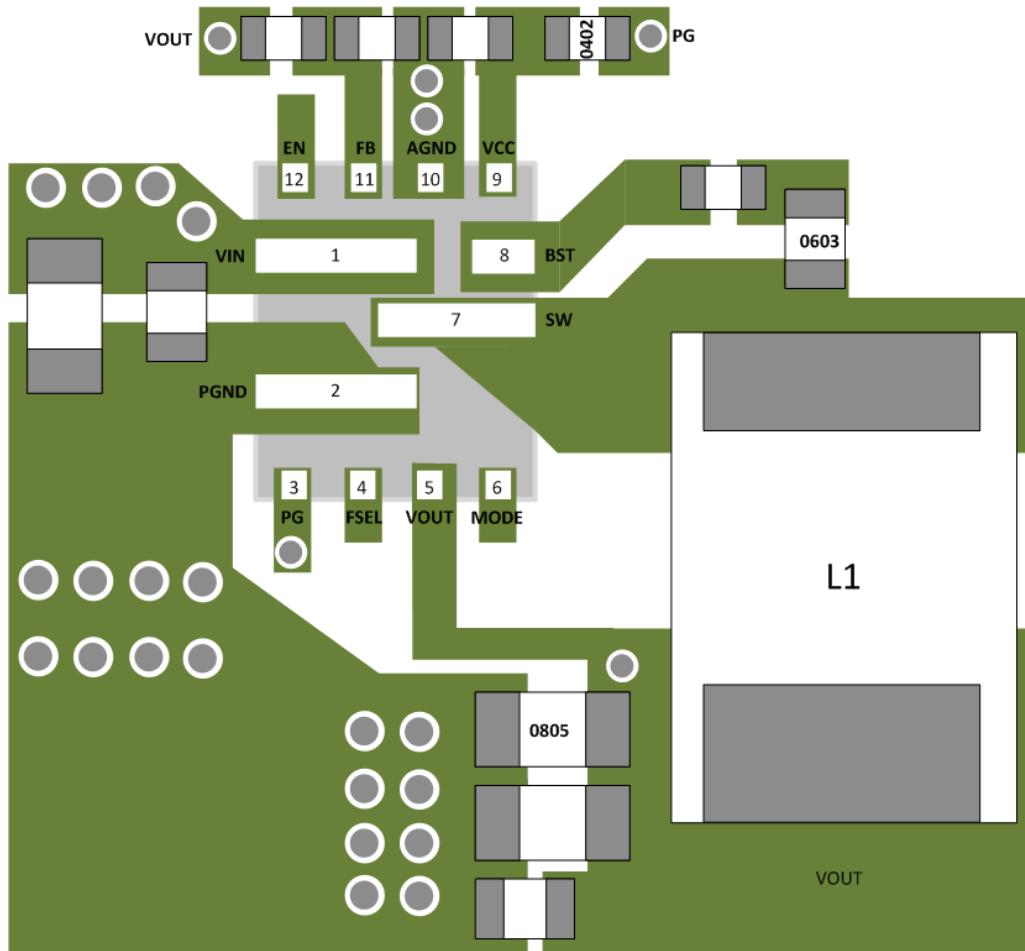
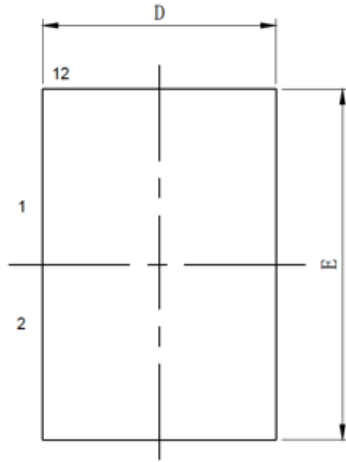

Figure 17. PCB Layout Example



PACKAGE INFORMATION



TOP VIEW

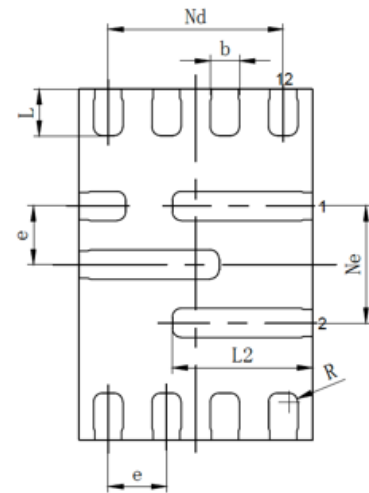
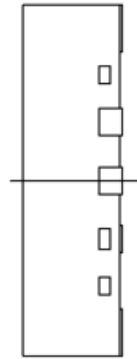

BOTTOM VIEW

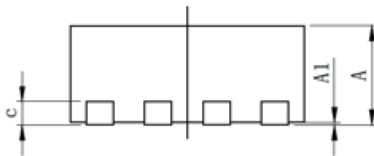

SIDE VIEW

SYMBOL	MILLIMETER		
	MIN	NOM	MAX
A	0.80	0.85	0.90
A1	0	0.02	0.05
b	0.20	0.25	0.30
c	0.15	0.20	0.25
D	1.95	2.00	2.05
e	0.50BSC		
Nd	1.50BSC		
Ne	1.00BSC		
E	2.95	3.00	3.05
L	0.35	0.40	0.45
L2	1.15	1.20	1.25
R	0.075REF		

NOTE:

1. Drawing proposed to be made a JEDEC package outline MO-220 variation.
2. Drawing not to scale.
3. Thermal pad shall be soldered on the board.
4. Dimensions of exposed pad on bottom of package do not include mold flash.
5. Contact PCB board fabrication for minimum solder mask web tolerances between the pins.

## TAPE AND REEL INFORMATION

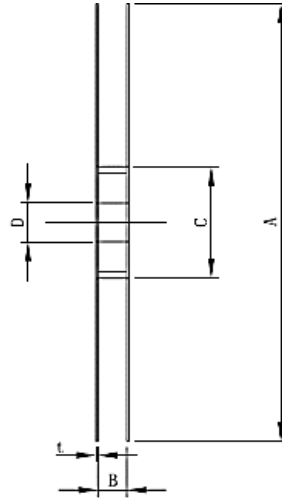
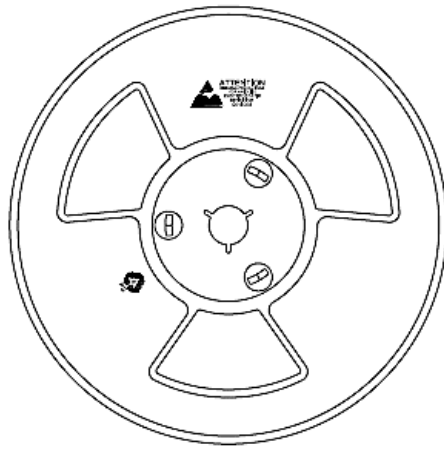

SYMBOL	MILLIMETER		
	MIN	NOM	MAX
A	328	329	330
B	11.80	12.80	13.80
C	99	100	101
D	13.00	13.30	13.60
t	1.70	2.00	2.30

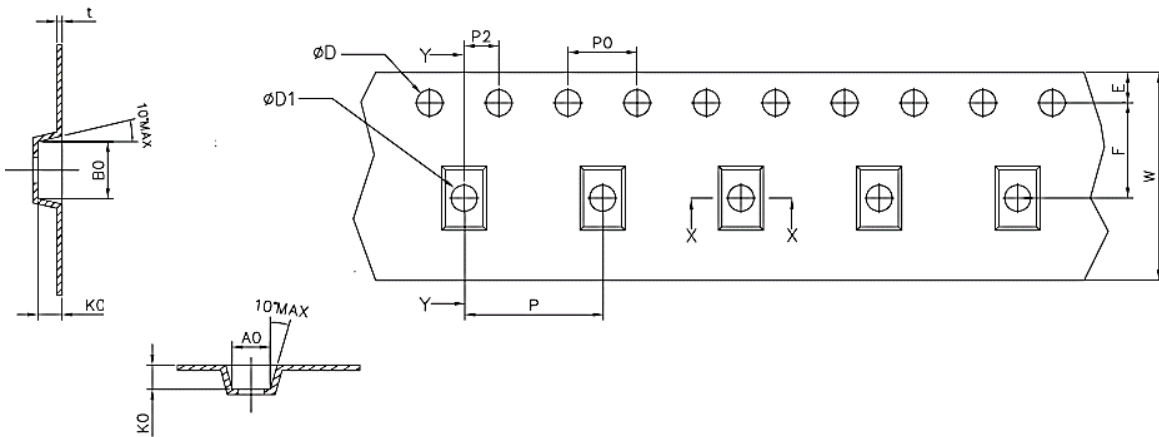

SYMBOL	MILLIMETER		
	MIN	NOM	MAX
E	1.65	1.75	1.85
F	5.45	5.50	5.55
P2	1.95	2.00	2.05
D		1.50	1.60
D1		1.50	1.75
P0	3.90	4.00	4.10
W	11.90	12.00	12.30
P	7.90	8.00	8.10
A0	2.10	2.20	2.30
B0	3.20	3.30	3.40
K0	1.04	1.14	1.24
t	0.23	0.25	0.27

## X-ON Electronics

Largest Supplier of Electrical and Electronic Components

*Click to view similar products for [Switching Controllers](#) category:*

*Click to view products by [SCT manufacturer](#):*

Other Similar products are found below :

[NCP1218AD65R2G](#) [NCP1244BD065R2G](#) [NCP1336ADR2G](#) [NCP6153MNTWG](#) [NCP81101BMNTXG](#) [NCP81205MNTXG](#) [SJE6600](#)  
[AZ7500BMTR-E1](#) [SG3845DM](#) [NCP1250BP65G](#) [NCP4204MNTXG](#) [NCP6132AMNR2G](#) [NCP81102MNTXG](#) [NCP81206MNTXG](#)  
[NCP1240AD065R2G](#) [NCP1240FD065R2G](#) [NCP1361BABAYSNT1G](#) [NCP1230P100G](#) [NX2124CSTR](#) [SG2845M](#) [NCP1366BABAYDR2G](#)  
[NCP81101MNTXG](#) [NCP81174NMNTXG](#) [NCP4308DMTTWG](#) [NCP4308AMTTWG](#) [NCP1366AABAYDR2G](#) [NCP1251FSN65T1G](#)  
[NCP1246BLD065R2G](#) [MB39A136PFT-G-BND-ERE1](#) [NCP1256BSN100T1G](#) [LV5768V-A-TLM-E](#) [NCP1365BABCYDR2G](#)  
[NCP1365AABCYDR2G](#) [NCP1246ALD065R2G](#) [AZ494AP-E1](#) [CR1510-10](#) [NCP4205MNTXG](#) [XRP6141ELTR-F](#) [RY8017](#) [LP6260SQVF](#)  
[LP6298QVF](#) [ISL6121LIB](#) [ISL6225CA](#) [ISL6244HRZ](#) [ISL6268CAZ](#) [ISL6315IRZ](#) [ISL6420AIAZ-TK](#) [ISL6420AIRZ](#) [ISL6420IAZ](#)  
[ISL6421ERZ](#)