

编号	SCTF202305308
日期	2023/5/22
版本	B01



承认书

SPECIFICATION FOR APPROVAL

客户名称 Customer Name:	立创商城
供应商物料名称 Part Name:	石英晶体谐振器
产品描述 Description:	SMD1612 26.000MHz/10pF
供应商物料料号 Part NO.:	SX0B26.000F1010F30
供应商名称 Supplier Name :	深圳市星通时频电子有限公司

PLEASE CONFIRM OUR SPECIFICATION. 敬请确认规格书之内容。

CUSTOMER APPROVAL 客户审批		
物料代号 PART NO. _____		
使用于机型 USED IN MODEL: _____		
工程部	品质部	采购部

(敬请承认后返回一份, 谢谢!)

SUPPLIER APPROVAL 供应商审批		
DGN.制表人	CKD. 校对	APPD. 审核、签章
吴丽红	李霞	胡华才

■ QUARTZ CRYSTAL UNIT SPECIFICATION

1. Crystal Unit Spec:

N0.	Item	Symb.	Electrical Spec.	Notes
1	Nominal Frequency 标称频率	f	26.000000 MHz	
2	Oscillation Mode 振荡模式		AT Fundamental	
3	Holder Type 封装		SMD1612	
4	Frequency Tolerance 常温频差	$\Delta f/f$	$\pm 10\text{ppm}$	at $25^{\circ}\text{C}\pm 2^{\circ}\text{C}$
5	Drive Level 激励功率	DL	10 μW Typical	See the 2.1
6	Load Capacitance 负载电容	CL	10pF	See the 2.2
7	Effective Resistance 谐振电阻	RR	200 Ω max.	See the 2.3
8	Shunt Capacitance 静电容	C0	3 pF Max.	
9	Drive Level Dependency 激励功率依赖性	DLD2	50 Ω max.	Sweep from 100nW to 100uW in 20 steps.
10	Temperature Drift 温度频差	f_tem	$\pm 30\text{ppm}$	Over Operating Temp. Range (Reference 25°C)
11	Spurious response 寄生响应	SPDB	-3dB max.	Start -1000ppm stop 5000ppm 30 steps power applied: 10dBm
12	Operating Temperature 工作温度范围	T_use	$-40\sim 85^{\circ}\text{C}$	
13	Storage Temperature Range 存储温度	T_stg	$-55\sim 125^{\circ}\text{C}$	
14	Insulation Resistance 绝缘阻抗	IR	500 M Ω	at DC 100V
15	Aging 年老化率	f_age	$\pm 3\text{ppm}$	1st Year
16	Measurement Condition 测量条件	Measured by S&A250B or equivalent, $T_A=25^{\circ}\text{C}\pm 2^{\circ}\text{C}$, RH=40%~70%		

2. Circuit Conditions Spec:

2.1 Drive Level (DL) 100 μW max.

(If Drive Level is too high, that may cause crystal resonator abnormal oscillation or damaged the main body of quartz)

2.2 Loading Capacitance (CL) : 10pF

(The total circuit load capacitance should be equal to the crystal (CL) values, too large or too small load, will result in frequency drift.)

2.3 Negative Resistance (-R) $\geq 1000\Omega$

(If -R more than ESR spec of 5 times will be better. If Negative Resistance is too low, that may cause crystal resonator stop oscillation or not easy to oscillate)

SHENZHEN SCTF ELECTRONICS CO., LTD		
DATE	Specification of quartz crystal 石英晶体谐振器规格书	Page:
2023/5/22	P/N: SX0B26.000F1010F30 Spec.NO.: SCTF202305308	3

DIMENSIONS

Product size (产品尺寸)

Units (单位): mm(毫米)

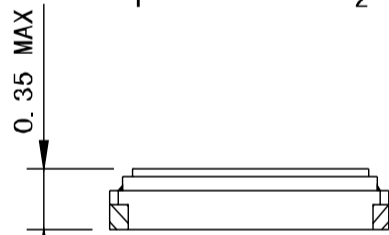
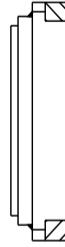
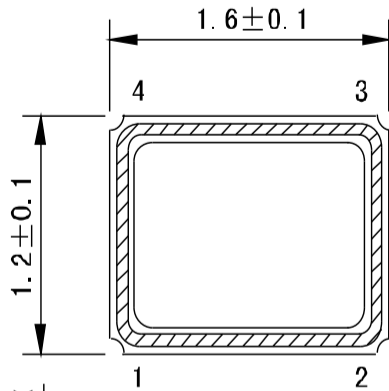

Pad size (焊盘尺寸)

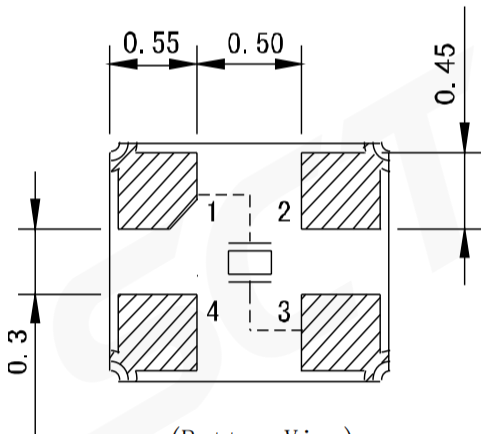

(Bottom View)
仰视图

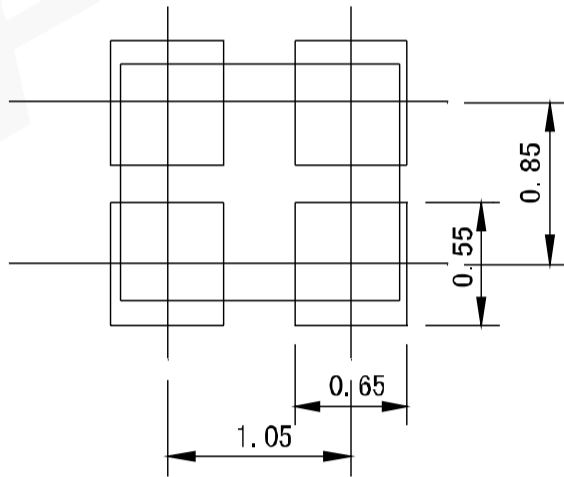

suggested solder pad layout

Note: #2, #4 is connected with a cover
(Please connect with GND or floating.)

SHENZHEN SCTF ELECTRONICS CO., LTD		
DATE	Specification of quartz crystal 石英晶体谐振器规格书	Page:
2023/5/22	P/N: SX0B26.000F1010F30 Spec.NO.: SCTF202305308	4

PRODUCT STRUCTURE & MARKING

Product Structure 产品结构

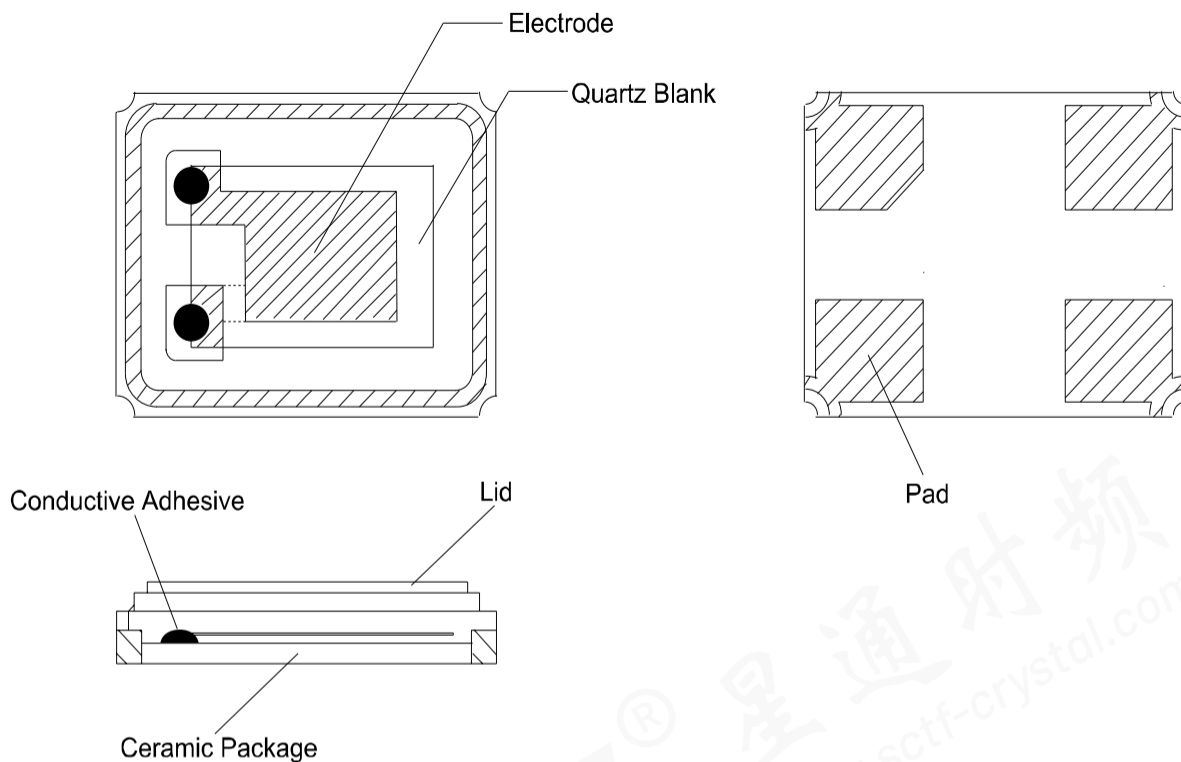

Marking 印字

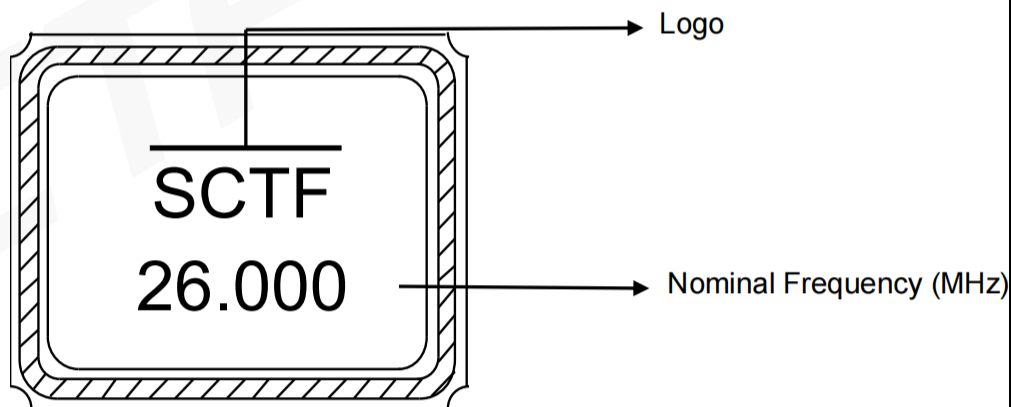

SHENZHEN SCTF ELECTRONICS CO. , LTD		
DATE	Specification of quartz crystal 石英晶体谐振器规格书	Page:
2023/5/22	P/N: SX0B26.000F1010F30 Spec.NO.: SCTF202305308	5

REFLOW PROFILES

Profile Feature	Sn-Pb Eutectic Assembly	Pb-Free Assembly
Preheat/Soak		
● Temperature Min (Ts min)	100 °C	150 °C
● Temperature Max (Ts max)	150 °C	200 °C
● Time (Ts min to Ts max)	60-120 seconds	60-120 seconds
Ramp-up rate (TL to Tp)	3 °C/second max.	3 °C/second max.
Time maintained above		
● Liquidous temperature (TL)	183 °C	217 °C
● Time (tL) maintained above TL	60-150 seconds	60-150 seconds
Peak package body temperature (Tp)	235°C	260°C
Time within 5 °C of the specified classification temperature (Tp)	20 seconds	30 seconds
Ramp-down rate (Tp to TL)	6 °C/second max.	6 °C/second max.
Time 25 °C to peak temperature	6 minutes max.	8 minutes max.
Suggest reflow times	3 Times max.	



SHENZHEN SCTF ELECTRONICS CO., LTD

DATE	Specification of quartz crystal 石英晶体谐振器规格书	Page:
2023/5/22	P/N: SX0B26.000F1010F30 Spec.NO.: SCTF202305308	6

RELIABILITY SPECIFICATION

序号 NO.	项目 ITEM	条件 CONDITIONS	合格标准 BASIS OF VERDICT
1	跌落 DROP	100cm高处自由跌落到3cm厚木板上,3次 High: 100cm; Thickness: 3cm; 3 times.	$\Delta FL \leq \pm 5 \text{ppm}$ $\Delta RR \leq RR(\text{max}) * 10\%$
2	振动 VIBRATION	频率 Frequency: 10~57.7Hz; 幅度 Amplitude: $\pm 0.75 \text{mm}$ 频率 Frequency: 57.7Hz~500Hz; 加速度幅度 acceleration rate: 98m/s ² 周期 Cycle time: 10-500-10Hz: 15min 振动方向 Direction: X, Y, Z 振动时间 Duration: 每个方向2小时 2 h/direction.	$\Delta FL \leq \pm 5 \text{ppm}$ $\Delta RR \leq RR(\text{max}) * 10\%$
3	温度变化 TEMPERATURE SHOCK	-40°C \pm 2°C (30min) \leftrightarrow 85°C \pm 2°C (30min); 循环10次 -40°C \pm 2°C (30min) \leftrightarrow 85°C \pm 2°C (30min); For 10 cycles	$\Delta FL \leq \pm 5 \text{ppm}$ $\Delta RR \leq RR(\text{max}) * 10\%$
4	湿热 HUMIDITY	温度: 40°C \pm 2°C; 湿度 90-95%; 时间: 96小时 Temp: 40°C \pm 2°C; Humidity: 90-95%; Times: 96h	$\Delta FL \leq \pm 5 \text{ppm}$ $\Delta RR \leq RR(\text{max}) * 10\%$
5	低温 COLD RESISTANCE	温度: -40°C \pm 2°C; 时间: 96小时 Temp: -40°C \pm 2°C; Times: 96h	$\Delta FL \leq \pm 5 \text{ppm}$ $\Delta RR \leq RR(\text{max}) * 10\%$
6	高温1 HEAT RESISTANCE 1	温度: 100°C \pm 2°C; 时间: 96小时 Temp: 100°C \pm 2°C; Times: 96h	$\Delta FL \leq \pm 5 \text{ppm}$ $\Delta RR \leq RR(\text{max}) * 10\%$
7	高温2 HEAT RESISTANCE 2	温度: 155°C \pm 2°C; 时间: 2小时 Temp: 155°C \pm 2°C; Times: 2h	$\Delta FL \leq \pm 5 \text{ppm}$ $\Delta RR \leq RR(\text{max}) * 10\%$
8	高温3 HEAT RESISTANCE 3	温度: 85°C \pm 2°C; 电压: 3.3V/5.0V; 时间: 96小时 Temp: 85°C \pm 2°C; Voltage: 3.3V/5.0V; Times: 96h	$\Delta FL \leq \pm 5 \text{ppm}$ $\Delta RR \leq RR(\text{max}) * 10\%$
9	回流焊 REFLOW	150°C \pm 5°C 保持120s后升到270°C \pm 5°C 保持10s, 升温和保温时间小于200s, 常温放置1~2h后测定 Keep 150 °C \pm 5 °C 120s and then rose to 270 °C \pm 5 °C for 10s, warming and holding time is less than the 200s, placed at room temperature 1 ~ 2h after test	$\Delta FL \leq \pm 5 \text{ppm}$ $\Delta RR \leq RR(\text{max}) * 10\%$
10	盐雾 SALT SPRAY	盐雾浓度: 5%; 温度: 35°C; 时间: 24小时 Salt density: 5%; Temp: 35 °C; Times: 24h	目测无明显腐蚀现象 Visual no significant corrosion.
11	老化 AGING	温度: 85°C; 时间: 30天 Temp: 85 °C; Times: 30days	$\Delta FL \leq \pm 5 \text{ppm}$ $\Delta RR \leq RR(\text{max}) * 10\%$
12	气密性 LEAKAGE	氦气(0.6~0.65MPa): 10分钟 He(0.6~0.65MPa): 10min	$\leq 3 * 10^{-9} \text{Pa} \cdot \text{m}^3 / \text{s}$
13	焊接 SOLDER	温度: 235°C \pm 5°C Temp: 235°C \pm 5°C	浸锡率大于90% Soldering tin rate greater than 90%

SHENZHEN SCTF ELECTRONICS CO. , LTD

DATE	Specification of quartz crystal 石英晶体谐振器规格书	Page:
2023/5/22	P/N: SX0B26.000F1010F30 Spec.NO.: SCTF202305308	7

PACKAGE

◆ Taping Specifications 编带规格

UNIT (单位): mm(毫米)

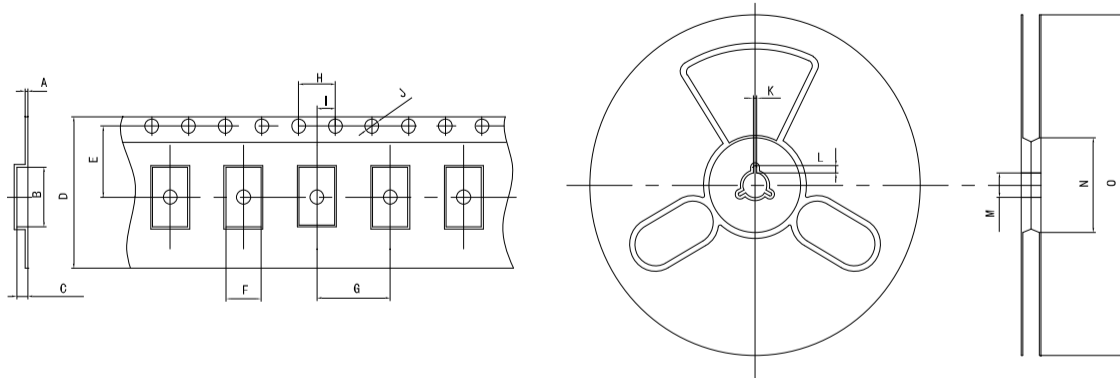

TEYE	A	B	C	D	E	F	G	H	I	J	K	L	M	N	O
1.6×1.2 SMD	0.25	1.85	0.45	8.00	3.50	1.45	4.00	4.00	2.00	1.55	2.00	4.00	13.00	60.00	180.00

◆ Packaging specifications 包装规格

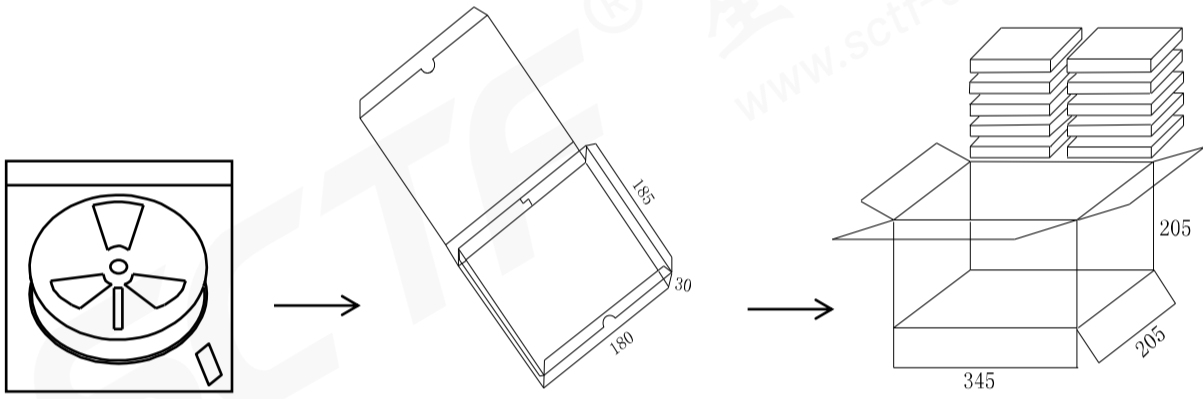

自封袋 (Bag)
3000只 = 1 轮
3000pcs = 1 Reel

内包装 (Inside package)
1 轮=1 盒
1 Reel=1 box

外包装 (Outside Package)
10 盒=1 箱
10 box=1 carton

SHENZHEN SCTF ELECTRONICS CO. , LTD		
DATE	Specification of quartz crystal 石英晶体谐振器规格书	Page:
2023/5/22	P/N: SX0B26.000F1010F30 Spec.NO.: SCTF202305308	8

X-ON Electronics

Largest Supplier of Electrical and Electronic Components

Click to view similar products for [Crystals](#) category:

Click to view products by [SCTF](#) manufacturer:

Other Similar products are found below :

[CX3225GB25000M0PPSZ1](#) [718-13.2-1](#) [7A-40.000MAAE-T](#) [FL2000085](#) [99-BU](#) [9B-15.360MBBK-B](#) [9C-7.680MBBK-T](#) [H10S-12.000-18-EXT-TR](#) [ABC2-6.000MHZ-D4Z-T](#) [ABLS-20.000MHZ-D2-T](#) [ABS071-32.768KHZ-6-T](#) [R38-32.768-12.5-5PPM-NPB](#) [BTD1062E05A-513](#) [21U15A-21.4MHZ](#) [RTX-781DF1-S-20.950](#) [LFXTAL066198Cutt](#) [9C-14.31818MBBK-T](#) [A-11.000MHZ-27](#) [ABL-27.000MHZ-B4Y-T](#) [ABM11-132-24.000MHZ-T3](#) [ABM3B1-25.000MHZ-D2Y-T](#) [SPT2A-.032768B](#) [SPT2A.032768G](#) [SSPT7F-9PF20-R](#) [LFXTAL065253Cutt](#) [LFXTAL066431Cutt](#) [XT9S20ANA14M7456](#) [XT9SNLANA16M](#) [7A-24.576MBBK-T](#) [7B-30.000MBBK-T](#) [MMCC2R32.7680KHZ](#) [7A-14.31818MBBK-T](#) [6504-202-1501](#) [6526-202-1501](#) [ABLS-12.000MHZ-B2Y-T](#) [7A-10.000MBBK-T](#) [SG636PCE-20.000MC](#) [3404](#) [E1SAA18-25.000M TR](#) [CM315D32768EZFT](#) [C1E-24.000-7-2020-R](#) [C1E-19.200-12-1530-X-R](#) [C1E-16.000-12-1530-X-R](#) [ABM11-16.000MHZ-9-B1U-T](#) [FL5000014](#) [EUCA18-3.1872M](#) [FX0800015](#) [425F35E027M0000](#) [FP0800018](#) [MS3V-T1R-32.768kHz-7pF-20PPM-TA-QC-Au](#)