

2CN Series 2.5 x 2.0 mm SMD Crystal Oscillator

2 : 2.5×2.0×0.81 mm | SMD2520-4P

CN : Low Phase Noise Crystal Oscillator

Feature

- Ceramic surface mount with Metal Lid
- CMOS compatible logic levels
- Tri-state function available
- RMS Phase Jitter: 0.3pSec max.
- RoHS Compliant / Pb Free

Applications

- Wireless Devices
- Internet of Things (IoT) devices
- Fibre Channel
- Ethernet/Gigabit Ethernet
- Portable Electronics



Electrical Specifications

Item	Symb.	Min.	Typ.	Max.	Unit	Notes
Frequency Range	Freq.	1.000		54.000	MHz	
Operating Temperature	T _{use}	-20		+70	°C	
		-40		+85	°C	
Storage Temperature Range	T _{stg}	-55		+125	°C	
Supply Voltage	V _{dd}	1.8		3.3	V	
Output Load	L _{CMOS}		15		pF	
Current Consumption	I _{cc}			10	mA	1MHz ≤ Freq. < 40MHz
				20		40MHz ≤ Freq. ≤ 54MHz
Duty Cycle	SYM	45		55	%	50 % V _{dd} level, L _{CMOS} ≤ 15 pF
Rise / Fall Time	T _R / T _F			5	nS	10% V _{dd} to 90% Level
Start-up Time	T _{str}			5	mS	To 90% of Final Amplitude
High output voltage	V _{OH}	0.9V _{dd}			V	
Low output voltage	V _{OL}			0.1V _{dd}	V	
Enable Voltage High (Logic 1)	V _{IH}	0.7V _{dd}			V	Output will be disable if OE is Logic 0 Output will be enable if OE is Logic 1 or open
Enable Voltage Low (Logic 0)	V _{IL}			0.3V _{dd}	V	
Enable Time	T _{PLZ}			150	uS	
RMS Phase Jitter	T _{RPJ}			0.3	pSec	Integrated 12KHz to 20MHz
Phase Noise @27MHz 3.3V	10 Hz	T _{PN}	-100		dBc/Hz	
			-125			
			-150			
			-160			
Aging	f _{age}			3	ppm	1st. Year at 25°C

Frequency Stability & Operating Temperature Range

Temp.	FT	±20ppm	±25ppm	±30ppm	±50ppm
	-20°C to +70°C	△	★	★	★
-40°C to +85°C		△	★	★	★

★: Available △: Conditional

All condition: Include 25°C tolerance, operating temperature range, input voltage change, aging, load change.

2CN Series 2.5 x 2.0 mm SMD Crystal Oscillator

2 : 2.5×2.0×0.81 mm | SMD2520-4P

CN : Low Phase Noise Crystal Oscillator

Dimensions (UNIT:mm)

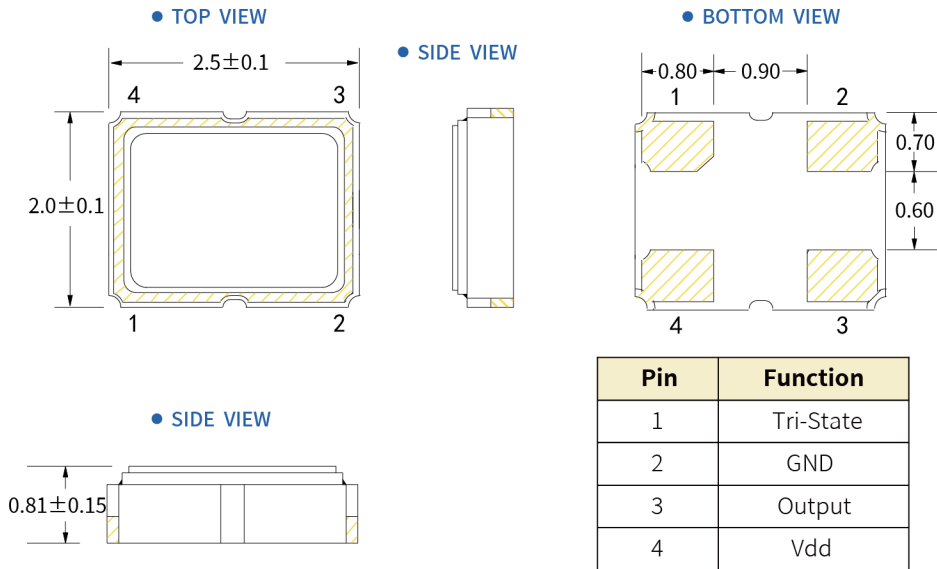

Solder pad layout (UNIT:mm)

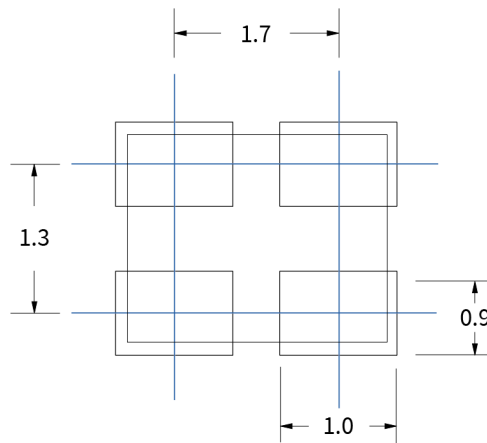

Options and Part Identification : Example SX2M11.2896B20F30TNF

Company	Ceramic Package	Frequency Code [MHz]	Supply Voltage	Frequency Tolerance	Operating Temperature	Frequency Drift	Output	Current Consumption	Phase Noise
SX	2M	X.XXX	B	20	F	30	T	N	F
Code Company	Code Ceramic Package	Frequency	Code Voltage	Code Frequency Tolerance	Code Frequency Tolerance	Code Frequency Drift	Code Output	Code Current	Code Phase Noise
SX SCTF	7M 7.0×5.0×1.3mm 5M 5.0×3.2×1.2mm 3M 3.2×2.5×0.95mm 2M 2.5×2.0×0.81mm 1M 2.0×1.6×0.75mm	11.2896 19.200 25.000 49.152	D 1.8V H 2.5V B 3.3V	10 ±10ppm 20 ±20ppm	E -20°C ~ +70°C F -40°C ~ +85°C	15 ±15ppm 20 ±20ppm 30 ±30ppm	T Squarewave	N Standard	F -145dBc/Hz 1KHz offset G -150dBc/Hz 1KHz offset H -155dBc/Hz 1KHz offset

If you have other parameter requirements, you can contact **SCTF** at any time.

2CN Series 2.5 x 2.0 mm SMD Crystal Oscillator

2 : 2.5×2.0×0.81 mm | SMD2520-4P

CN : Low Phase Noise Crystal Oscillator

Frequency Temperature Characteristics

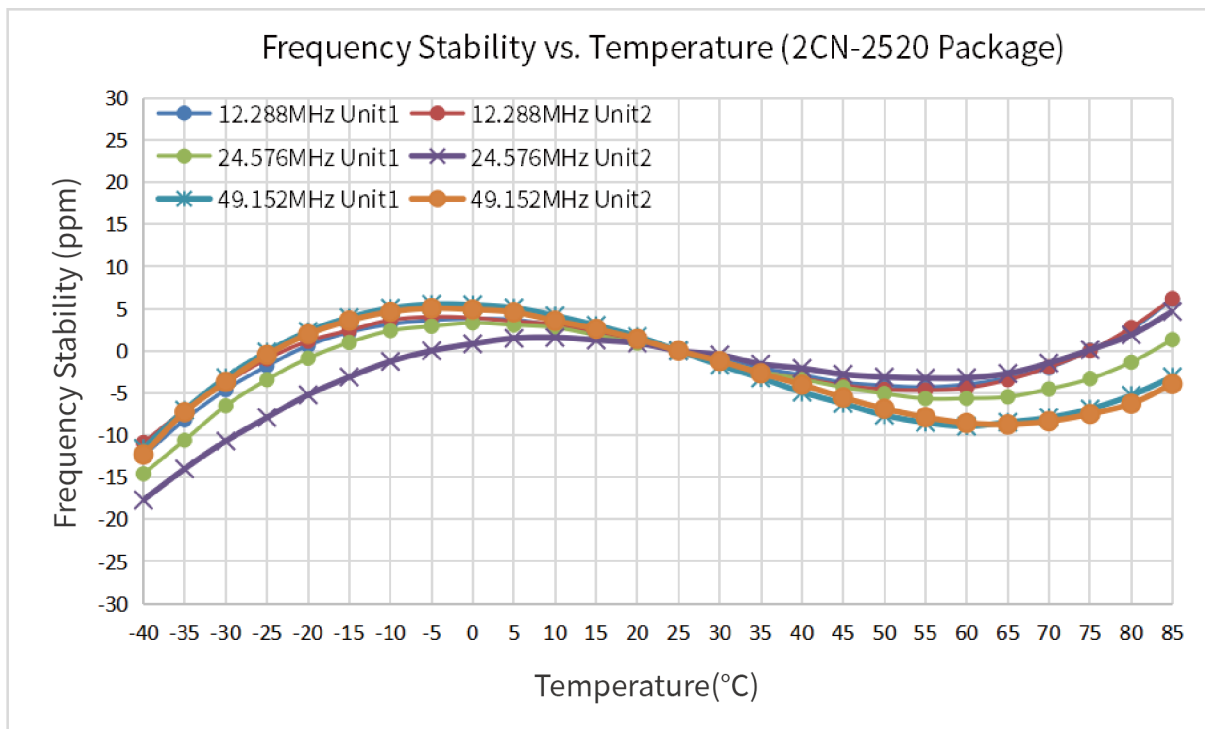

Product Structure & Marking Information

Product Structure

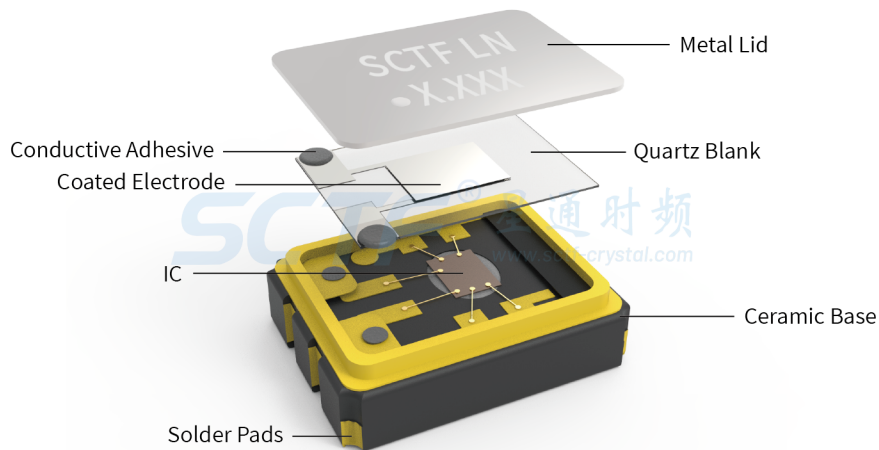

Marking Information

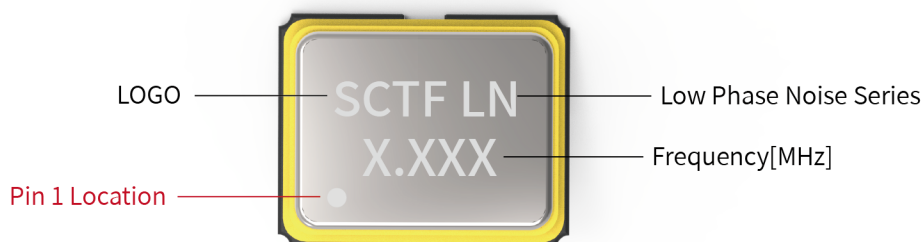

2CN Series 2.5 x 2.0 mm SMD Crystal Oscillator

2 : 2.5×2.0×0.81 mm | SMD2520-4P

CN : Low Phase Noise Crystal Oscillator

Suggested Reflow Profile

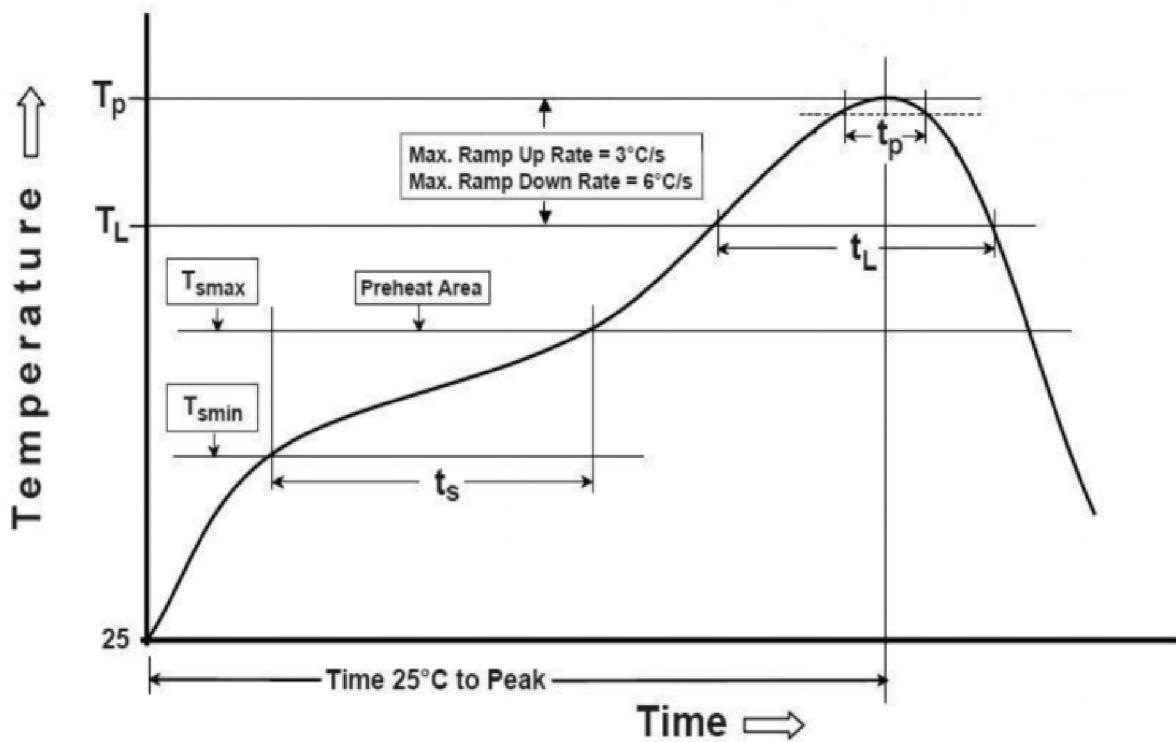

Profile Feature	Sn - Pb Eutectic Assembly	Preheat / Soak
Preheat / Soak <ul style="list-style-type: none"> ● Temperature Min (Ts min) ● Temperature Max (Ts max) ● Time (Ts min to Ts max) 	100°C 150°C 60-120 seconds	150°C 200°C 60-120 seconds
Ramp - up rate (TL to Tp)	3°C/ second max.	3°C/ second max.
Time maintained above <ul style="list-style-type: none"> ● Liquidous temperature (TL) ● Time (tL) maintained above TL 	183°C 60-150 seconds	217°C 60-150 seconds
Peak package body temperature (Tp)	235°C	260°C
Time within 5° C of the specified classification temperature (Tp)	20 seconds	30 seconds
Ramp - down rate (Tp to TL)	6°C/ second max.	6°C/ second max.
Time 25° C to peak temperature	6 minutes max.	8 minutes max.
Suggest reflow times	2 Times max.	

2CN Series 2.5 x 2.0 mm SMD Crystal Oscillator

2 : 2.5×2.0×0.81 mm | SMD2520-4P

CN : Low Phase Noise Crystal Oscillator

Testing Circuit

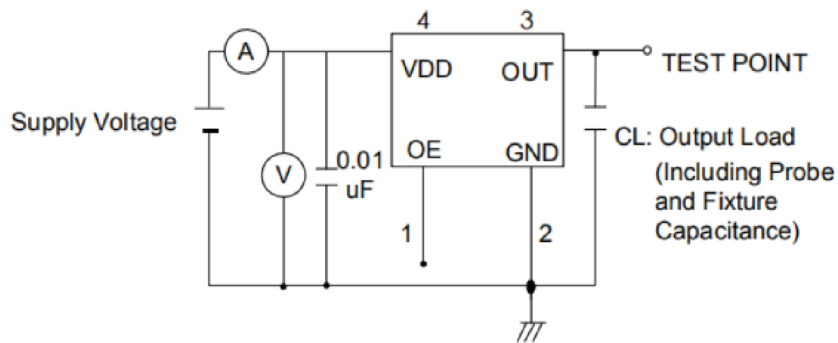

※ Notes: PIN 1 connected to Vdd or floating, the product is working properly; connected to GND, stops working.

Waveform Conditions

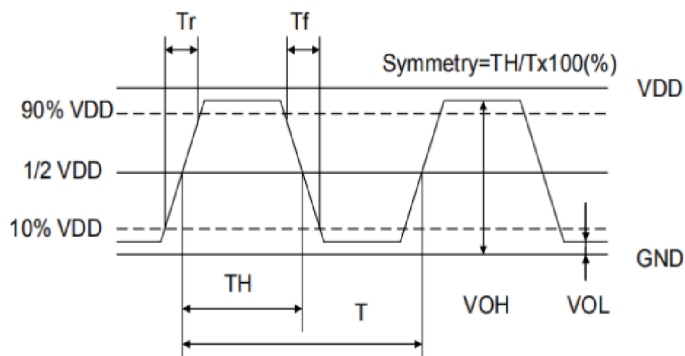

Waveform measurement system should have a min. bandwidth of 5 times the frequency being tested.

2CN Series 2.5 x 2.0 mm SMD Crystal Oscillator

2 : 2.5×2.0×0.81 mm | SMD2520-4P

CN : Low Phase Noise Crystal Oscillator

Representative Phase Noise Plots @ +25°C

- F=11.2896 MHz Vdd=3.3V CMOS Output RMS Phase Jitter=167.514 fsec

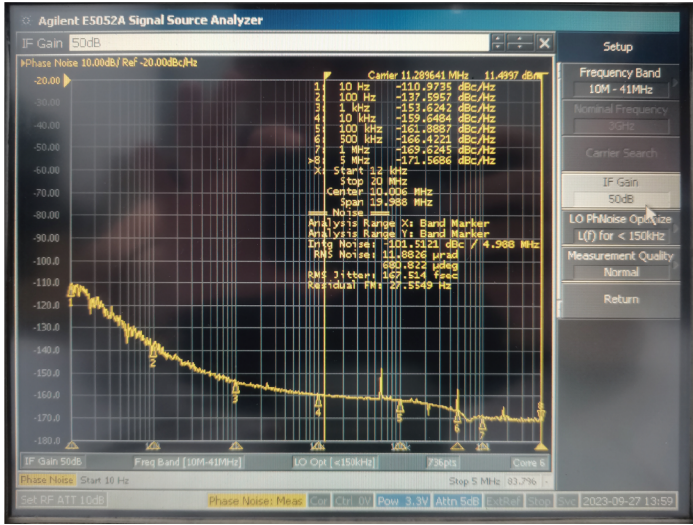

- F=22.5792 MHz Vdd=3.3V CMOS Output RMS Phase Jitter=87.278 fsec

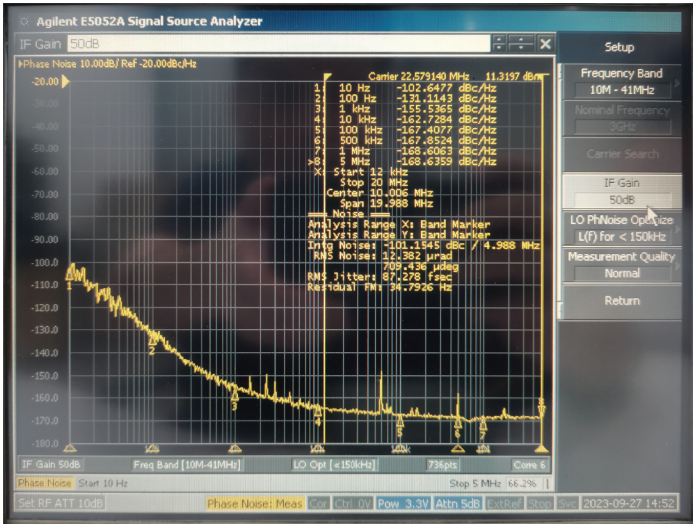

- F=45.1584 MHz Vdd=3.3V CMOS Output RMS Phase Jitter=50.161 fsec

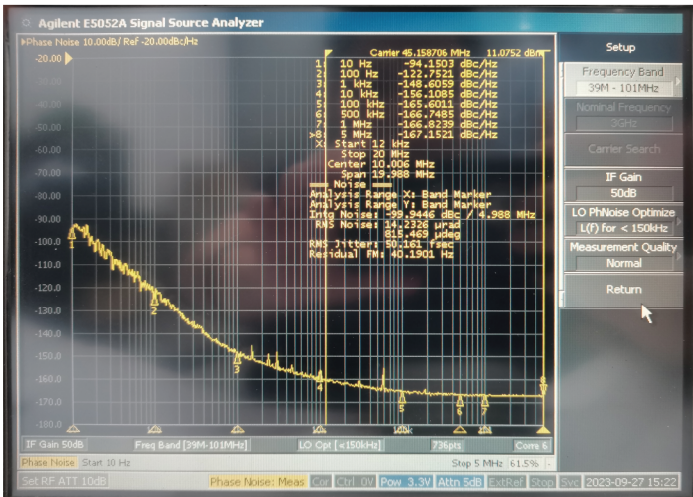

更新日期: 2024年4月9日

2CN Series 2.5 x 2.0 mm SMD Crystal Oscillator

2 : 2.5×2.0×0.81 mm | SMD2520-4P

CN : Low Phase Noise Crystal Oscillator

Packaging Information

T=Tape and reel (3,000pcs/reel)

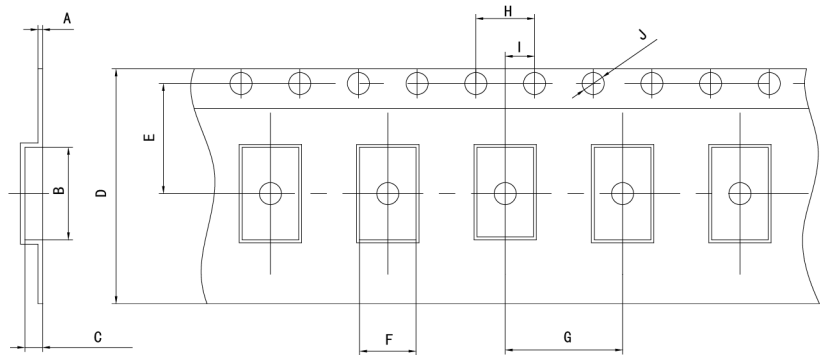
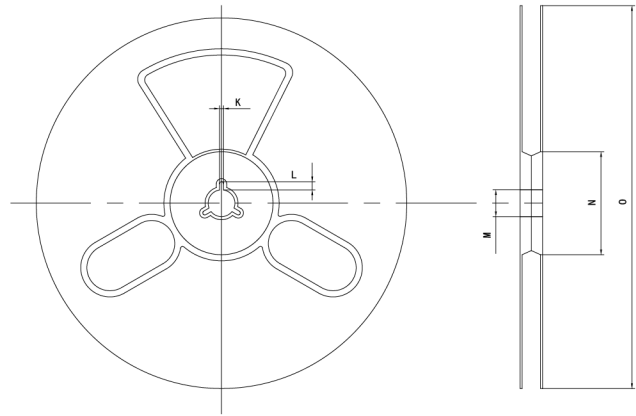

Pocket Tape Dimensions(mm)

Series	A	B	C	D	E	F	G	H	I	J	K	L	M	N	O
2CN	0.25±0.05	3.5±0.1	1.4±0.1	8.0±0.1	3.5±0.1	2.70±0.1	4.0±0.1	4.0±0.1	2.0±0.1	φ1.5±0.1	2.0±0.2	4.0±1.0	φ13±0.5	φ60±1	φ180±1

Common Frequencies – MHz

2CN Series				
1.000	1.024	1.8432	2.000	2.048
3.579545	3.6864	4.000	4.096	4.9152
6.0000	6.144	7.3728	8.0000	8.192
10.000	11.2896	12.000	12.288	13.000
13.560	14.31818	14.7456	16.000	16.384
16.9344	18.432	19.200	20.000	22.5792
24.000	24.576	25.000	26.000	27.000
27.120	30.000	30.720	32.000	32.768
33.000	33.333	33.3333	38.400	40.000
45.1584	48.000	49.152	50.000	

X-ON Electronics

Largest Supplier of Electrical and Electronic Components

Click to view similar products for [Standard Clock Oscillators](#) category:

Click to view products by [SCTF](#) manufacturer:

Other Similar products are found below :

[F335-25](#) [F535L-33.333](#) [F535L-50](#) [NBXHBA019LN1TAG](#) [SiT1602BI-22-33E-50.000000E](#) [SIT8918AA-11-33S-50.000000G](#) [SM4420TEV-40.0M-T1K](#) [F335-24](#) [F335-40](#) [F535L-10](#) [F535L-12](#) [F535L-24](#) [F535L-27](#) [PE7744DW-100.0M](#) [ASF1-3.686MHZ-N-K-S](#) [ASV-4.000MHZ-LCS-T](#) [XO57CTECNA3M6864](#) [601251](#) [SiT8503AI-18-33E-0.200000X](#) [SIT9122AI2C233E300.000000X](#) [9120AC-2D2-33E212.500000](#) [9102AI-243N25E100.00000](#) [8208AC-82-18E-25.00000](#) [8008AI-72-XXE-24.545454E](#) [8004AC-13-33E-133.33000X](#) [AS-4.9152-16-SMD-TR](#) [ASFL1-48.000MHZ-LC-T](#) [632L3I004M00000](#) [SIT8920AM-31-33E-25.0000](#) [DSC1028DI2-019.2000](#) [9121AC-2C3-25E100.00000](#) [9102AI-233N33E100.00000X](#) [9102AI-233N25E200.00000](#) [9102AI-232H25S125.00000](#) [9102AI-133N25E200.00000](#) [9102AC-283N25E200.00000](#) [9001AC-33-33E1-30.000](#) [8103AC-13-33E-12.00000X](#) [3921AI-2CF-33NZ125.000000](#) [5730-1SF](#) [XUN736000.032768I](#) [ASV-25.000MHZ-ECS-50-T](#) [EC3925ETTTS-100.000M TR](#) [SIT1602BC-83-33E-10.000000Y](#) [8003AI-12-33S-40.00000Y](#) [1602BI-13-33S-19.200000E](#) [8208AI-2F-18E-25.000000X](#) [8103AI-83-33E-33.00000X](#) [8208AI-8F-33E-66.666666X](#) [NX7031E0125.000000](#)