

5CM Series 5.0 x 3.2 mm SMD Crystal Oscillator

5 : 5.0×3.2×1.2 mm | SMD5032-4P

C : SPXO Crystal Oscillator

M : Multi Voltage

Feature

- Ceramic surface mount with Metal Lid
- CMOS compatible logic levels
- Tri-state function available
- Supply voltage range : 1.62V ~ 3.63V(Compatible with 1.8V, 2.5V, 3.3V)
- RoHS Compliant / Pb Free

Applications

- Wireless Devices
- Internet of Things (IoT) devices
- Ethernet/Gigabit Ethernet
- Audio, Video, Gaming products
- Micro base station



Electrical Specifications

Item	Symb.	Min.	Typ.	Max.	Unit	Notes
Frequency Range	Freq.	1.000		54.000	MHz	
Operating Temperature	T_use	-20		70	°C	
		-40		85	°C	
Storage Temperature Range	T_stg	-55		125	°C	
Supply Voltage	Vdd	1.62		3.63	V	
Output Load	L_CMOS		15		pF	
Current Consumption	Icc			10	mA	1MHz ≤ Freq. < 40MHz
				20		40MHz ≤ Freq. ≤ 54MHz
Duty Cycle	SYM	45		55	%	50 % Vdd level, L_CMOS ≤ 15 pF
Rise / Fall Time	T _R / T _F			5	nS	10% Vdd to 90% Level
Start-up Time	T_str			5	mS	To 90% of Final Amplitude
High output voltage	V _{OH}	0.9Vdd			V	
Low output voltage	V _{OL}			0.1Vdd	V	
Enable Voltage High (Logic 1)	V _{IH}	0.7Vdd			V	Output will be disable if OE is Logic 0 Output will be enable if OE is Logic 1 or open
Enable Voltage Low (Logic 0)	V _{IL}			0.3Vdd	V	
Aging	f_age			3	ppm	1st. Year at 25°C

Frequency Stability & Operating Temperature Range

Temp. \ FT	±20ppm	±25ppm	±30ppm	±50ppm
-20°C to +70°C	△	★	★	★
-40°C to +85°C		△	★	★

★: Available △: Conditional

All condition: Include 25°C tolerance, operating temperature range, input voltage change, aging, load change.

5CM Series 5.0 x 3.2 mm SMD Crystal Oscillator

5 : 5.0×3.2×1.2 mm | SMD5032-4P

C : SPXO Crystal Oscillator

M : Multi Voltage

Dimensions (UNIT:mm)

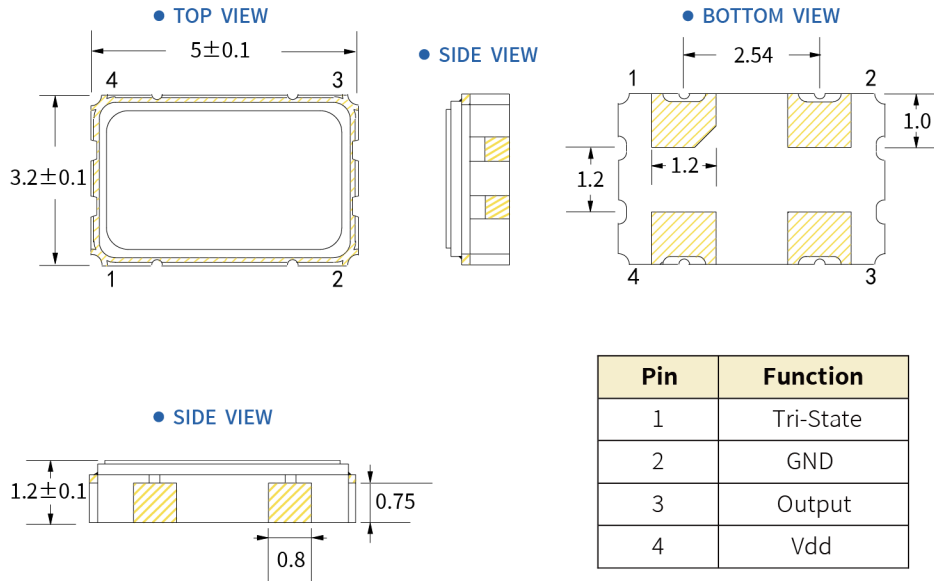

Solder pad layout (UNIT:mm)

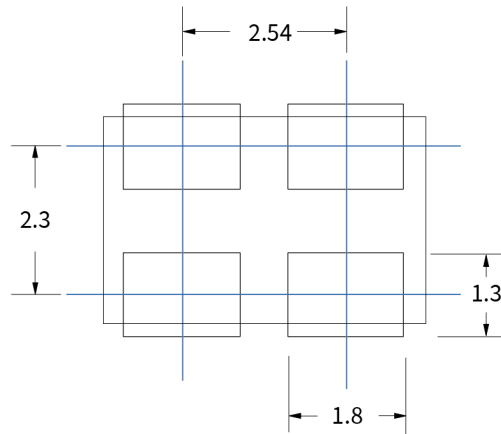

Options and Part Identification : Example SX5M1.000M20F30TNN

Company	Ceramic Package	Frequency Code [MHz]	Supply Voltage	Frequency Tolerance	Operating Temperature	Frequency Drift	Output	Current Consumption	Phase Noise
SX	5M	X.XXX	M	20	F	30	T	N	N
Code Company	Code Ceramic Package	Frequency	Code Voltage	Code Frequency Tolerance	Code Operating Temperature	Code Frequency Drift	Code Output	Code Current	Code Phase Noise
SX SCTF	7M 7.0×5.0×1.3mm 5M 5.0×3.2×1.2mm 3M 3.2×2.5×0.95mm 2M 2.5×2.0×0.81mm 1M 2.0×1.6×0.75mm	1.000 13.560 19.200 37.125	M 1.62V-3.63V	10 ±10ppm 20 ±20ppm	E -20°C ~ +70°C F -40°C ~ +85°C	15 ±15ppm 20 ±20ppm 30 ±30ppm	T Squarewave	N Standard	N Standard

If you have other parameter requirements, you can contact **SCTF** at any time.

5CM Series 5.0 x 3.2 mm SMD Crystal Oscillator

5 : 5.0×3.2×1.2 mm | SMD5032-4P

C : SPXO Crystal Oscillator

M : Multi Voltage

Frequency Temperature Characteristics

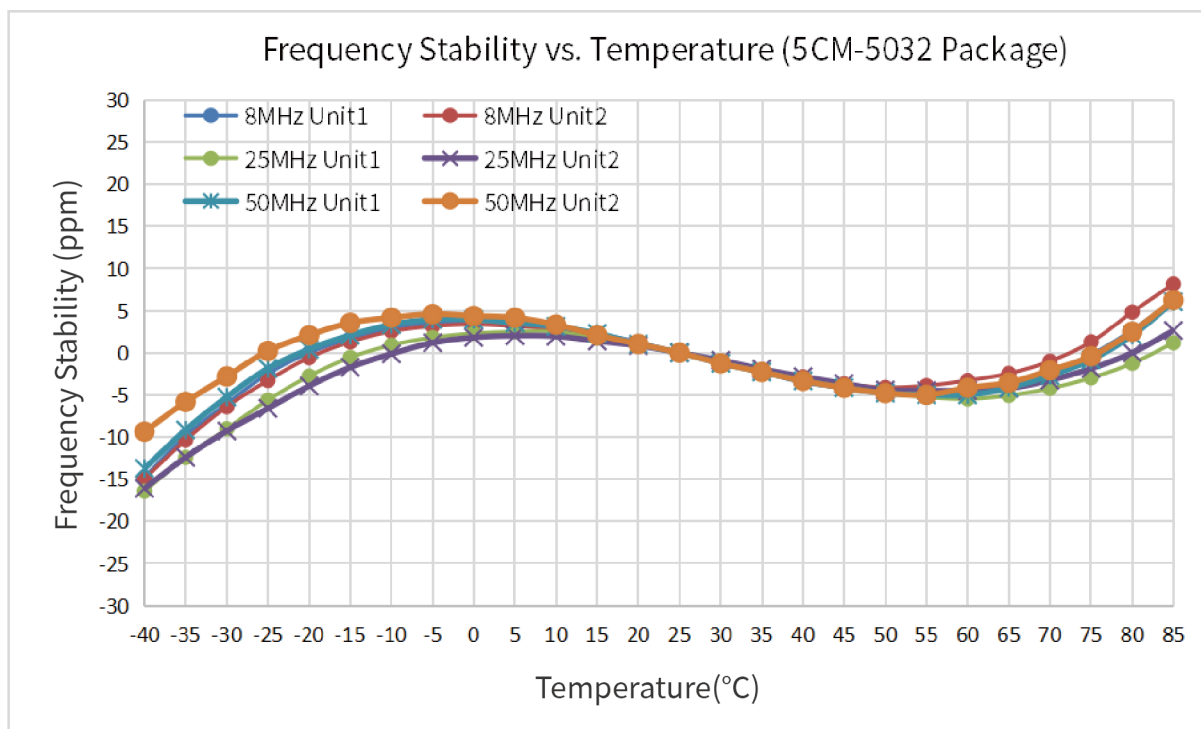

Product Structure & Marking Information

Product Structure

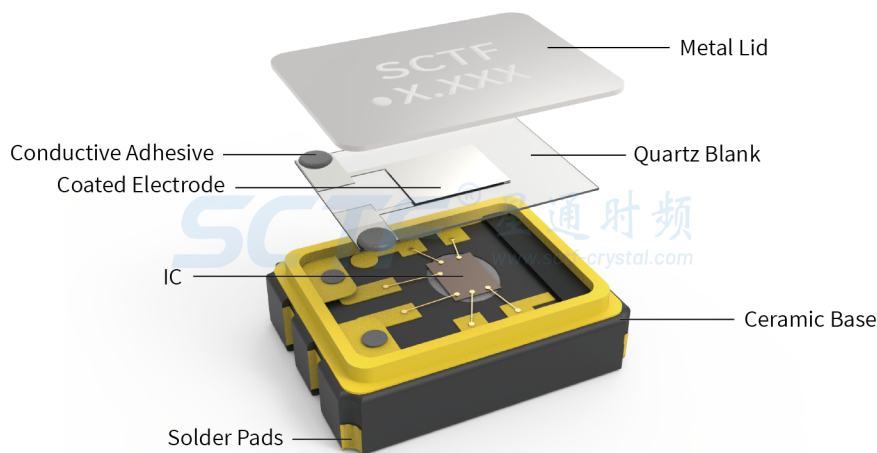

Marking Information

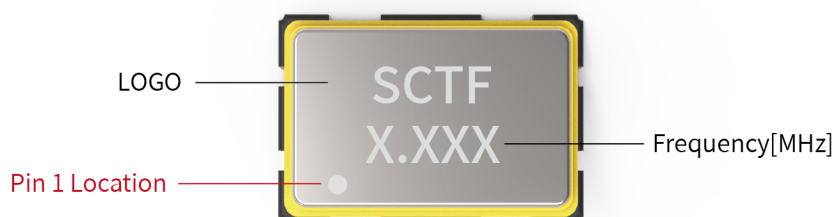

5CM Series 5.0 x 3.2 mm SMD Crystal Oscillator

S : 5.0×3.2×1.2 mm | SMD5032-4P

C : SPXO Crystal Oscillator

M : Multi Voltage

Suggested Reflow Profile

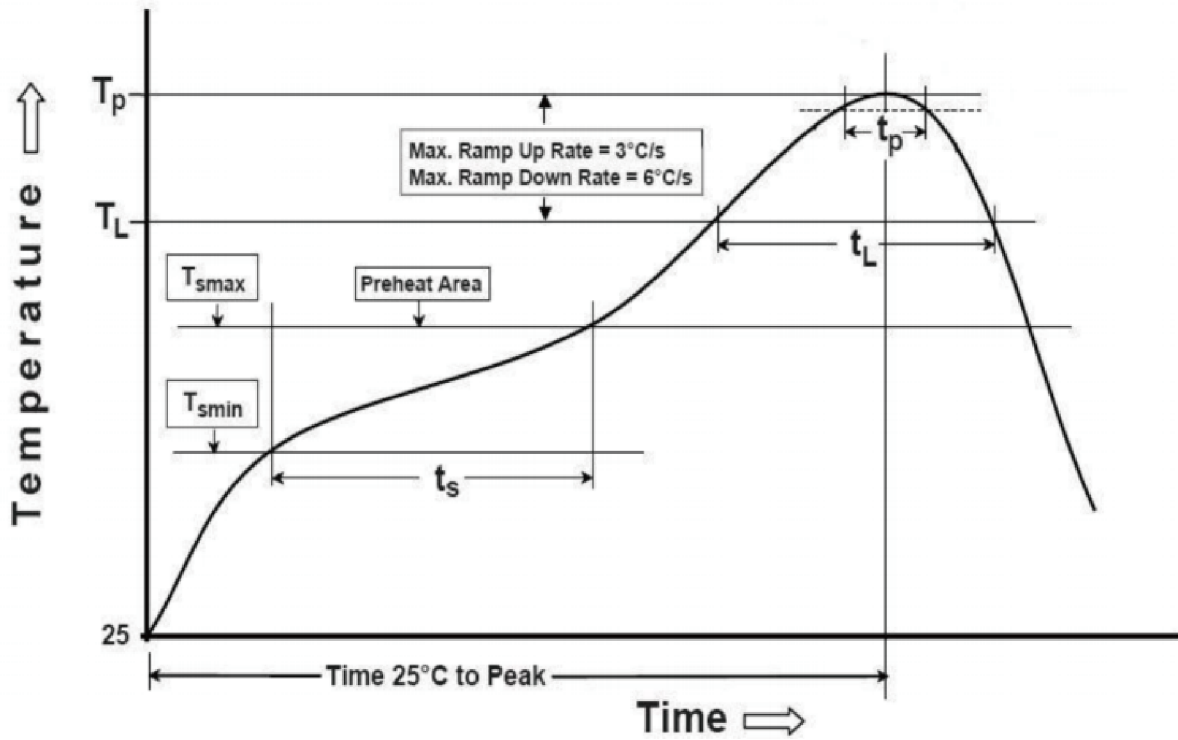

Profile Feature	Sn - Pb Eutectic Assembly	Preheat / Soak
Preheat / Soak <ul style="list-style-type: none"> ● Temperature Min (Ts min) ● Temperature Max (Ts max) ● Time (Ts min to Ts max) 	100°C 150°C 60-120 seconds	150°C 200°C 60-120 seconds
Ramp - up rate (TL to Tp)	3°C/ second max.	3°C/ second max.
Time maintained above <ul style="list-style-type: none"> ● Liquidous temperature (TL) ● Time (tL) maintained above TL 	183°C 60-150 seconds	217°C 60-150 seconds
Peak package body temperature (Tp)	235°C	260°C
Time within 5° C of the specified classification temperature (Tp)	20 seconds	30 seconds
Ramp - down rate (Tp to TL)	6°C/ second max.	6°C/ second max.
Time 25° C to peak temperature	6 minutes max.	8 minutes max.
Suggest reflow times	2 Times max.	

5CM Series 5.0 x 3.2 mm SMD Crystal Oscillator

5 : 5.0×3.2×1.2 mm | SMD5032-4P

C : SPXO Crystal Oscillator

M : Multi Voltage

Testing Circuit

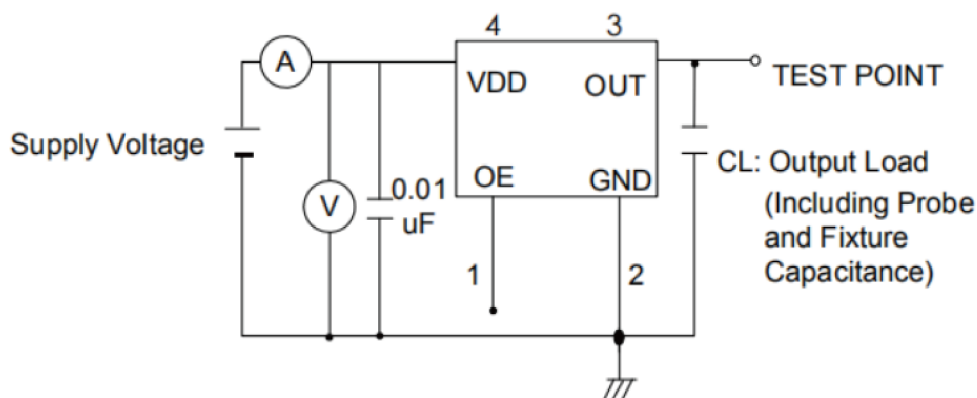

※ Notes: PIN 1 connected to Vdd or floating, the product is working properly; connected to GND, stops working.

Waveform Conditions

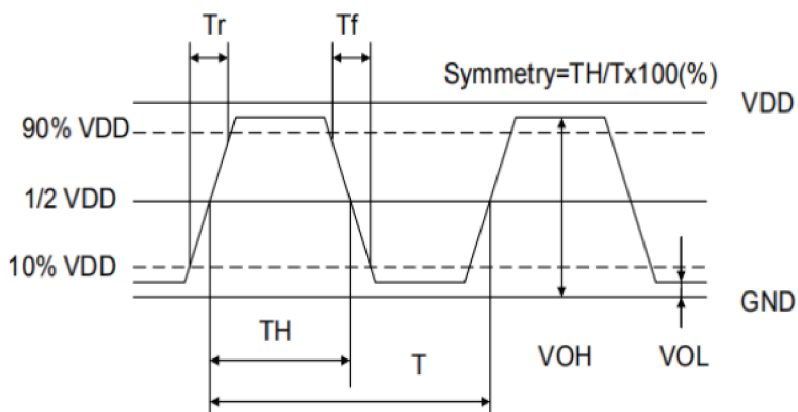

Waveform measurement system should have a min. bandwidth of 5 times the frequency being tested.

5CM Series 5.0 x 3.2 mm SMD Crystal Oscillator

5 : 5.0×3.2×1.2 mm | SMD5032-4P

C : SPXO Crystal Oscillator

M : Multi Voltage

Packaging Information

T=Tape and reel (1,000pcs/reel)

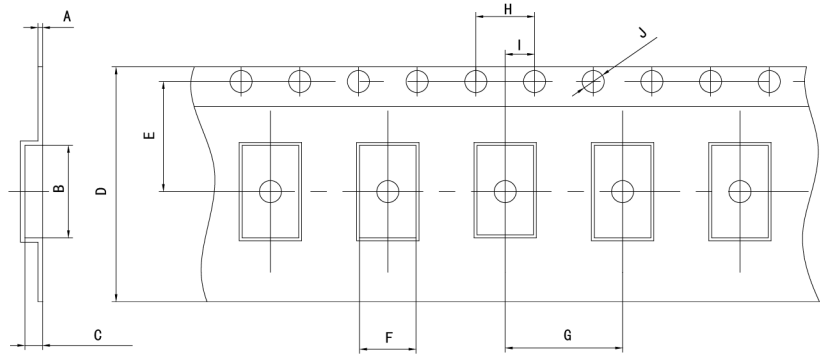
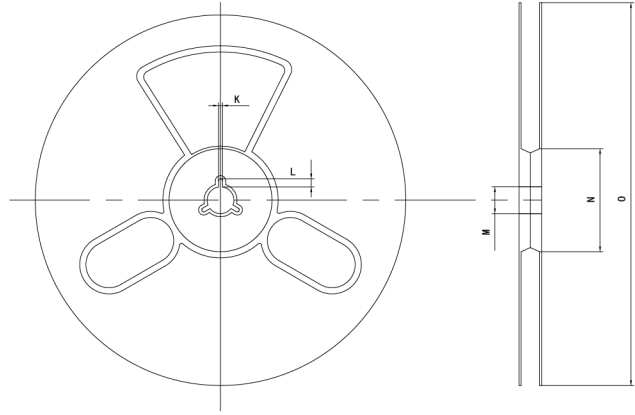

Pocket Tape Dimensions(mm)

Series	A	B	C	D	E	F	G	H	I	J	K	L	M	N	O
5CM	0.3±0.05	5.5±0.1	1.25±0.1	12±0.1	5.5±0.1	3.6±0.1	8.0±0.1	4.0±0.1	2.0±0.1	φ1.5±0.1	2.0±0.2	4.0±1.0	φ13±0.5	φ60±1	φ180±1

5CM Series 5.0 x 3.2 mm SMD Crystal Oscillator

5 : 5.0×3.2×1.2 mm | SMD5032-4P

C : SPXO Crystal Oscillator

M : Multi Voltage

Common Frequencies – MHz

5CM Series				
1.000	1.8432	2.000	2.048	2.4576
2.500	3.2768	3.579545	3.6864	4.000
4.096	4.9152	5.5296	6.000	6.144
7.3728	8.000	8.192	10.000	11.0592
11.2896	12.000	12.288	13.560	14.31818
14.7456	16.000	16.384	18.432	19.200
20.000	20.480	22.1184	22.5792	24.000
24.576	25.000	25.000625	25.175	26.000
27.000	27.120	28.63636	29.4912	30.000
32.000	32.768	33.000	33.330	33.333
33.3333	36.000	36.864	37.125	38.400
40.000	40.680	45.1584	48.000	49.152
50.000	54.000			

X-ON Electronics

Largest Supplier of Electrical and Electronic Components

Click to view similar products for [Standard Clock Oscillators](#) category:

Click to view products by [SCTF](#) manufacturer:

Other Similar products are found below :

[F335-25](#) [F535L-33.333](#) [F535L-50](#) [NBXHBA019LN1TAG](#) [SiT1602BI-22-33E-50.000000E](#) [SIT8918AA-11-33S-50.000000G](#) [SM4420TEV-40.0M-T1K](#) [F335-24](#) [F335-40](#) [F535L-10](#) [F535L-12](#) [F535L-24](#) [F535L-27](#) [PE7744DW-100.0M](#) [ASF1-3.686MHZ-N-K-S](#) [ASV-4.000MHZ-LCS-T](#) [XO57CTECNA3M6864](#) [601251](#) [SiT8503AI-18-33E-0.200000X](#) [SIT9122AI2C233E300.000000X](#) [9120AC-2D2-33E212.500000](#) [9102AI-243N25E100.00000](#) [8208AC-82-18E-25.00000](#) [8008AI-72-XXE-24.545454E](#) [8004AC-13-33E-133.33000X](#) [AS-4.9152-16-SMD-TR](#) [ASFL1-48.000MHZ-LC-T](#) [632L3I004M00000](#) [SIT8920AM-31-33E-25.0000](#) [DSC1028DI2-019.2000](#) [9121AC-2C3-25E100.00000](#) [9102AI-233N33E100.00000X](#) [9102AI-233N25E200.00000](#) [9102AI-232H25S125.00000](#) [9102AI-133N25E200.00000](#) [9102AC-283N25E200.00000](#) [9001AC-33-33E1-30.000](#) [8103AC-13-33E-12.00000X](#) [3921AI-2CF-33NZ125.000000](#) [5730-1SF](#) [XUN736000.032768I](#) [ASV-25.000MHZ-ECS-50-T](#) [EC3925ETTTS-100.000M TR](#) [SIT1602BC-83-33E-10.000000Y](#) [8003AI-12-33S-40.00000Y](#) [1602BI-13-33S-19.200000E](#) [8208AI-2F-18E-25.000000X](#) [8103AI-83-33E-33.00000X](#) [8208AI-8F-33E-66.666666X](#) [NX7031E0125.000000](#)