

编号	SCTF202305693
日期	2023/5/16
版本	B01



承认书

SPECIFICATION FOR APPROVAL

客户名称 Customer Name	:	立创商城
供应商物料名称 Part Name	:	差分输出石英晶体振荡器
产品描述 Description	:	SMD7050 100.000MHz/3.3V/HCSL
供应商物料料号 Part NO.	:	SX7DF100.000B20F30HNN
供应商名称 Supplier Name	:	深圳市星通时频电子有限公司

PLEASE CONFIRM OUR SPECIFICATION。 敬请确认规格书之内容。

CUSTOMER APPROVAL 客户审批		
物料代号 PART NO. _____		
使用于机型 USED IN MODEL: _____		
工程部	品质部	采购部

(敬请承认后返回一份, 谢谢!)

SUPPLIER APPROVAL 供应商审批		
DGN.制表人	CKD. 校对	APPD. 审核、签章
吴丽红	李霞	胡华才

地址: 深圳市南山区龙珠四路方大城T2栋10楼

Add: 10 / F, Building T2, Fangdacheng, Longzhu 4th Road, Nanshan District, Shenzhen, China.

Website: www.sctf-crystal.com

Email: info@sctf-crystal.com

TEL: 0755-86097430

FAX: 0755-86097259

Page : 1



ROHS Compliant

Rev.	Revise page 修订页	Revise Contents 修订内容	Rev. Date 修订日期	Reviser 修订人
B01	N/A	Initial released	2021/2/24	Martin.Hu

SHENZHEN SCTF ELECTRONICS CO., LTD		
DATE	Specification of differential output oscillator 差分输出石英晶体振荡器规格书	Page:
2023/5/16	P/N: SX7DF100.000B20F30HNN Spec.NO.: SCTF202305693	2

■ Electrical Specification 电气参数

No.	Item	Electrical Spec.	Notes
1	Holder Type 封装	SMD7050	
2	Nominal Frequency 标称频率	100.000000 MHz	
3	Frequency Stability 常温频差	±20ppm	at 25°C ±2°C
4	Temperature Drift 温度频差	±30ppm	at - 40°C ~+85 °C
5	Operating Voltage 工作电压	3.3V	± 5% max.
6	Output 输出模式	HCSL	
7	Output Load 输出负载	50Ω	
8	Current Consumption 消耗电流	50 mA Max.	at maximum supply voltage
9	Operating Temperature Range 工作温度范围	-40°C ~ +85°C	
10	Storage Temperature Range 存储温度范围	-55°C ~ +125°C	
11	Duty Cycle 占空比	45% ~ 55%	
12	Rise / Fall Time 上升/下降沿时间	1 nS Max.	20~80% Vdd
13	High Output Voltage 高电平	0.66V Min.	
14	Low Output Voltage 低电平	0.15V Max.	
15	Start-up Time 起振时间	10 mS Max.	to 90% of final amplitude
16	Phase Noise 相位噪声	-120dBc/Hz Max.	at 1KHz offset
17	RMS Phase Jitter 均方根抖动	0.5pSec Max.	Period Jitter(12KHz-20MHz)
18	Enable Voltage High (Logic 1) 使能高电平	70%Vdd Min.	Pin 1 Tri-state Outputs will be enable if OE is Logic 1 or open; Outputs will be disable if OE is Logic 0.
19	Enable Voltage Low (Logic 0) 使能低电平	30%Vdd Max.	输出使能OE是高电平1或者悬空,频率输出; 输出使能OE是低电平0,则无频率输出.
20	Aging 老化	±3ppm	1st. Year at 25°C

SHENZHEN SCTF ELECTRONICS CO., LTD

DATE	Specification of differential output oscillator 差分输出石英晶体振荡器规格书	Page:
2023/5/16	P/N: SX7DF100.000B20F30HNN Spec.NO.: SCTF202305693	3

■ DIMENSIONS 产品尺寸

Units (单位): mm(毫米)

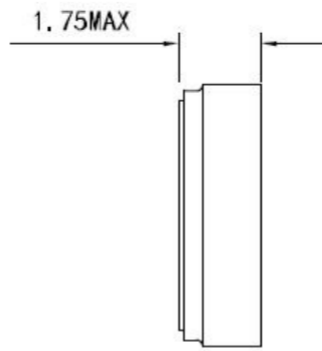
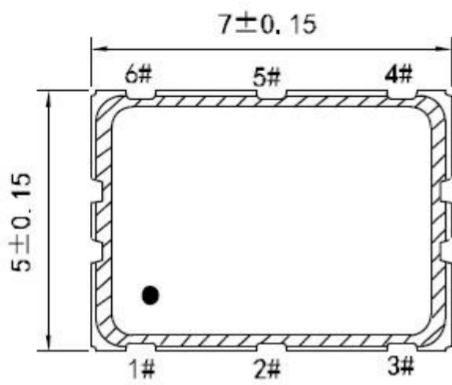

Pad Functions:

1. EN
2. NC
3. GND
4. Output
5. Comp. Output
6. Vdd

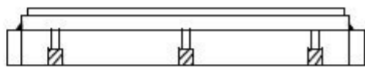

■ Pad size 焊盘尺寸

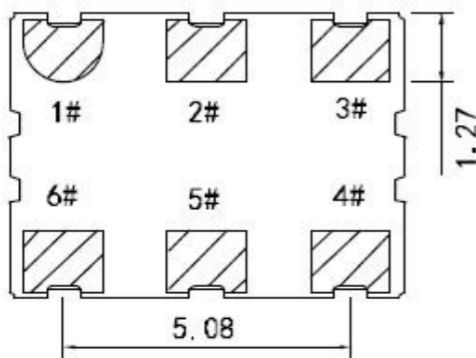

Bottom View

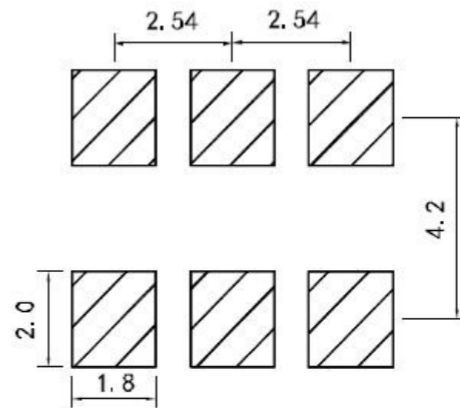

Suggested solder pad layout

■ TESTING CIRCUIT 测试电路

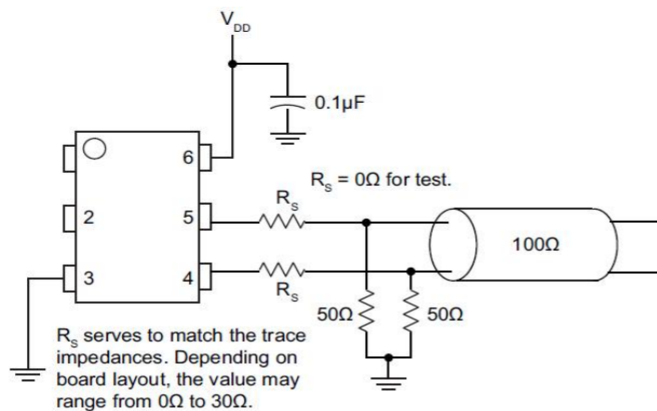

※ Notes: PIN 1 connected to Vdd or floating, the product is working properly; connected to GND, stops working.

SHENZHEN SCTF ELECTRONICS CO., LTD

SHENZHEN SCTF ELECTRONICS CO., LTD		
DATE	Specification of differential output oscillator 差分输出石英晶体振荡器规格书	Page:
2023/5/16	P/N: SX7DF100.000B20F30HNN Spec.NO.: SCTF202305693	4

■ WAVEFORM CONDITIONS 输出波形

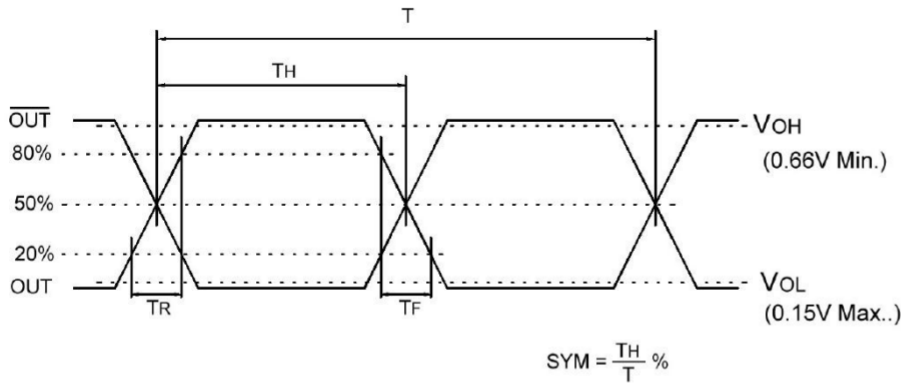

Waveform measurement system should have a min. bandwidth of 5 times the frequency being tested.

■ Product Structure 产品结构

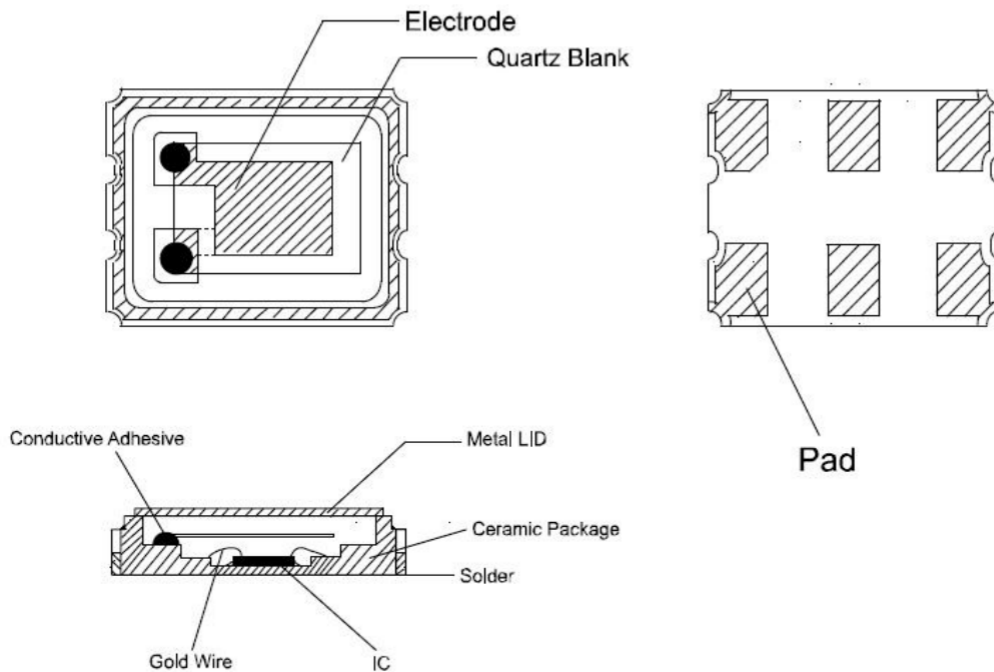

■ Marking 印字

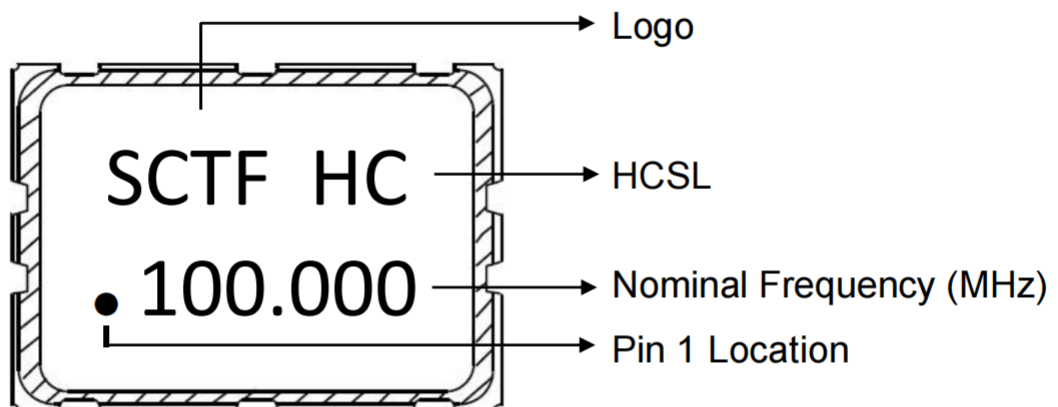

SHENZHEN SCTF ELECTRONICS CO., LTD		
DATE	Specification of differential output oscillator 差分输出石英晶体振荡器规格书	Page:
2023/5/16	P/N: SX7DF100.000B20F30HNN Spec.NO.: SCTF202305693	5

REFLOW PROFILES 回流焊条件

Profile Feature	Sn-Pb Eutectic Assembly	Pb-Free Assembly
Preheat/Soak		
● Temperature Min(T_s min)	100 °C	150 °C
● Temperature Max (T_s max)	150 °C	200 °C
● Time (T_s min to T_s max)	60-120 seconds	60-120 seconds
Ramp-up rate (TL to T_p)	3 °C/second max.	3 °C/second max.
Time maintained above		
● Liquidous temperature (TL)	183 °C	217 °C
● Time (TL) maintained above TL	60-150 seconds	60-150 seconds
Peak package body temperature (T_p)	235 °C	260 °C
Time within 5 °C of the specified classification temperature (T_p)	20 seconds	30 seconds
Ramp-down rate (T_p to TL)	6 °C/second max.	6 °C/second max.
Time 25 °C to peak temperature	6 minutes max.	8 minutes max.
Suggest reflow times	2 Times max.	

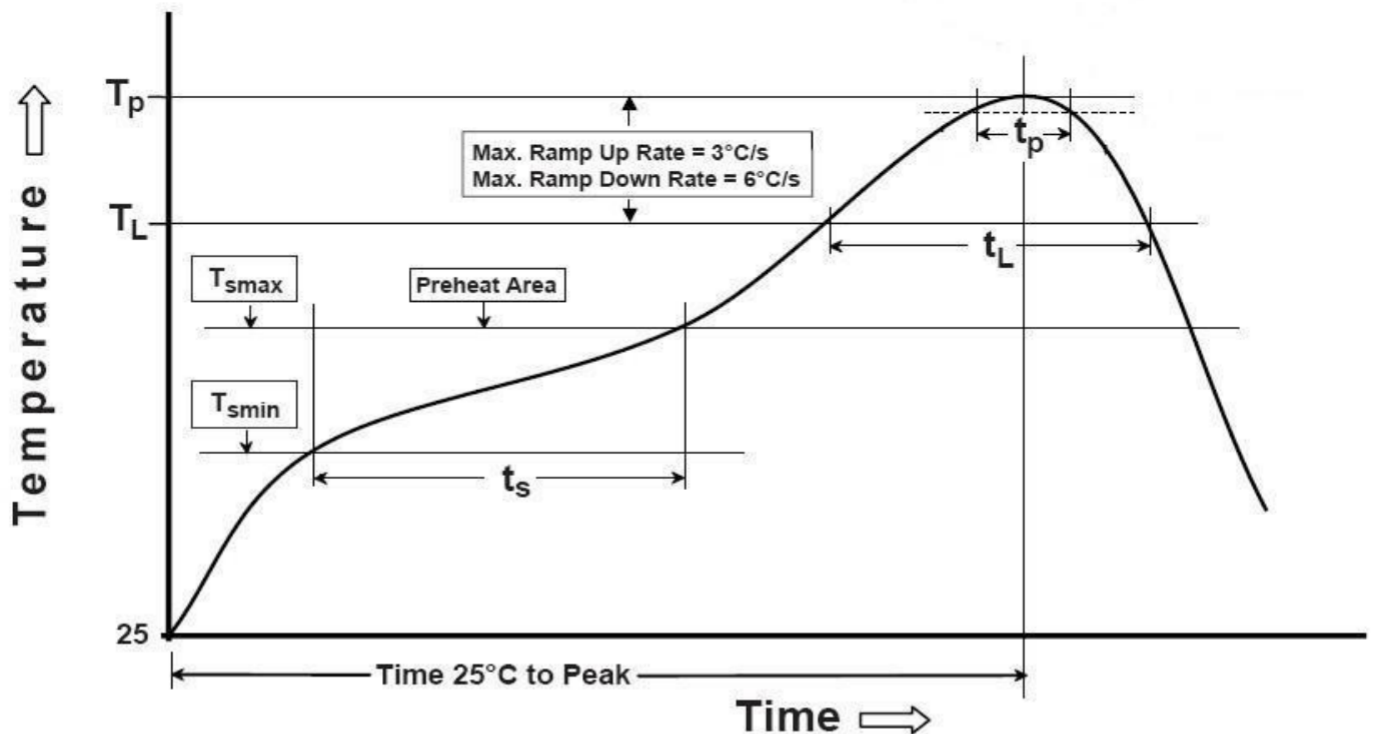

SHENZHEN SCTF ELECTRONICS CO., LTD

DATE	Specification of differential output oscillator 差分输出石英晶体振荡器规格书	Page:
2023/5/16	P/N: SX7DF100.000B20F30HNN Spec.NO.: SCTF202305693	6

■ RELIABILITY SPECIFICATION 可靠性参数

No.	项目 ITEM	条件 CONDITIONS	合格标准 BASIS OF VERDICT
1	跌落 DROP	100cm高处自由跌落到3cm厚木板上,3次 High: 100cm; Thickness: 3cm; 3 times.	$\Delta FL \leq \pm 5 \text{ppm}$
2	振动 VIBRATION	频率 Frequency: 10~57.7Hz; 幅度 Amplitude: $\pm 0.75 \text{mm}$ 频率 Frequency: 57.7Hz~500Hz; 加速度幅度 acceleration rate: 98m/s^2 周期 Cycle time: 10-500-10Hz: 15min 振动方向 Direction: X, Y, Z 振动时间 Duration: 每个方向2小时 2 h/direction.	$\Delta FL \leq \pm 5 \text{ppm}$
3	温度变化 TEMPERATURE SHOCK	$-40^\circ\text{C} \pm 2^\circ\text{C}$ (30min) \leftrightarrow $85^\circ\text{C} \pm 2^\circ\text{C}$ (30min); 循环10次 $-40^\circ\text{C} \pm 2^\circ\text{C}$ (30min) \leftrightarrow $85^\circ\text{C} \pm 2^\circ\text{C}$ (30min); For 10	$\Delta FL \leq \pm 5 \text{ppm}$
4	湿热 HUMIDITY	cycles 温度: $40^\circ\text{C} \pm 2^\circ\text{C}$; 湿度 90-95%; 时间: 96小时 Temp: $40^\circ\text{C} \pm 2^\circ\text{C}$; Humidity: 90-95%; Times: 96h	$\Delta FL \leq \pm 5 \text{ppm}$
5	低温 COLD RESISTANCE	温度: $-40^\circ\text{C} \pm 2^\circ\text{C}$; 时间: 96小时 Temp: $-40^\circ\text{C} \pm 2^\circ\text{C}$; Times: 96h	$\Delta FL \leq \pm 5 \text{ppm}$
6	高温1 HEAT RESISTANCE 1	温度: $100^\circ\text{C} \pm 2^\circ\text{C}$; 时间: 96小时 Temp: $100^\circ\text{C} \pm 2^\circ\text{C}$; Times: 96h	$\Delta FL \leq \pm 5 \text{ppm}$
7	高温2 HEAT RESISTANCE 2	温度: $155^\circ\text{C} \pm 2^\circ\text{C}$; 时间: 2小时 Temp: $155^\circ\text{C} \pm 2^\circ\text{C}$; Times: 2h	$\Delta FL \leq \pm 5 \text{ppm}$
8	高温3 HEAT RESISTANCE 3	温度: $85^\circ\text{C} \pm 2^\circ\text{C}$; 电压: 3.3V/5.0V; 时间: 96小时 Temp: $85^\circ\text{C} \pm 2^\circ\text{C}$; Voltage: 3.3V/5.0V; Times: 96h	$\Delta FL \leq \pm 5 \text{ppm}$
9	回流焊 REFLOW	$150^\circ\text{C} \pm 5^\circ\text{C}$ 保持 120s 后升到 $270^\circ\text{C} \pm 5^\circ\text{C}$ 保持 10s, 升温 and 保温时间小于 200s, 常温放置 1~2h 后测定 Keep $150^\circ\text{C} \pm 5^\circ\text{C}$ 120s and then rose to $270^\circ\text{C} \pm 5^\circ\text{C}$ for 10s, warming and holding time is less than the 200s, placed at room temperature 1 ~ 2h after test	$\Delta FL \leq \pm 5 \text{ppm}$
10	盐雾 SALT SPRAY	盐雾浓度: 5%; 温度: 35°C ; 时间: 24小时 Salt density: 5%; Temp: 35°C ; Times: 24h	目测无明显腐蚀现象 Visual no significant corrosion
11	老化 AGING	温度: 85°C ; 时间: 30天 Temp: 85°C ; Times: 30days	$\Delta FL \leq \pm 5 \text{ppm}$
12	气密性 LEAKAGE	氦气 (0.6~0.65MPa): 10分钟 He (0.6~0.65MPa): 10min	$\leq 3 \times 10^{-9} \text{Pa} \cdot \text{m}^3/\text{s}$
13	焊接 SOLDER	温度: $260^\circ\text{C} \pm 5^\circ\text{C}$ Temp: $260^\circ\text{C} \pm 5^\circ\text{C}$	浸锡率大于 90% Soldering tin rate greater than 90%

SHENZHEN SCTF ELECTRONICS CO., LTD

DATE	Specification of differential output oscillator 差分输出石英晶体振荡器规格书	Page:
2023/5/16	P/N: SX7DF100.000B20F30HNN Spec.NO.: SCTF202305693	7

■ Taping Specifications 编带规格

UNIT(单位):mm(毫米)

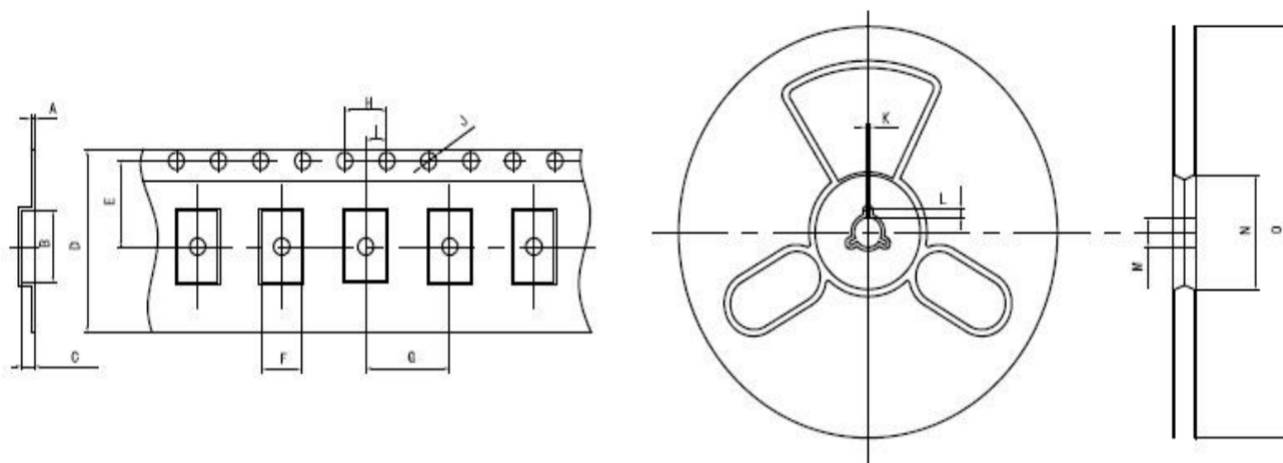

TEVE	A	B	C	D	E	F	G	H	I	J	K	L	M	N	O
5×7 SMD	0.3	7.5	2.0	16.0	7.5	5.5	8.0	4.0	2.0	1.5	2.0	4.0	13.0	60.0	180.0

■ Packaging specifications 包装规格

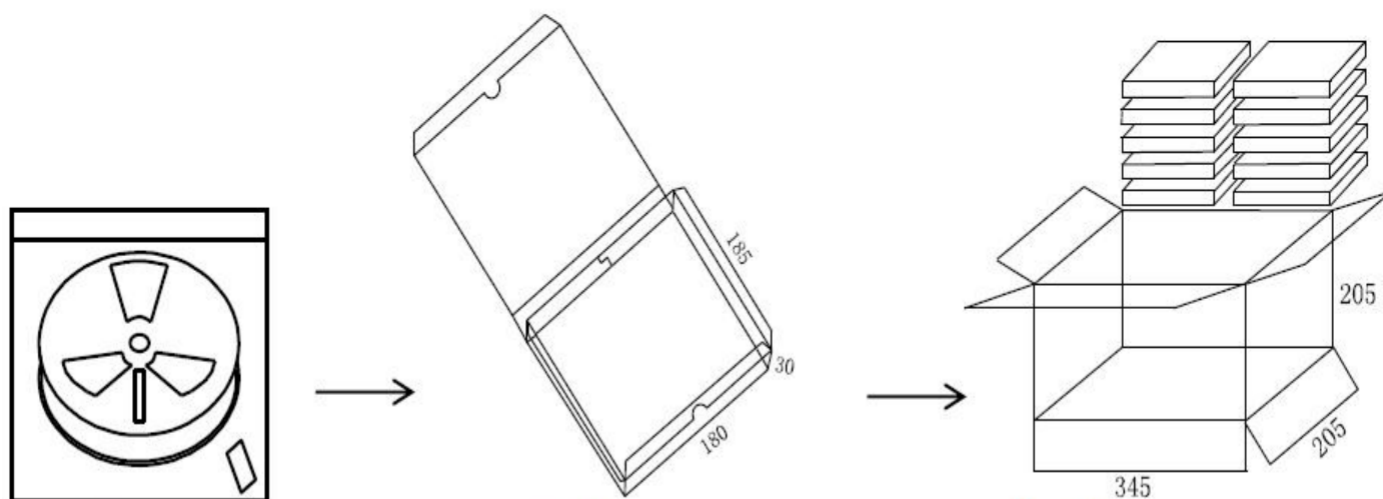

自封袋 (Bag)
1000只 = 1 轮
1000pcs = 1 Reel

内包装 (Inside package)
1 轮=1 盒
1 Reel=1 box

外包装 (Outside Package)
10 盒=1 箱
10 box=1 carton

SHENZHEN SCTF ELECTRONICS CO., LTD

DATE	Specification of differential output oscillator 差分输出石英晶体振荡器规格书	Page:
2023/5/16	P/N: SX7DF100.000B20F30HNN Spec.NO.: SCTF202305693	8

X-ON Electronics

Largest Supplier of Electrical and Electronic Components

Click to view similar products for [Standard Clock Oscillators](#) category:

Click to view products by [SCTF](#) manufacturer:

Other Similar products are found below :

[601252](#) [F335-25](#) [F535L-33.333](#) [F535L-50](#) [NBXHBA019LN1TAG](#) [SiT1602BI-22-33E-50.000000E](#) [SiT8209AI-32-33E-125.000000](#)
[SIT8918AA-11-33S-50.000000G](#) [SM4420TEV-40.0M-T1K](#) [F335-24](#) [F335-40](#) [F535L-10](#) [F535L-12](#) [F535L-24](#) [F535L-27](#) [PE7744DW-](#)
[100.0M](#) [ASF1-3.686MHZ-N-K-S](#) [ASV-4.000MHZ-LCS-T](#) [XLH735025.000JU4I8](#) [XLP725125.000JU6I8](#) [XO57CTECNA3M6864](#) [601251](#)
[SiT8503AI-18-33E-0.200000X](#) [SIT8918AA-11-33S-16.000000G](#) [SIT9122AI2C233E300.000000X](#) [XO37CTECNA20M](#) [9120AC-2D2-](#)
[33E212.500000](#) [9102AI-243N25E100.000000](#) [8208AC-82-18E-25.000000](#) [8008AI-72-XXE-24.545454E](#) [8004AC-13-33E-133.33000X](#) [AS-](#)
[4.9152-16-SMD-TR](#) [ASFL1-48.000MHZ-LC-T](#) [632L3I004M00000](#) [SIT8920AM-31-33E-25.0000](#) [9121AC-2C3-25E100.000000](#) [9102AI-](#)
[233N33E100.00000X](#) [9102AI-233N25E200.000000](#) [9102AI-232H25S125.000000](#) [9102AI-133N25E200.000000](#) [9102AC-283N25E200.000000](#)
[9001AC-33-33E1-30.0000](#) [8103AC-13-33E-12.00000X](#) [3921AI-2CF-33NZ125.000000](#) [5730-1SF](#) [XUN736000.032768I](#) [EC3925ETTTTS-](#)
[100.000M TR](#) [SIT1602BC-83-33E-10.000000Y](#) [8003AI-12-33S-40.00000Y](#) [1602BI-13-33S-19.200000E](#)