

7VA Series 7.0 x 5.0 mm SMD Crystal Oscillator

7 : 7.0×5.0×1.45 mm | SMD7050-6P

VA : VCXO Crystal Oscillator [6PAD]

Feature

- Ceramic surface mount with Metal Lid
- Wide Absolute pulling range: ±50ppm min.
- CMOS compatible logic levels
- RoHS Compliant / Pb Free

Applications

- Networking, SONET/SDH
- Direct Digital Synthesis (DDS)
- DSL/ADSL
- Base Terminal Stations



Electrical Specifications

Item	Symb.	Min.	Typ.	Max.	Unit	Notes
Frequency Range	Freq.	2.048		54.000	MHz	
Operating Temperature	T_use	-20		+70	°C	
		-40		+85	°C	
Storage Temperature Range	T_stg	-55		+125	°C	
Supply Voltage	Vdd	2.97	3.3	3.63	V	
Output Load	L_CMOS		15		pF	
Current Consumption	Icc			10	mA	2.4MHz ≤ Freq. < 36MHz
				15		36MHz ≤ Freq. < 54MHz
Absolute Pull Range	APR	±50			ppm	
Center Voltage	Vcont		1.65		V	
Control Voltage Range	Vc	0.3		3.0	V	
Linearity	L			10	%	
Modulation Band Width	MBW	15			KHz	
VC Input Impedance	Rin	5			MΩ	
Duty Cycle	SYM	45		55	%	50 % Vdd level, L_CMOS ≤ 15 pF
High output voltage	VoH	0.9Vdd			V	
Low output voltage	VoL			0.1Vdd	V	
Enable Voltage High(Logic 1)	VIH	0.7Vdd			V	Output will be disable if OE is Logic 0 Output will be enable if OE is Logic 1 or open
Enable Voltage Low(Logic 0)	VIL			0.3Vdd	V	
Rise / Fall Time	TR/TF			5	nS	10% Vdd to 90% Level
Start-up Time	T_str			2	mS	To 90% of Final Amplitude
Aging	f_age			3	ppm	1st. Year at 25°C

Frequency Stability & Operating Temperature Range

Temp.	FT	±25ppm	±50ppm
	-20°C to +70°C	★	★
-40°C to +85°C	△		★

★: Available △: Conditional

All condition: Include 25°C tolerance, operating temperature range, input voltage change, aging, load change.

7VA Series 7.0 x 5.0 mm SMD Crystal Oscillator

7 : 7.0×5.0×1.45 mm | SMD7050-6P

VA : VCXO Crystal Oscillator [6PAD]

Dimensions (UNIT:mm)

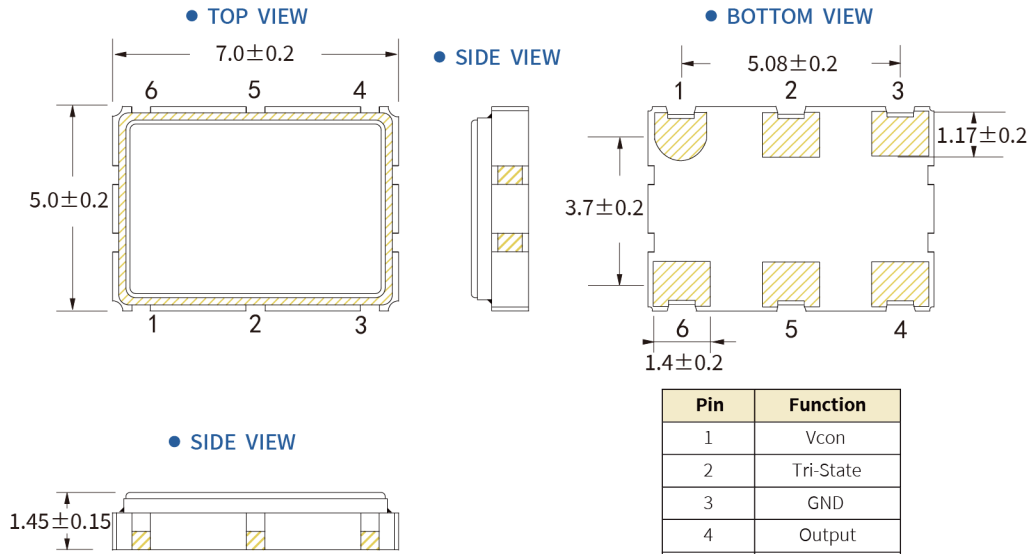

Solder pad layout (UNIT:mm)

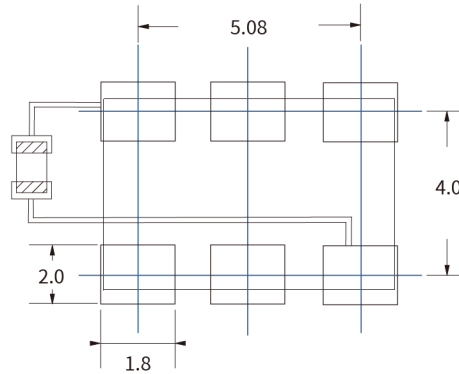

To ensure optimal oscillator performance, place a by-pass capacitor of 0.1μF as close to the part as possible between Vdd and GND pads.

Options and Part Identification : Example SX7V10.000B20050F30TNNS

Company	Ceramic Package	Frequency Code [MHz]	Supply Voltage	Frequency Tolerance	Pullability	Operating Temperature	Frequency Drift	Output Symetry	Output Level	Phase Noise	PAD
SX	7V	X.XXX	B	20	050	F	30	T	N	N	S
Code Company	Code Ceramic Package	Frequency	Code Voltage	Code Frequency Tolerance	Code Pullability	Code Operating Temperature	Code Frequency Drift	Code Output Symetry	Code Output Level	Code Phase Noise	Code PAD
SX SCTF	7V 7.0×5.0×1.3mm 5V 5.0×3.2×1.2mm 3V 3.2×2.5×0.95mm	10.000	B 3.3V	10 ±10ppm 20 ±20ppm	050 ±50ppm 070 ±70ppm 085 ±85ppm 100 ±100ppm	E -20°C ~ +70°C F -40°C ~ +85°C	15 ±15ppm 20 ±20ppm 30 ±30ppm	T Squarewave	N CMOS	N Standard	Blank 4PAD S 6PAD

If you have other parameter requirements, you can contact **SCTF** at any time.

7VA Series 7.0 x 5.0 mm SMD Crystal Oscillator

7 : 7.0×5.0×1.45 mm | SMD7050-6P

VA : VCXO Crystal Oscillator [6PAD]

Frequency Temperature Characteristics

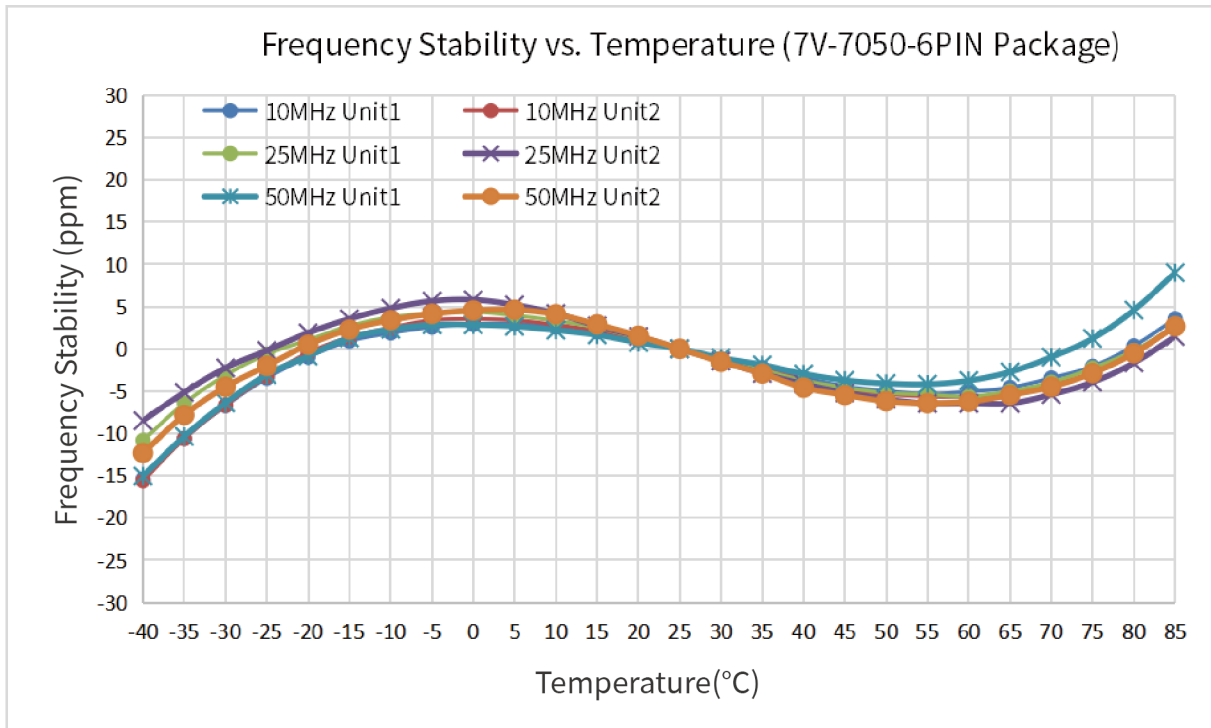

Product Structure & Marking Information

Product Structure

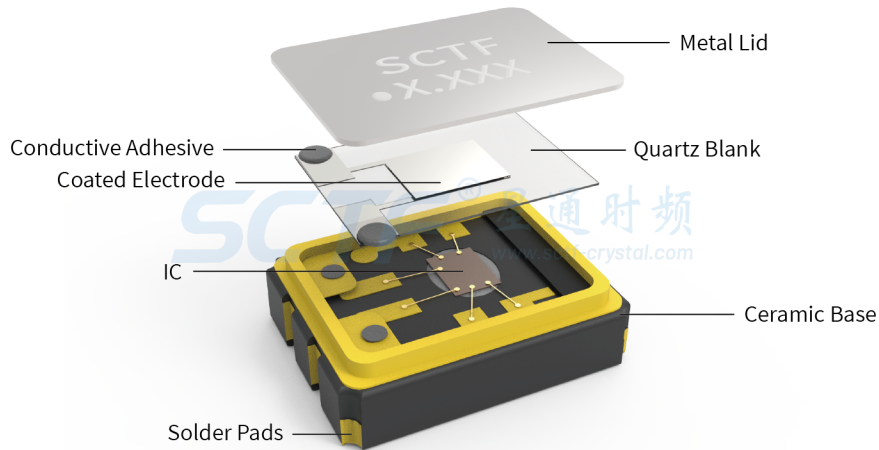

Marking Information

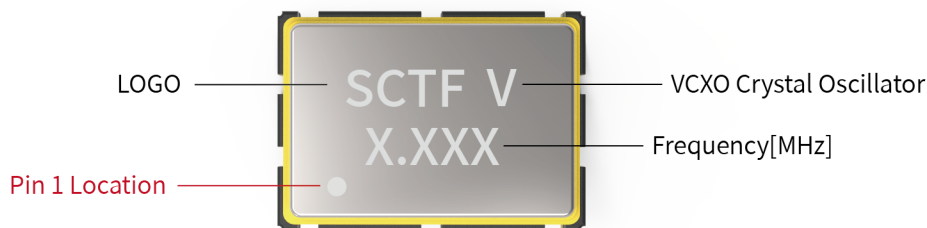

7VA Series 7.0 x 5.0 mm SMD Crystal Oscillator

7 : 7.0×5.0×1.45 mm | SMD7050-6P

VA : VCXO Crystal Oscillator [6PAD]

Suggested Reflow Profile

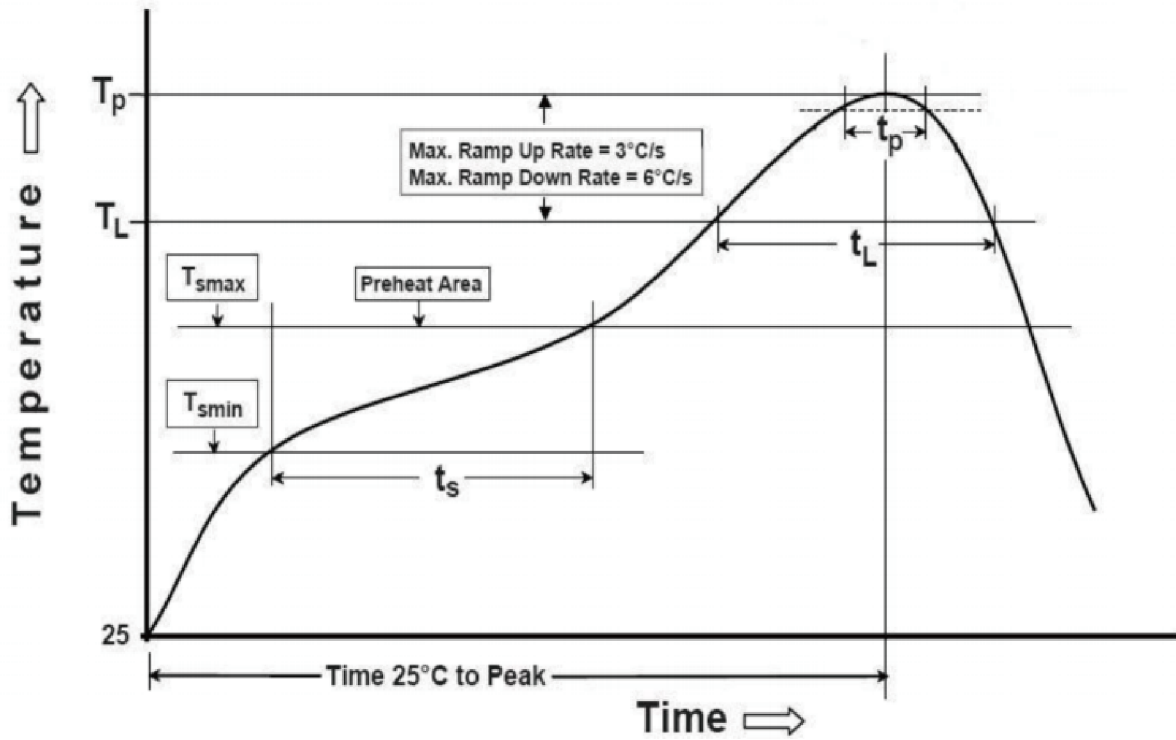

Profile Feature	Sn - Pb Eutectic Assembly	Preheat / Soak
Preheat / Soak <ul style="list-style-type: none"> ● Temperature Min (Ts min) ● Temperature Max (Ts max) ● Time (Ts min to Ts max) 	100°C 150°C 60-120 seconds	150°C 200°C 60-120 seconds
Ramp - up rate (TL to Tp)	3°C/ second max.	3°C/ second max.
Time maintained above <ul style="list-style-type: none"> ● Liquidous temperature (TL) ● Time (tL) maintained above TL 	183°C 60-150 seconds	217°C 60-150 seconds
Peak package body temperature (Tp)	235°C	260°C
Time within 5° C of the specified classification temperature (Tp)	20 seconds	30 seconds
Ramp - down rate (Tp to TL)	6°C/ second max.	6°C/ second max.
Time 25° C to peak temperature	6 minutes max.	8 minutes max.
Suggest reflow times	2 Times max.	

7VA Series 7.0 x 5.0 mm SMD Crystal Oscillator

7 : 7.0×5.0×1.45 mm | SMD7050-6P

VA : VCXO Crystal Oscillator [6PAD]

Testing Circuit

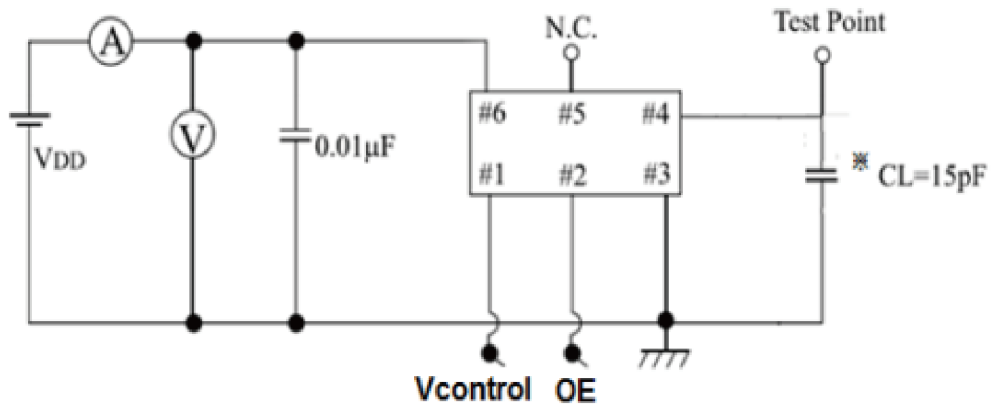

※ Notes: Test point load should include stray and probe capacitance.

Waveform Conditions



Waveform measurement system should have a min. bandwidth of 5 times the frequency being tested.

7VA Series 7.0 x 5.0 mm SMD Crystal Oscillator

7 : 7.0×5.0×1.45 mm | SMD7050-6P

VA : VCXO Crystal Oscillator [6PAD]

Packaging Information

T=Tape and reel (1,000pcs/reel)

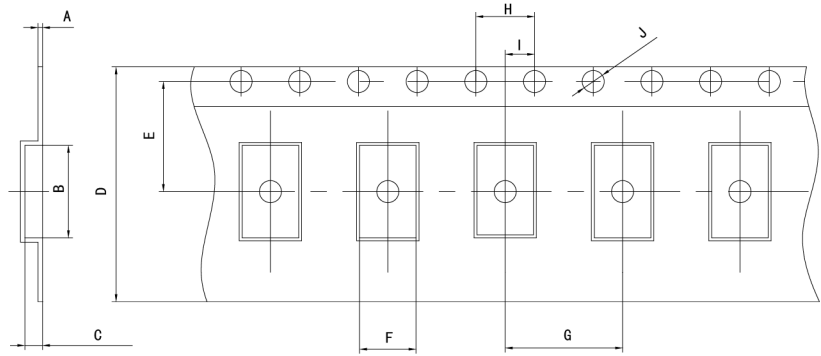
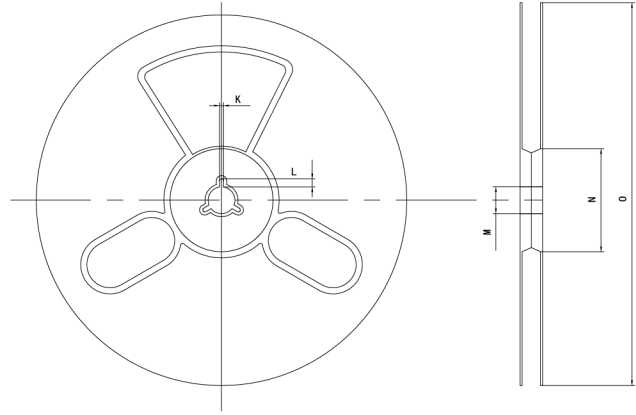

Pocket Tape Dimensions(mm)

Series	A	B	C	D	E	F	G	H	I	J	K	L	M	N	O
7VA	0.3±0.05	7.6±0.1	2.0±0.1	16±0.3	7.5±0.1	5.4±0.1	8.0±0.1	4.0±0.1	2.0±0.1	φ1.5±0.1	2.0±0.2	4.0±1.0	φ13±0.5	φ60±1	φ180±1

Common Frequencies – MHz

7VA Series				
2.048	4.000	4.096	4.9152	6.000
7.3728	7.680	8.000	8.192	10.000
11.0592	11.2896	12.000	12.288	13.000
14.7456	16.000	16.384	18.432	19.200
19.440	20.000	22.5792	24.000	24.576
25.000	26.000	27.000	29.4912	30.000
32.000	32.768	33.000	40.000	45.1584
48.000	49.152	50.000	52.000	54.000

X-ON Electronics

Largest Supplier of Electrical and Electronic Components

Click to view similar products for [VCXO Oscillators](#) category:

Click to view products by [SCTF](#) manufacturer:

Other Similar products are found below :

[3808AI-DF-33NG-80.0000](#) [SIT3808AI-CF-33EM-50.000000X](#) [FRSONT019](#) [SiT3701AC-43-33C-10.00000X](#) [315LB3I1250T](#) [CVPD-922X-100.000](#) [FY3HCJM45.1584-BULK](#) [SiT3807AC-C2-33EB-12.288000Y](#) [NBVSPA015LN1TAG](#) [NBVSPA015LNHTAG](#) [NBVSPA019LNHTAG](#) [NBVSPA024LN1TAG](#) [SX3V24.576B20100F30TNN](#) [SX3V16.384B2070F30TNN](#) [SX3V25.000B20100F30TNN](#) [NV0507DH3I155E030N100](#) [SX3V12.288B20070F30TNNS](#) [SX5V16.384B20100F30TNNS](#) [SX7V20.000B20100F30TNNS](#) [SX3V2.048B20070F30TNN](#) [SX7V10.000B20100F30TNNS](#) [SX7V25.000B20100F30TNNS](#) [SX7V49.152B20100F30TNNS](#) [SX3V49.152B20100F30TNNS](#) [SX7V45.1584B20100F30TNNS](#) [SX3V10.000B20070F30TNNS](#) [SX3V12.288B20070F30TNN](#) [SX5V10.000B20100F30TNNS](#) [SX7V16.384B20100F30TNNS](#) [SX5V12.288B20100F30TNNS](#) [SX7V19.440B20100F30TNNS](#) [SX5V49.152B20100F30TNNS](#) [SX3V45.1584B20100F30TNNS](#) [SX5V50.000B20100F30TNNS](#) [SX5V24.576B20100F30TNNS](#) [SX7V27.000B20100F30TNNS](#) [SX7V32.768B20100F30TNNS](#) [SX3V27.000B20100F30TNNS](#) [SX5V40.000B20100F30TNNS](#) [SX3V32.768B20100F30TNNS](#) [SX3V40.000B20100F30TNNS](#) [SX7V12.288B20100F30TNNS](#) [SX3V24.000B20085F30TNNS](#) [SX3V20.000B20085F30TNNS](#) [SX5V25.000B20100F30TNNS](#) [SX3V10.000B20070F30TNN](#) [SX3V16.384B20070F30TNNS](#) [SX3V19.440B20085F30TNNS](#) [SX5V20.000B20100F30TNNS](#) [SX3V24.576B20100F30TNNS](#)