

ODYSSEY – STM32MP157C

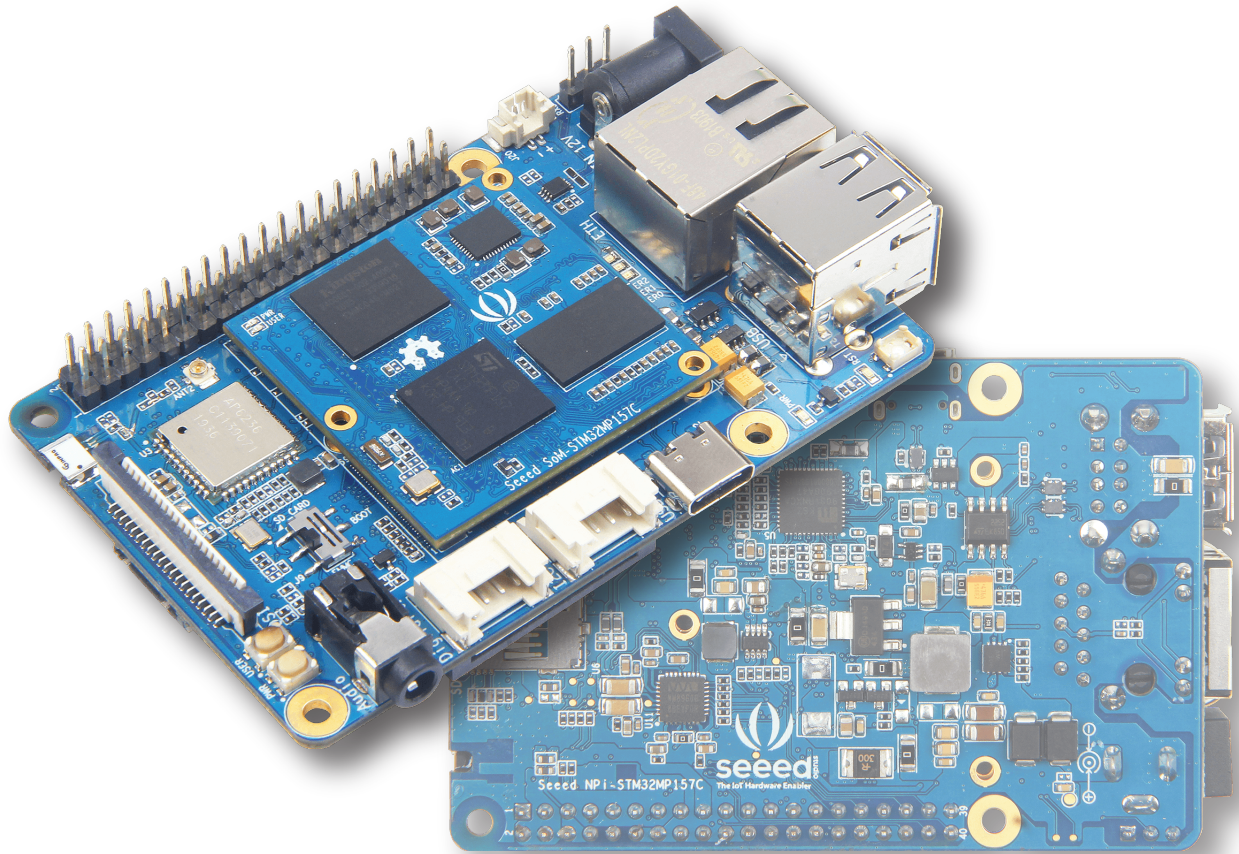

System-On-Module + Carrier Single Board Computer



Reference Guide

Revision A
March 30, 2020

Table of Contents

Overview

Description	3
Features	3
Applications	3

Specifications

SoM-STM32MP157C	4
Carrier Board	4

Hardware Overview

Carrier Board pinout diagram	5
SoM component details	5
Carrier Board component details	6

Overview

Description

The ODYSSEY – STM32MP157C is a single board computer that is based on STM32MP157C, a dual-core Arm® Cortex®-A7 processor operating at 650Mhz. The processor also integrates an Arm® Cortex®-M4 coprocessor, which makes it suitable for real-time tasks. The ODYSSEY – STM32MP157C is created in a form of SoM (System-On-Module) with a carrier board. The SoM consists of an MPU, PMIC, RAM and the carrier board is in Raspberry Pi form factor. The carrier board includes all the necessary peripherals including Gigabit Ethernet, Wi-Fi/BLE, DC Power, USB Hosts, USB-C, MIPI-DSI, DVP for camera, Audio, etc. With this board, customers can evaluate the SoM and deploy the SoM on their own carrier board quickly and easily.

Features

- Dual-Core Arm® Cortex®-A7 Processor with Cortex®-M4 Integrated
- SoM (System-On-Module) includes MPU, PMIC, RAM
- Raspberry Pi 40-Pin Compatible Carrier Board
- Compact Size and Powerful
- Open-Source Hardware/SDK/API/BSP/OS

Applications

- Industrial (CAN-Ethernet gateways)
- White goods (refrigerators, microwaves)
- Medical (data loggers)
- High-end wearables (VR devices)
- Smart Home Devices

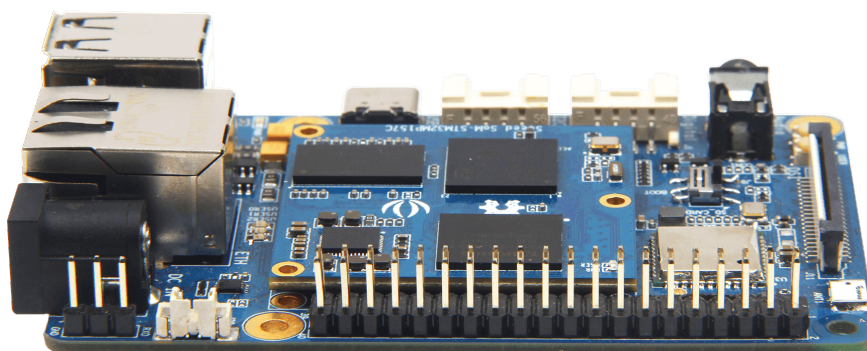
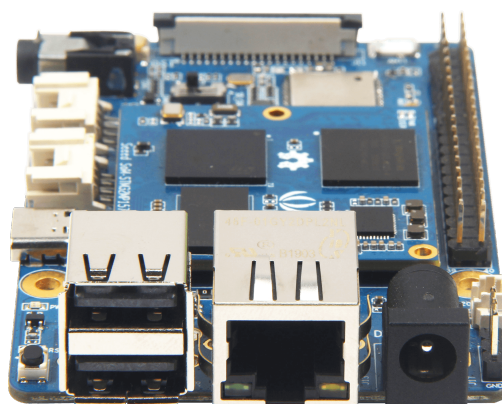

Specifications

● SoM – STM32MP157C

- MPU: STM32MP157C
 - 32-bit Dual-Core Arm® Cortex®-A7
 - 32-bit Arm Cortex®-M4 with FPU/MPU
- PMU: ST PMIC STPMIC1A
- RAM: 512MB DDR3 RAM
- Flash: 4GB eMMC
- Peripherals: 3 x Board-to-Board 70-Pin Connectors
- Dimensions: 38mm x 38mm

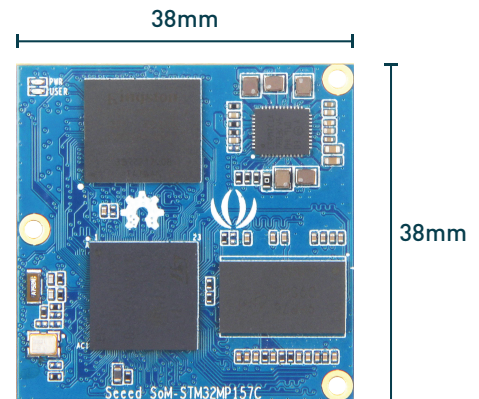

● Carrier Board

- Peripherals
 - 2 x USB Host
 - 1 x Gigabit Ethernet
 - 1 x 3.5mm Audio
 - 1 x MIPI DSI for Screen
 - 1 x DVP for Camera
 - 2 x Grove (GPIO & I2C)
 - 1 x SD Card Slot (on the back)
- WiFi/BLE
 - WiFi 802.11 b/g/n 2.4GHz
 - Bluetooth 4.1 with BLE
- On-Board LED: 1 x Reset, 3 x User, 1 x Power
- Power
 - 1 x DC Jack 12V~24V/2A (12V/2A power input is recommended)
 - 1 x USB Type-C
- Button
 - 1 x Reset
 - 1 x User
 - 1 x Switch
- Dimensions: 56mm x 85mm
- Operating Temperature: 0 ~ 75°C

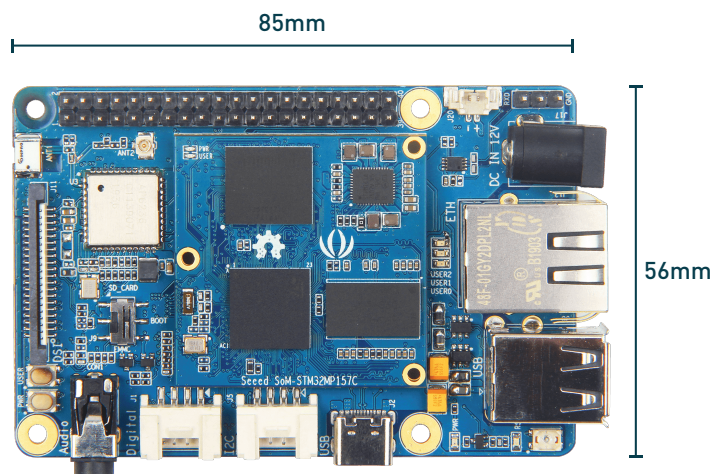

Hardware Overview

Carrier Board Pinout Diagram

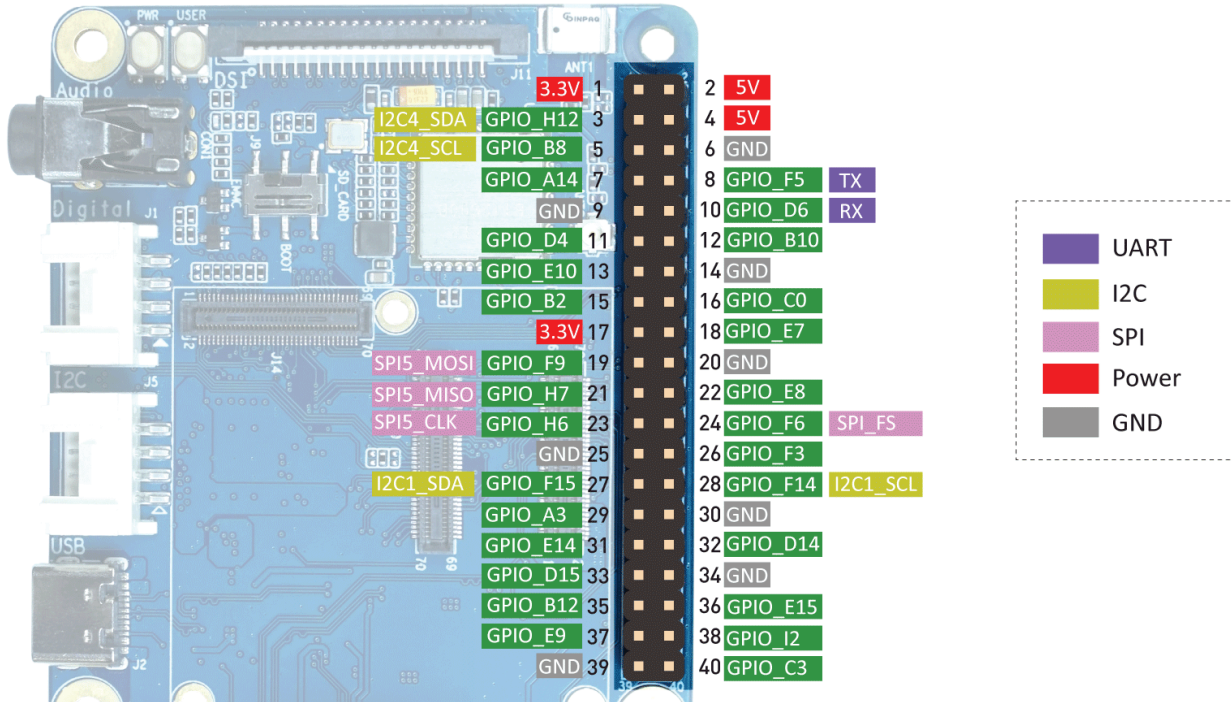

ODYSSEY - STM32MP157C's 40-pins are fully compatible with Raspberry Pi's 40-pins including GPIO, I2C, UART, SPI, I2S and PWM pins.

SoM Components Details

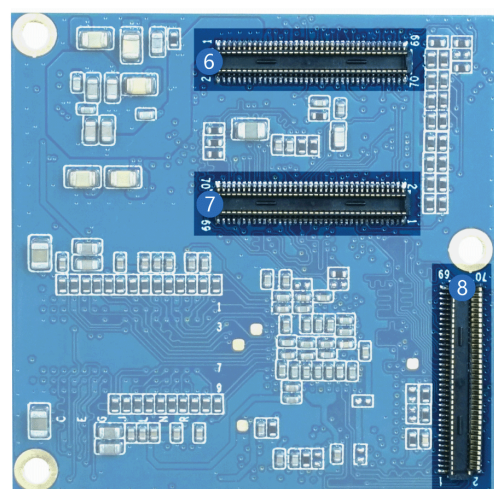
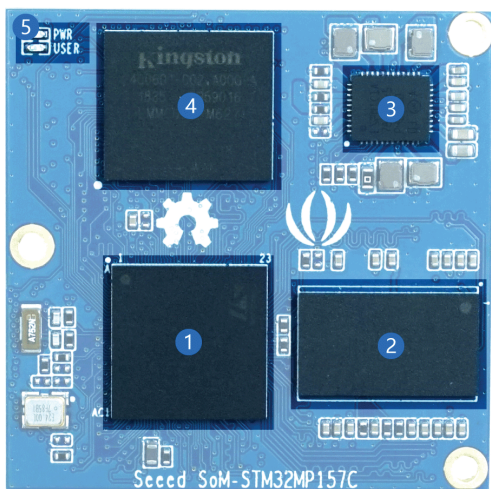

1.STM32MP157C: Development Board Main Control Chip

(Dual architecture processor: Arm® Cortex®-A7 and Cortex®-M4)

2.MT41K256M16TW-107:P: 512MB 16-bit RAM Memory Chip

3.STPMIC1APQR: Power Management Chip

4.EMMC04G-M627: 4GB eMMC Memory

5.LED: When the power supply is successful, the PWR LED will turn on. When the system is running normally, the USER LED will keep flashing.

6, 7, 8: 70-PIN connectors

● Carrier Board Components Details

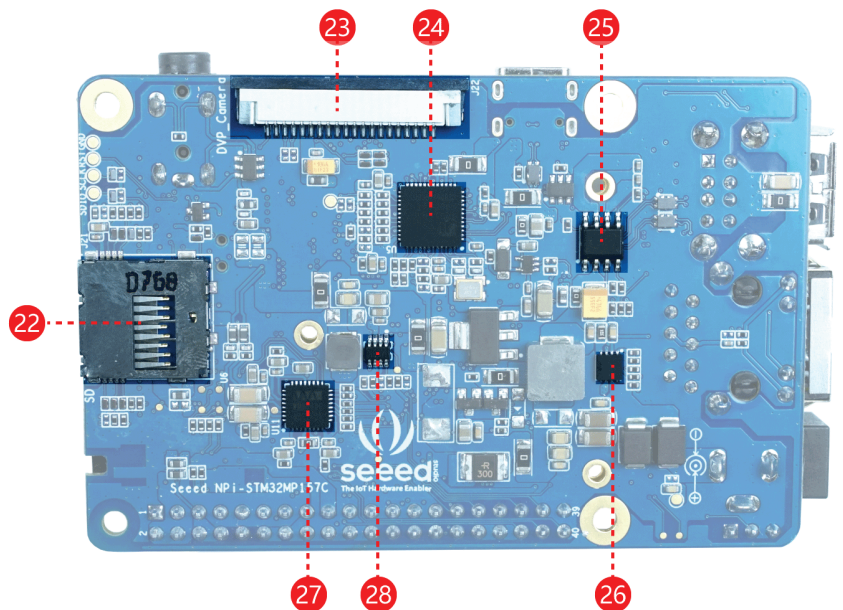
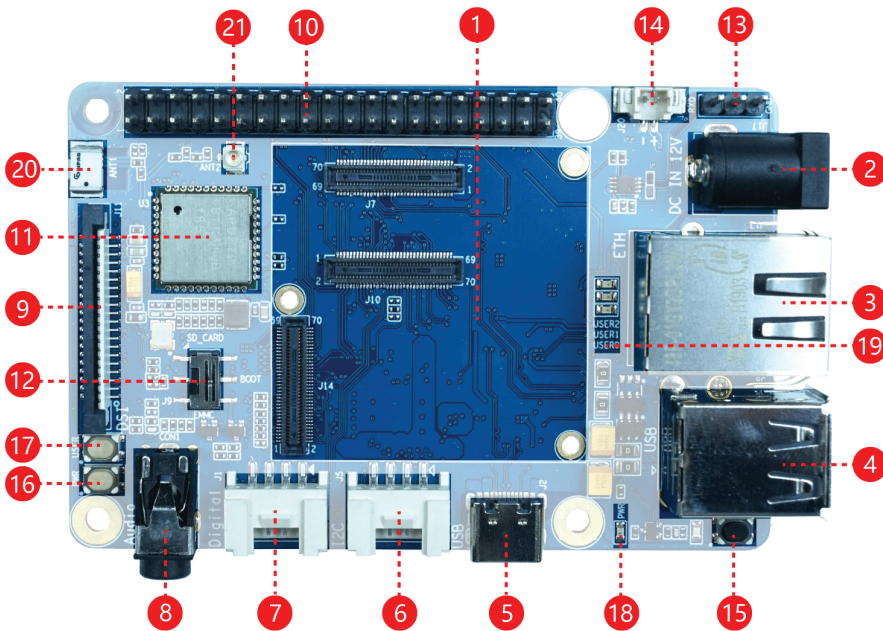

1. **Seed SoM-STM32MP157C Installation Area:** If the user wants to remove the core board, slowly tilt the core board up and then remove. Never remove by hand.
2. **DC Power Input Port:** 12V~24V/2A (12V/2A power input is recommended).
3. **ETH Interface:** Network cable interface can be connected to Gigabit Level Network.
4. **USB Host:** Two USB Host ports.
5. **USB Device:** USB 2.0 Type C. If Type C is used as board power input, a 5V/3A power adapter should be used.
6. **Digital Grove Interface:** Connect Grove modules with digital interface.
7. **I2C Grove Interface:** Connect Grove modules with I2C interface.
8. **American Standard 3.5mm:** Audio interface.
9. **MIPI DSI Interface:** Connect to a display with a MIPI DSI interface (FPC 20Pin 1.0mm).
10. **40 Pin GPIO Interface:** Compatible with Raspberry Pi's 40-Pin.
11. **AP6236:** 2.4G Wi-Fi & BT 4.2 control chip.
12. **Slide Switch:** Can be used to select SD card or eMMC to start.
13. **Debug UART:** The system default debugging serial port. Can enter this serial port to access the system,
14. **JST 1.0mm:** 3V RTC battery interface.
15. **RST Key:** System reset key.
16. **PWR Button:** Long press about 8s to shut down, short press to boot.
17. **User Button:** User programmable buttons.
18. **PWR LED:** Development board power LED.
19. **User LED:** User programmable LED.
20. **ACA-5036-A2-CC-S:** On-board 2.4GHz ceramic antenna.
21. **The IPEX 1 Generation:** 2.4G external antenna seat (When using an external antenna, user needs to remove R49, R51 0Ω welding)
22. **SD Card Slot:** The area in which a Micro-SD card with the system is inserted.
23. **DVP Camera Interface:** Connect to camera with DVP interface (FPC 20Pin 1.0mm).
24. **KSZ9031:** 1000M Network cable drive network card.
25. **STMP2252MTR:** Power switch chip.
26. **MP9943:** Buck DCDC Power chip.
27. **WM8960:** Audio codec chip.
28. **MP2161:** Buck DCDC Power chip.

If you want to learn about setting up the software and other details,
please visit the product wiki at

<http://wiki.seeedstudio.com/ODYSSEY-STM32MP157C/>

If you still have any further questions, please visit

forum.seeedstudio.com

© 2008-2020 Seeed Technology Co.,Ltd. All rights reserved.

X-ON Electronics

Largest Supplier of Electrical and Electronic Components

Click to view similar products for [System-On-Modules - SOM category](#):

Click to view products by [Seeed Studio manufacturer](#):

Other Similar products are found below :

[COMX-CORE-310](#) [COMX-P4040-4G-ENP2](#) [PICOIMX6U10R1GBNI4G](#) [PICOIMX6U10R1GBNI4GBW](#) [MC27561-TIGER](#) [MC27561-LION](#) [CC-WMX6UL-SMPL](#) [CB-52-PUS-110-SX](#) [BD63725BEFV-EVK-002](#) [5728-PJ-4AA-RI](#) [A00150](#) [COMX_P4080](#) [A20-SOM-EVB](#) [RK3188-SOM](#) [RK3188-SOM-4GB](#) [100-1225-1](#) [PICOIMX6Q10R1GBNI4G](#) [Nit6Q](#) [A20-SOM-N8GB](#) [PER-TAICX-A10-001](#) [PER-TAIX2-A10-2280](#) [EDL-mPCIe-MA2485](#) [SOM-5897C7-U0A1E](#) [SOM-6896C7-U2A1E](#) [SCM180-Dual-2G_Industrial](#) [3354-HX-X38-RC](#) [5728-PJ-4AA-RC](#) [6455-JE-3X5-RC](#) [Morph-IC-II](#) [ET876-X7LV](#) [IFC6301-10-P2](#) [IFC6502-00-P1](#) [IFC67A1-00-P1](#) [IFC6701-00-P1](#) [iW-G33M-SCMQ-4L002G-E008G-BII](#) [PWSE1000200B](#) [CS-DEPTHAI-04](#) [MTQ-LNA7-B02](#) [MYC-C8MMQ6-8E2D-180-C](#) [MYD-C4378-4E512D-100-I](#) [MOD5213-100IR](#) [A20-SOM](#) [A20-SOM204-1G](#) [A20-SOM204-1GS16ME16G-MC](#) [AM3352-SOM-EVB](#) [BS1-IC](#) [BS2-IC](#) [102110278](#) [SLS16Y2_792C_256R_256N_0SF_I](#) [SLS12RT52_528C_0R_4QSPI_0SF_I](#)