

INSTRUCTIONS 1/4

Assemble the Pibox Case & GPIO Cable

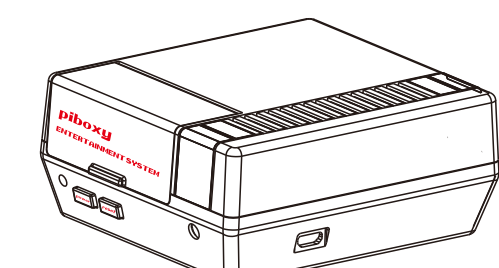

Safety power and Reset button
IR remote controller
Remote control distance:0.1-10m

- 1.1 Screw your Raspberry pi at the 4-screw points inside the Pibox Case.
- 1.2 Connect the 2*6 Cable to Raspberry Pi, PIN 1 and PIN 8 are spare, please note the directions of PIN 2 and PIN 4 (Connected by red lines)

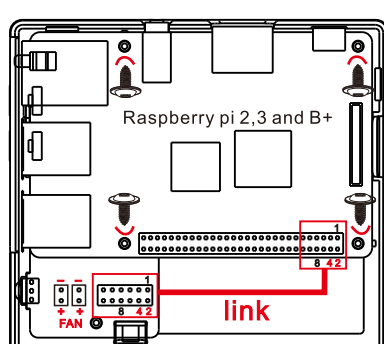

⊘ Do not Connect the Cable to the wrong direction, It will damage your Raspberry Pi.

www.pibox.com

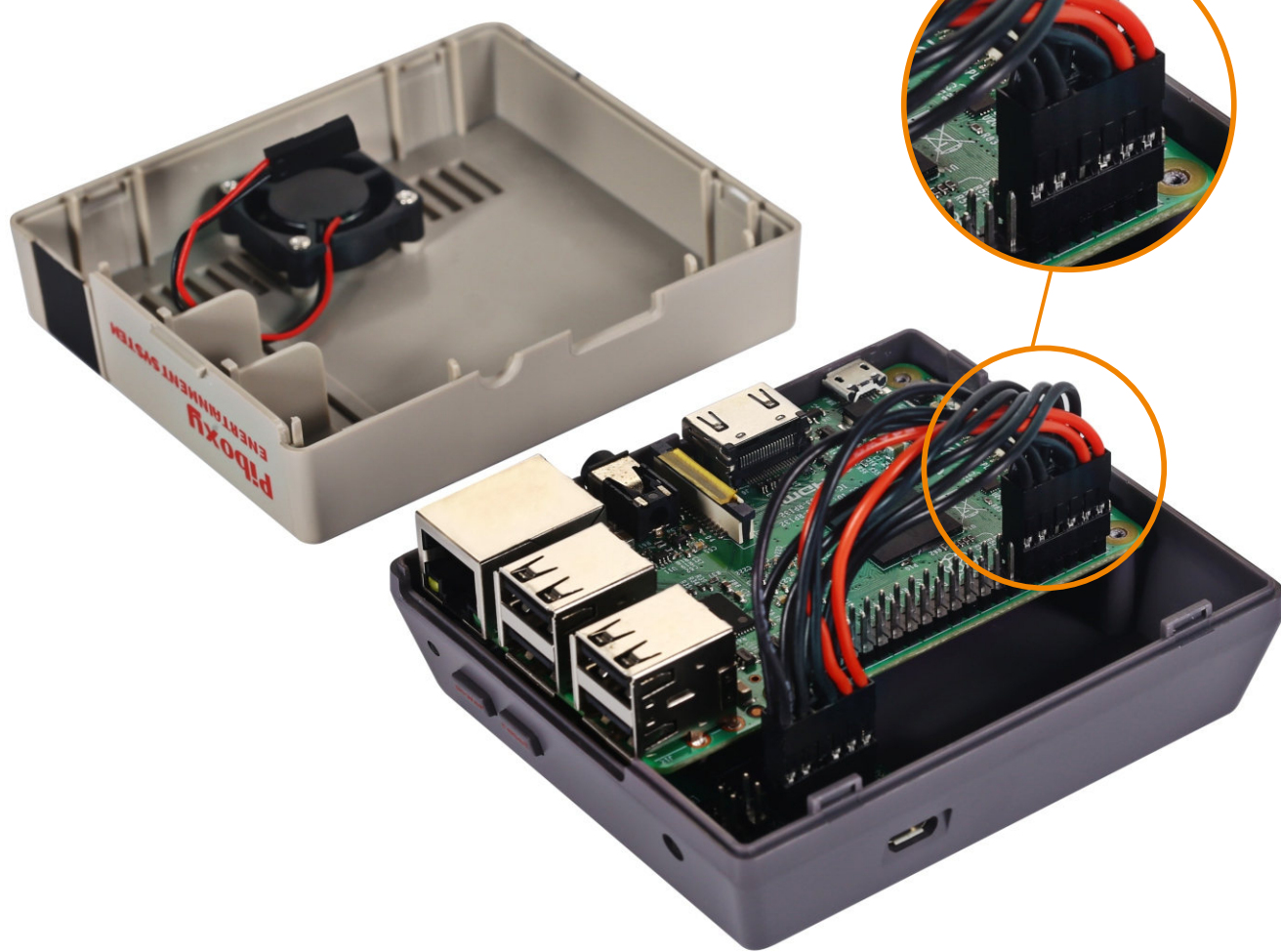

INSTRUCTIONS 2/4

Assemble the FAN and top cover

- 2.1 Two fan sockets are provided, you can connect the mini FAN to any socket.

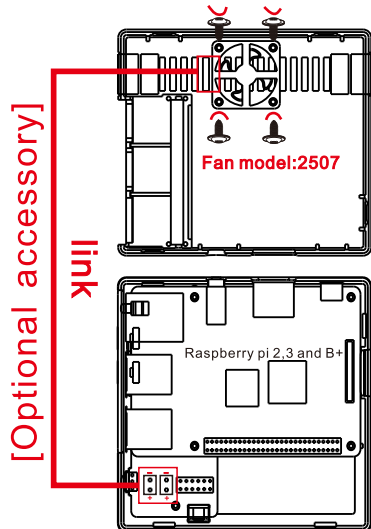

- 2.2 Then you can buckle the top cover of the case to the bottom one.

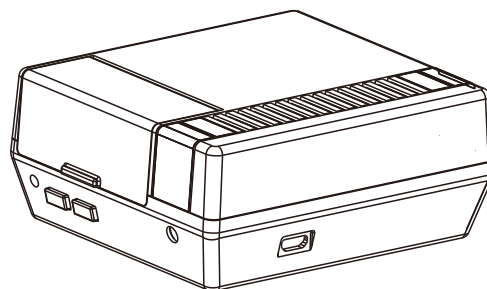

Done

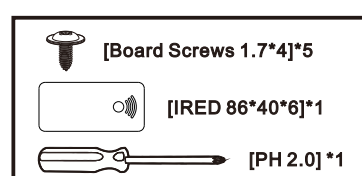

www.pibox.com

INSTRUCTIONS 3/4

Intall Retropie or Raspbian

- 3.1 Dowload the Retropie Image from; <https://retropie.org.uk/download/> or Raspbian from: <https://www.raspberrypi.org/downloads/raspbian/> to your computer.

- 3.2 After downloading the .gz file,extract the file for using the favorite extraction tool.Please rememberthe directory where you extracted the .img file.

- 3.3 Insert Micro SD Card to your Laptop. Download **Etcher** from <https://etcher.io/> and install to your computer.Click Select Image then navigater to the extracted .img file.Then click Select Drive and choose the SD card.Click **Flash!**

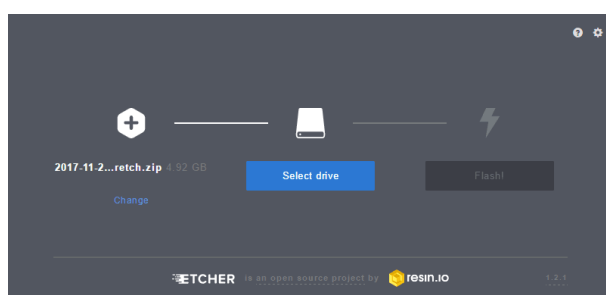

www.pibox.com

INSTRUCTIONS 4/4

Configure Pibox Power/Reset/IR fuction

- 4.1 Insert SD card.Connect your Pibox to a monitor and Keyboard.

- 4.2 Connect your Raspberry Pi to the internet.You may access the internet via LAN or via WIFI.To configure your WIFI follow this link: <https://www.raspberrypi.org/documentation/configuration/wireless/README.md>

- 4.3 Access the Terminal of your Raspbian OS,if you are using Retropie,hit **F4** upon boot up to access the Terminal.In the Terminal,type the one-line command below:

```
curl -sSL pibox.com/install | bash
```

This will run a command that will automatically configure your Raspbererry Pi to access Pibox function,you do not need reboot your Raspbererry pi.

If the Pibox driver is not installed, the RESET button will not work,but the Power Button and Infrared control can also turn on/off the Raspbererry Pi (about 40-60 seconds to complete the action).it will cut off the power directly, may damage the circuit board.

Note: When the Board is powered on/off or rebooted, the LED will blink until the action is completed.

Please follow the link for more information: <https://github.com/PiboxTeam/remoteswitch>

www.pibox.com

X-ON Electronics

Largest Supplier of Electrical and Electronic Components

Click to view similar products for [Seed Studio Accessories](#) category:

Click to view products by [Seed Studio](#) manufacturer:

Other Similar products are found below :

[101990565](#) [101990564](#) [101020003](#) [101020004](#) [101020025](#) [101020028](#) [101020038](#) [101020058](#) [101020472](#) [101020580](#) [101990029](#)
[101990058](#) [101990061](#) [101990065](#) [102020143](#) [102070002](#) [102070004](#) [102070007](#) [102070008](#) [102070011](#) [102991175](#) [102991176](#)
[103010002](#) [103020005](#) [103020007](#) [103020008](#) [103020010](#) [103020012](#) [103020030](#) [103020133](#) [103020135](#) [103020136](#) [103020137](#)
[103020252](#) [103020272](#) [103030005](#) [103030009](#) [103030075](#) [103030275](#) [103030276](#) [103030335](#) [103100063](#) [103990183](#) [103990445](#)
[104020006](#) [104020048](#) [104020108](#) [104020109](#) [104030001](#) [104030009](#)