

J-Link Adapters

The following adapters are available for J-Link:

- [J-Link JTAG Isolator](#)
- [J-Link SWD Isolator](#)
- [J-Link Supply Adapter](#)
- [J-Link Needle Adapter](#)
- [J-Link 6-pin Adapter](#)
- [J-Link RX Adapter](#)
- [J-Link RX FINE Adapter](#)
- [J-Link 19-pin Cortex-M Adapter](#)
- [J-Link 9-pin Cortex-M Adapter](#)
- [J-Link 2mm Adapter](#)
- [J-Link Altera Adapter](#)
- [J-Link ARM-14 Adapter](#)
- [J-Link Measurement+Patch Adapter](#)
- [J-Link Microchip Adapter](#)
- [J-Link Mictor 38 Adapter](#)
- [J-Link PPC 14-pin Adapter](#)
- [J-Link Signal Smoothing Adapter](#)
- [J-Link 14-pin TI Adapter](#)
- [J-Link TI-CTI-20 Adapter](#)

J-Link JTAG Isolator

The J-Link JTAG Isolator can be connected between J-Link and any ARM-board that uses the standard 20-pin JTAG-ARM connector to provide electrical isolation. This is essential when the development tools are not connected to the same ground as the application. It is also useful to protect the development tools from electrical spikes that often occur in some applications, such as motor control applications. Another typical field of application is development of products with sensors or other analog circuitry, in which case the target hardware is protected from electrical noise originating from the development PC.

The J-Link JTAG Isolator is compatible with [J-Link BASE](#), [J-Link PRO](#), [J-Link ULTRA+](#), [J-Link PLUS](#) and [Flasher ARM](#).



J-Link SWD Isolator

The J-Link SWD Isolator can be connected between [J-Link](#) and any ARM-board that uses the standard 20-pin 0.1" male connector to provide electrical isolation. This is essential when the development tools are not connected to the same ground as the application. It is also useful to protect the development tools from electrical spikes that often occur in some applications, such as motor control applications. Another typical field of application is development of products with sensors or other analog circuitry, in which case the target hardware is protected from electrical noise originating from the development PC.

The J-Link SWD Isolator is compatible with [J-Link BASE](#), [J-Link PRO](#), [J-Link ULTRA+](#), [J-Link PLUS](#) and [Flasher ARM](#).



J-Link Supply Adapter

The J-Link Supply Adapter provides a fixed I/O voltage level for $V_{T_{Ref}}$. It eliminates the need to connect $V_{T_{Ref}}$ (pin1) to the target.

In general, the target provides its I/O voltage level ($V_{T_{Ref}}$) on pin 1 to the debug probe insuring the debug probe uses the right I/O voltages and avoiding damage of the target debug pins. If signal $V_{T_{Ref}}$ is not desired on the target board it can be omitted by using the J-Link Supply Adapter, manually setting the I/O voltage. Default I/O voltage is 3.3 V. For increased flexibility the J-Link Supply Adapter can adapt to other target voltages in the range from 1.2 V to 5.0 V by replacing a single resistor on the adapter.

The Supply Adapter can be inserted between J-Link and the target maintaining a 1:1 connection of all debug signals (except $V_{T_{Ref}}$ /pin 1). It has a standard 20-pin 0.1" socket towards the J-Link debug probe and a standard 20-pin 0.1" header on the target side. The main reason for using the adapter is to reduce the number of connections to the target, especially in production environments. It can also be used with Flasher ARM. For dual wire debug interfaces such as SWD, typically only 3 wires are still required: SWDIO and SWDCLK as well as GND. For single wire interfaces such as SPD, the number of connections is reduced to 2 accordingly.

The J-Link Supply Adapter is compatible with [J-Link BASE](#), [J-Link PRO](#), [J-Link ULTRA+](#), [J-Link PLUS](#) and [Flasher ARM](#).

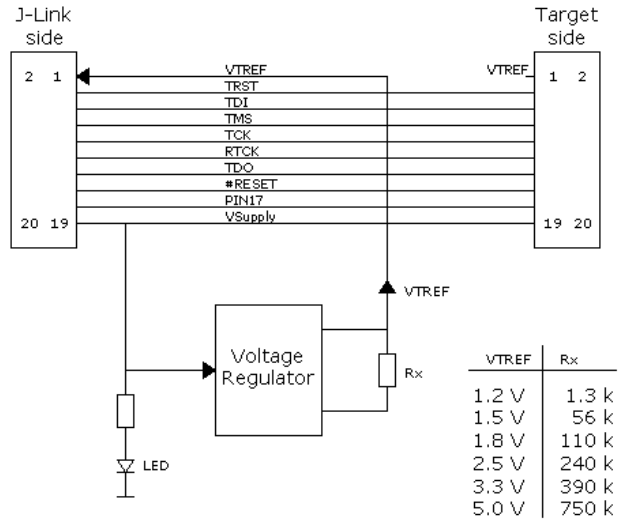
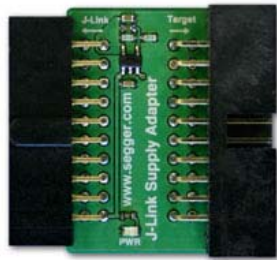

Block diagram of the J-Link Supply Adapter

J-Link Needle Adapter

The J-Link Needle Adapter has been designed to connect J-Link to a PCB which does not come with a mating connector or programming header. The designed pattern with 3 locating pins ensures, that the adapter can not be connected the wrong way.

The needle adapter allows manufacturers to save costs and space on their PCBs since there is no need to provide the PCB with additional connectors.

It adapts from the 20-pin 0.1" JTAG to a 10-pin needle connector.

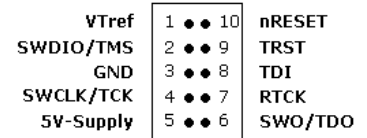

J-Link 6-pin Adapter

The J-Link 6-pin Adapter has been designed to connect J-Link to a PCB which does not come with a mating connector or programming header. The designed pattern with 3 locating pins ensures, that the adapter can only be connected in one way.

The 6-pin Adapter allows manufacturers to save costs and space on their PCBs since there is no need to provide the PCB with additional connectors.

It adapts from the 20-pin 0.1" JTAG to a 6-pin needle connector.

J-Link 6-pin Adapter is compatible with [J-Link BASE](#), [J-Link PRO](#), [J-Link ULTRA+](#), [J-Link EDU](#), [Flasher ARM](#), [Flasher RX](#), [Flasher PPC](#) and [Flasher Portable](#).

Please note, that the 6-pin Adapter supports SWD only. If JTAG support is required, use the [J-Link Needle Adapter](#) instead.

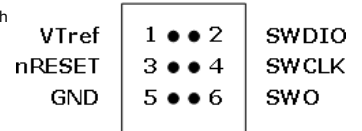

J-Link RX Adapter

The J-Link RX Adapter allows connections between J-Link and target hardware which comes with the Renesas RX600/200/100 series MCUs. The J-Link RX adapter is able to optionally power the connected target hardware. 3.3V or 5V supply voltage can be selected using a Jumper. The target is supplied via the Vtref connection when the supply option is jumpered.



J-Link RX FINE Adapter

The J-Link RX FINE Adapter allows connections between J-Link and Renesas RX based target hardware that supports the Renesas FINE interface (RX63xx, RX2xx, RX1xx CPUs).



J-Link 19-pin Cortex-M Adapter

The J-Link 19-pin Cortex-M Adapter allows JTAG, SWD and SWO connections between J-Link and Cortex-M based target hardware systems. It adapts from the 20-pin 0.1" JTAG connector to a 19-pin 0.05" Samtec FTSH connector as defined by ARM.

The J-Link 19-pin Cortex-M Adapter may also be used to connect J-Link to a non Cortex-M target as far as the target connector uses the same pinout as shown below.

By default, TRST is not connected, but the Cortex-M Adapter comes with a solder bridge (NR1) which allows TRST to be connected to pin 9 of the Cortex-M adapter.

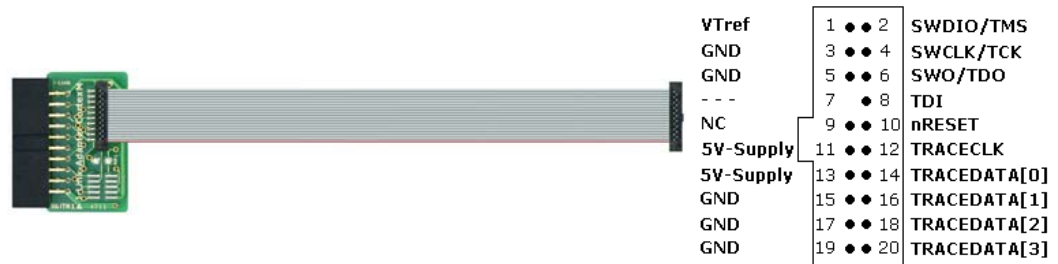

J-Link 9-pin Cortex-M Adapter

The J-Link 9-pin Cortex-M Adapter allows JTAG, SWD and SWO connections between J-Link and Cortex-M based target hardware systems. It adapts from the 20-pin 0.1" JTAG connector to a 9-pin 0.05" Samtec FTSH connector as defined by ARM.

The J-Link 9-pin Cortex-M Adapter may also be used to connect J-Link to a non Cortex-M target as far as the target connector uses the same pinout as shown below.

By default, TRST is not connected, but the Cortex-M Adapter comes with a solder bridge (NR1) which allows TRST to be connected to pin 9 of the Cortex-M adapter.



J-Link 2mm Adapter

The J-Link 2mm Adapter adapts from the standard 20-pin J-Link connector to a 20-pin 2mm-pitch connector. The J-Link 2mm Adapter is a 1:1 adapter, since the pinout of the 2mm pitch connector is identical to the standard 20-pin J-Link connector.



VTref	1 ● 2	---
nTRST	3 ● 4	GND
TDI	5 ● 6	GND
TMS	7 ● 8	GND
TCK	9 ● 10	GND
RTCK	11 ● 12	GND
TDO	13 ● 14	GND
RESET	15 ● 16	GND
DBGREQ	17 ● 18	GND
5V-Supply	19 ● 20	GND

Pins 14, 16, 18, 20:
On some models like the high-end model J-Link PRO, these pins may not be connected to GND but are reserved for future use/extension. In case of doubt, leave open on target hardware.

J-Link Altera Adapter

The J-Link Altera Adapter connects to the 10 pin Altera JTAG connector providing debug access to FPGA based MCU cores like the dual-core ARM Cortex-A9 in the Cyclone V devices.

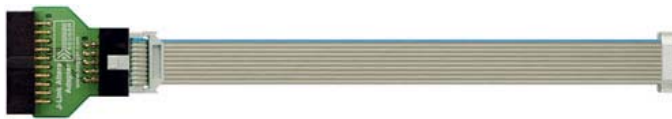

TCK	1 ● 2	GND
TDO	3 ● 4	VCCIO
TMS	5 ● 6	TRST
---	7 ● 8	---
TDI	9 ● 10	GND

J-Link ARM-14 Adapter

This adapter allows to use J-Link with ARM7/9/11 targets using this 14-pin 0.1" mating JTAG connector defined by ARM. The 14-pin connector, though defined by ARM as an alternative to the 20-pin connector is not widely used on modern eval boards.



VTref	1 ● 2	GND
nTRST	3 ● 4	GND
TDI	5 ● 6	GND
TMS	7 ● 8	GND
TCK	9 ● 10	GND
TDO	11 ● 12	RESET
VTref	13 ● 14	GND

J-Link Measurement+Patch Adapter

The J-Link Measurement+Patch Adapter provides test points for all debug signals to allow easy access for test probes. It has a standard 20-pin 0.1" socket towards the J-Link debug probe and a standard 20-pin 0.1" header on the target side and can directly be inserted between the J-Link and the debug cable maintaining a 1:1 connection of all debug signals. For increased flexibility VTref on pin 1 and the target supply voltage on pin 19 can be interrupted by means of two jumpers.

The J-Link Measurement+Patch Adapter allows easy customized wiring between J-Link and targets that do not provide a standard debug connector that fits to any of the adapters available for J-Link (e.g. the Discovery Boards from ST Microelectronics). The wiring between J-Link and the target is done via colored jumper wires that are shipped with the J-Link Measurement+Patch Adapter.



J-Link Microchip Adapter

The J-Link Microchip Adapter allows debug connections between J-Link and target hardware which comes with Microchip PIC32 series MCUs. It supports the RJ12 modular debug connector as specified by Microchip as well as the 14-pin dual row MIPS debug header and the Microchip 6-pin single row PICKit connector (options, can be soldered by customer on demand).

Pin	Signal
1	#MCLR
2	VDD
3	GND
4	DIO/PGD/RB7

Note that the delivered modular cable will invert the pin order as shown in the pinout below.

5	CLK/PGC/RB6
6	NC

 [Schematic](#)

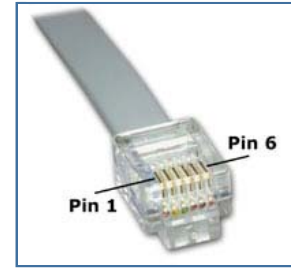

J-Link Mictor 38 Adapter

The J-Link Mictor 38 Adapter connects to the 38 pin Mictor connector. The pin out follows the single target connector pinout specification as defined in the ARM "ETM Architecture Specification".

The adapter connects the GND and JTAG pins to their counterparts on the 20-pin J-Link. Trace pins present on the Mictor connector are not connected as they are not present on the 20-pin J-Link connector. The 38-pin Mictor side of the adapter can be plugged either directly into the target side or via trace cable. The J-Link side connects to J-Link via 20-pin flat cable.

If you need trace capability, take a look at the [J-Trace Cortex-M](#) and [J-Trace ARM](#) Debug + Trace Probes.

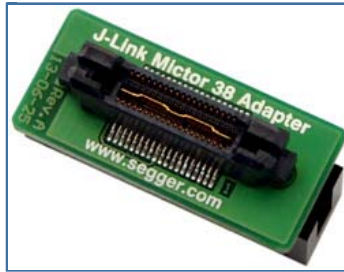

Pin	Signal
5	GND
9	nRES
11	TDO
12,14	VTref
13	RTCK
15	TCK
17	TMS
19	TDI
21	TRST

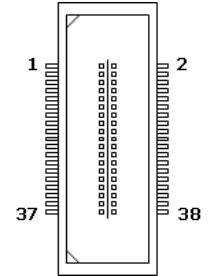

J-Link PPC 14-pin Adapter

The J-Link PPC 14 pin Adapter allows JTAG connections between J-Link and target hardware which use an MCU with Power Architecture or PowerPC. It adapts from the 20-pin 0.1" to a 14-pin 0.1" JTAG connector.

Note: J-Link support for PowerPC is not yet available.

 [Subscribe to J-Link software notification in order to be informed as soon as PowerPC support is available](#)



TDI	1 ●● 2	GND
TDO	3 ●● 4	GND
TCK	5 ●● 6	GND
---	7 8	---
nRES	9 ●● 10	TMS
VDDE7	11 ●● 12	GND
nRDY	13 ●● 14	JCOMP

J-Link Signal Smoothing Adapter

The J-Link Signal Smoothing Adapter can be inserted between the J-Link debug probe and the debug target to overcome signal integrity issues. Depending on target load capacitance JTAG signals might be affected by overshoot and ringing. In this case user adjustable series resistors (default 47R) allow for damping critical signal rise/fall times leading to improved signal integrity.

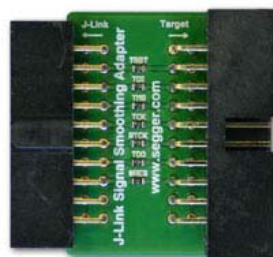

J-Link 14-pin TI Adapter

The J-Link TI 14-pin Adapter allows JTAG connections between J-Link and target hardware which use a TI MCU and provides a 14-pin connector (e.g. the BeagleBoard with an OMAP3530 on it), defined by TI. It adapts from the 20-pin 0.1" to a 14-pin 0.1" JTAG connector.



TMS	1 ●● 2	TRST
TDI	3 ●● 4	GND
VCCS	5 ●● 6	NC
TDO	7 ●● 8	GND
RTCK	9 ●● 10	GND
TCK	11 ●● 12	GND
EMU0	13 ●● 14	EMU1

J-Link TI-CTI-20 Adapter

J-Link TI-CTI-20 Adapter adapts from the standard J-Link 20-pin 0.1" target connector to TI CTI-20 connector.

This adapter allows to connect [J-Link](#) to eval boards with TI MCUs that are equipped with a TI CTI-20 connector, e.g. the [AM335x evaluation module](#).

As can be seen in the image below, the key on pin 6 ensures, that the adapter can not be connected the wrong way.

The adapter is compatible to all available [J-Link and J-Trace models](#).

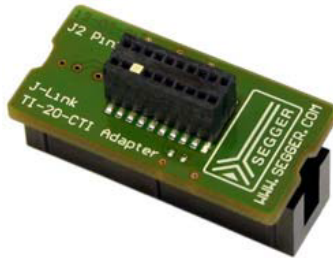

TMS	1 ●● 2	TRST
TDI	3 ●● 4	GND
VTref	5 ● 6	NC
TDO	7 ●● 8	GND
RTCK	9 ●● 10	GND
TCK	11 ●● 12	GND
EMU0	13 ●● 14	EMU1
NSRST	15 ●● 16	GND
NC	17 ●● 18	NC
NC	19 ●● 20	GND

[Imprint](#) [Disclaimer](#) [Sitemap](#)

© 2014, www.segger.com, All rights reserved.

X-ON Electronics

Largest Supplier of Electrical and Electronic Components

Click to view similar products for [segger microcontroller manufacturer](#):

Other Similar products are found below :

[SD Card Adapter](#) [J-Link RX Adapter](#) [8.06.03](#) [5.16.01](#) [FLASHER PORTABLE](#) [5.50.01.US](#) [US POWER ADAPTER FOR FLASHER 5/ST7](#)
[5.17.01](#) [8.20.00](#) [6.68.18](#) [8.06.17](#) [J-Link ARM-14 Adapter](#) [8.06.13](#) [6.32.32](#) [6.30.00](#) [6.68.20](#) [8.06.21](#) [8.07.10](#) [8.14.28](#) [8.06.14](#) [J-LINK](#)
[SUPPLY ADAPTER](#) [6.68.19](#) [8.06.24](#) [8.06.13](#) [J-LINK MEASUREMENT+PATCH ADAPTER](#) [5.09.01](#) [FLASHER STM8](#) [8.06.23](#) [6.37.04](#)
[6.37.01](#) [JTAG Isolator](#) [J-Link TI-CTI-20 Adapter](#) [8.06.18](#) [5.17.01](#) [FLASHER PRO](#) [8.06.09](#) [J-LINK MICROCHIP ADAPTER](#) [8.07.00](#) [JTAG](#)
[ISOLATOR](#) [8.06.05](#) [10-PIN NEEDLE ADAPTER](#) [6.90.00](#) [8.06.22](#) [8.06.25](#) [Flasher STM8](#) [8.06.26](#) [8.18.00](#) [8.06.05](#) [8.06.03](#) [J-LINK 14PIN](#)
[TIADAPTER](#) [8.06.06](#) [J-LINK TI CTI20ADAPTER](#) [5.16.02](#) [8.06.19](#) [5.07.01](#) [FLASHER ARM](#) [J-Link PRO](#) [8.06.28](#) [Flasher ARM](#) [J-Link](#)
[ULTRA+](#) [8.16.28](#) [J-LINK ULTRA+](#) [8.19.28](#)