

J-Link / J-Trace *User Guide*



Software Version V4.86
Manual Rev. 2

Date: June 6, 2014

Document: UM08001



A product of SEGGER Microcontroller GmbH & Co. KG

www.segger.com

Disclaimer

Specifications written in this document are believed to be accurate, but are not guaranteed to be entirely free of error. The information in this manual is subject to change for functional or performance improvements without notice. Please make sure your manual is the latest edition. While the information herein is assumed to be accurate, SEGGER Microcontroller GmbH & Co. KG (the manufacturer) assumes no responsibility for any errors or omissions. The manufacturer makes and you receive no warranties or conditions, express, implied, statutory or in any communication with you. The manufacturer specifically disclaims any implied warranty of merchantability or fitness for a particular purpose.

Copyright notice

You may not extract portions of this manual or modify the PDF file in any way without the prior written permission of the manufacturer. The software described in this document is furnished under a license and may only be used or copied in accordance with the terms of such a license.

© 2014 SEGGER Microcontroller GmbH & Co. KG, Hilden / Germany

Trademarks

Names mentioned in this manual may be trademarks of their respective companies.

Brand and product names are trademarks or registered trademarks of their respective holders.

Contact address

SEGGER Microcontroller GmbH & Co. KG

In den Weiden 11
D-40721 Hilden

Germany

Tel. +49 2103-2878-0

Fax. +49 2103-2878-28

Email: support@segger.com

Internet: <http://www.segger.com>

Revisions

This manual describes the J-Link and J-Trace device.

For further information on topics or routines not yet specified, please contact us.

Revision	Date	By	Explanation
V4.86 Rev 2	140606	AG	Chapter "Device specifics" * Section "Silicon Labs - EFM32 series devices" added
V4.86 Rev. 1	140527	JL	Chapter "Related Software" * Section "GDB Server" Command line options -halt / -nohalt added. Description for GDB Server CL version added.
V4.86 Rev. 0	140519	AG	Chapter "Flash download" Section "Mentor Sourcery CodeBench" added.
V4.84 Rev. 0	140321	EL	Chapter "Working with J-Link" * Section "Virtual COM Port (VCOM) improved." Chapter "Target interfaces and adapters" * Section "Pinout for SWD + Virtual COM Port (VCOM) added."

Revision	Date	By	Explanation
V4.82 Rev. 1	140228	EL	Chapter "Related Software" * Section "Command line options" Extended command line option -speed. Chapter "J-Link software and documentation package" * Section "J-Link STR91x Commander" Added command line option parameter to specify a customized scan-chain. Chapter "Working with J-Link" * Section "Virtual COM Port (VCOM) added." Chapter "Setup" * Section "Getting started with J-Link and DS-5"
V4.82 Rev. 0	140218	JL	Chapter "Related Software" * Section "GDB Server" Command line option -notimout added.
V4.80f Rev. 0	140204	JL	Chapter "Related Software" * Section "GDB Server" Command line options and remote commands added.
V4.80 Rev. 1	131219	JL/ NG	Chapter "Related Software" * Section "GDB Server" Remote commands and command line options description improved. Several corrections.
V4.80 Rev. 0	131105	JL	Chapter "Related Software" * Section "GDB Server" SEGGER-specific GDB protocol extensions added.
V4.76 Rev. 3	130823	JL	Chapter "Flash Download" * Replaced references to GDB Server manual. Chapter "Working withc J-Link" * Replaced references to GDB Server manual.
V4.76 Rev. 2	130821	JL	Chapter "Related Software" * Section "GDB Server" Remote commands added.
V4.76 Rev. 1	130819	JL	Chapter "Related Software" * Section "SWO Viewer" Sample code updated.
V4.76 Rev. 0	130809	JL	Chapter "Related Software" * Sections reordered and updated. Chapter "Setup" * Section "Using JLinkARM.dll moved here.
V4.71b Rev. 0	130507	JL	Chapter "Related Software" * Section "SWO Viewer" Added new command line options.
V4.66 Rev. 0	130221	JL	Chapter "Introduction" * Section "Supported OS" Added Linux and Mac OSX
V4.62b Rev. 0	130219	EL	Chapter "Introduction" * Section "J-Link / J-Trace models" Clock rise and fall times updated.
V4.62 Rev. 0	130129	JL	Chapter "Introduction" * Section "J-Link / J-Trace models" Sub-section "J-link ULTRA" updated.
V4.62 Rev. 0	130124	EL	Chapter "Target interfaces and adapters" * Section "9-pin JTAG/SWD connector" Pinout description corrected.

Revision	Date	By	Explanation
V4.58 Rev. 1	121206	AG	Chapter "Intoduction" * Section "J-Link / J-Trace models" updated.
V4.58 Rev. 0	121126	JL	Chapter "Working with J-Link" * Section "J-Link script files" Sub-section "Executing J-Link script files" updated.
V4.56b Rev. 0	121112	JL	Chapter "Related Software" * Section "J-Link SWO Viewer" Added sub-section "Configure SWO output after device reset"
V4.56a Rev. 0	121106	JL	Chapter "Related Software" * Section "J-Link Commander" Renamed "Commander script files" to "Commander files" and "script mode" to "batch mode".
V4.56 Rev. 0	121022	AG	Renamed "J-Link TCP/IP Server" to "J-Link Remote Server".
V4.54 Rev. 1	121009	JL	Chapter "Related Software" * Section "TCP/IP Server", subsection "Tunneling Mode" added.
V4.54 Rev. 0	120913	EL	Chapter "Flash Breakpoints" * Section "Licensing" updated. Chapter "Device specifics" * Section "Freescale", subsection "Data flash support" added.
V4.53c Rev. 0	120904	EL	Chapter "Licensing" * Section "Device-based license" updated.
V4.51h Rev. 0	120717	EL	Chapter "Flash download" * Section "J-Link commander" updated. Chapter "Support and FAQs" * Section "Frequently asked questions" updated. Chapter "J-Link and J-Trace related software" * Section "J-Link Commander" updated.
V4.51e Rev. 1	120704	EL	Chapter "Working with J-Link" * Section "Reset strategies" updated and corrected. Added reset type 8.
V4.51e Rev. 0	120704	AG	Chapter "Device specifics" * Section "ST" updated and corrected.
V4.51b Rev. 0	120611	EL	Chapter "J-Link and J-Trace related software" * Section "SWO Viewer" added.
V4.51a Rev. 0	120606	EL	Chapter "Device specifics" * Section "ST", subsection "ETM init" for some STM32 devices added.. * Section "Texas Instruments" updated. Chapter "Target interfaces and adapters" * Section "Pinout for SWD" updated.
V4.47a Rev. 0	120419	AG	Chapter "Device specifics" * Section "Texas Instruments" updated.
V4.46 Rev. 0	120416	EL	Chapter "Support" updated.
V4.42 Rev. 0	120214	EL	Chapter "Working with J-Link" * Section "J-Link script files" updated.

Revision	Date	By	Explanation
V4.36 Rev. 1	110927	EL	Chapter "Flash download" added. Chapter "Flash breakpoints" added. Chapter "Target interfaces and adapters" * Section "20-pin JTAG/SWD connector" updated. Chapter "RDI" added. Chapter "Setup" updated. Chapter "Device specifics" updated.
V4.36 Rev. 0	110909	AG	Chapter "Working with J-Link" * Section "J-Link script files" updated.
V4.26 Rev. 1	110513	KN	Chapter "Introduction" * Section "J-Link / J-Trace models" corrected.
V4.26 Rev. 0	110427	KN	Several corrections.
V4.24 Rev. 1	110228	AG	Chapter "Introduction" * Section "J-Link / J-Trace models" corrected. Chapter "Device specifics" * Section "ST Microelectronics" updated.
V4.24 Rev. 0	110216	AG	Chapter "Device specifics" * Section "Samsung" added. Chapter "Working with J-Link" * Section "Reset strategies" updated. Chapter "Target interfaces and adapters" * Section "9-pin JTAG/SWD connector" added.
V4.23d	110202	AG	Chapter "J-Link and J-Trace related software" * Section "J-Link software and documentation package in detail" updated. Chapter "Introduction" * Section "Built-in intelligence for supported CPU-cores" added.
V4.21g	101130	AG	Chapter "Working with J-Link" * Section "Reset strategies" updated. Chapter "Device specifics" * Section "Freescale" updated. Chapter "Flash download and flash breakpoints" * Section "Supported devices" updated * Section "Setup for different debuggers (CFI flash)" updated.
V4.21	101025	AG	Chapter "Device specifics" * Section "Freescale" updated.
V4.20j	101019	AG	Chapter "Working with J-Link" * Section "Reset strategies" updated.
V4.20b	100923	AG	Chapter "Working with J-Link" * Section "Reset strategies" updated.
90	100818	AG	Chapter "Working with J-Link" * Section "J-Link script files" updated. * Section "Command strings" updated. Chapter "Target interfaces and adapters" * Section "19-pin JTAG/SWD and Trace connector" corrected. Chapter "Setup" * Section "J-Link configurator added."
89	100630	AG	Several corrections.
88	100622	AG	Chapter "J-Link and J-Trace related software" * Section "SWO Analyzer" added.
87	100617	AG	Several corrections.

Revision	Date	By	Explanation
86	100504	AG	Chapter "Introduction" * Section "J-Link / J-Trace models" updated. Chapter "Target interfaces and adapters" * Section "Adapters" updated.
85	100428	AG	Chapter "Introduction" * Section "J-Link / J-Trace models" updated.
84	100324	KN	Chapter "Working with J-Link and J-Trace" * Several corrections Chapter Flash download & flash breakpoints * Section "Supported devices" updated
83	100223	KN	Chapter "Introduction" * Section "J-Link / J-Trace models" updated.
82	100215	AG	Chapter "Working with J-Link" * Section "J-Link script files" added.
81	100202	KN	Chapter "Device Specifics" * Section "Luminary Micro" updated. Chapter "Flash download and flash breakpoints" * Section "Supported devices" updated.
80	100104	KN	Chapter "Flash download and flash breakpoints" * Section "Supported devices" updated
79	091201	AG	Chapter "Working with J-Link and J-Trace" * Section "Reset strategies" updated. Chapter "Licensing" * Section "J-Link OEM versions" updated.
78	091023	AG	Chapter "Licensing" * Section "J-Link OEM versions" updated.
77	090910	AG	Chapter "Introduction" * Section "J-Link / J-Trace models" updated.
76	090828	KN	Chapter "Introduction" * Section "Specifications" updated * Section "Hardware versions" updated * Section "Common features of the J-Link product family" updated Chapter "Target interfaces and adapters" * Section "5 Volt adapter" updated
75	090729	AG	Chapter "Introduction" * Section "J-Link / J-Trace models" updated. Chapter "Working with J-Link and J-Trace" * Section "SWD interface" updated.
74	090722	KN	Chapter "Introduction" * Section "Supported IDEs" added * Section "Supported CPU cores" updated * Section "Model comparison chart" renamed to "Model comparison" * Section "J-Link bundle comparison chart" removed
73	090701	KN	Chapter "Introduction" * Section "J-Link and J-Trace models" added * Sections "Model comparison chart" & "J-Link bundle comparison chart" added Chapter "J-Link and J-Trace models" removed Chapter "Hardware" renamed to "Target interfaces & adapters" * Section "JTAG Isolator" added Chapter "Target interfaces and adapters" * Section "Target board design" updated Several corrections

Revision	Date	By	Explanation
72	090618	AG	Chapter "Working with J-Link" * Section "J-Link control panel" updated. Chapter "Flash download and flash breakpoints" * Section "Supported devices" updated. Chapter "Device specifics" * Section "NXP" updated.
71	090616	AG	Chapter "Device specifics" * Section "NXP" updated.
70	090605	AG	Chapter "Introduction" * Section "Common features of the J-Link product family" updated.
69	090515	AG	Chapter "Working with J-Link" * Section "Reset strategies" updated. * Section "Indicators" updated. Chapter "Flash download and flash breakpoints" * Section "Supported devices" updated.
68	090428	AG	Chapter "J-Link and J-Trace related software" * Section "J-Link STM32 Commander" added. Chapter "Working with J-Link" * Section "Reset strategies" updated.
67	090402	AG	Chapter "Working with J-Link" * Section "Reset strategies" updated.
66	090327	AG	Chapter "Background information" * Section "Embedded Trace Macrocell (ETM)" updated. Chapter "J-Link and J-Trace related software" * Section "Dedicated flash programming utilities for J-Link" updated.
65	090320	AG	Several changes in the manual structure.
64	090313	AG	Chapter "Working with J-Link" * Section "Indicators" added.
63	090212	AG	Chapter "Hardware" * Several corrections. * Section "Hardware Versions" Version 8.0 added.
62	090211	AG	Chapter "Working with J-Link and J-Trace" * Section "Reset strategies" updated. Chapter J-Link and J-Trace related software * Section "J-Link STR91x Commander (Command line tool)" updated. Chapter "Device specifics" * Section "ST Microelectronics" updated. Chapter "Hardware" updated.
61	090120	TQ	Chapter "Working with J-Link" * Section "Cortex-M3 specific reset strategies"
60	090114	AG	Chapter "Working with J-Link" * Section "Cortex-M3 specific reset strategies"
59	090108	KN	Chapter Hardware * Section "Target board design for JTAG" updated. * Section "Target board design for SWD" added.
58	090105	AG	Chapter "Working with J-Link Pro" * Section "Connecting J-Link Pro the first time" updated.

Revision	Date	By	Explanation
57	081222	AG	Chapter "Working with J-Link Pro" * Section "Introduction" updated. * Section "Configuring J-Link Pro via web interface" updated. Chapter "Introduction" * Section "J-Link Pro overview" updated.
56	081219	AG	Chapter "Working with J-Link Pro" * Section "FAQs" added. Chapter "Support and FAQs" * Section "Frequently Asked Questions" updated.
55	081218	AG	Chapter "Hardware" updated.
54	081217	AG	Chapter "Working with J-Link and J-Trace" * Section "Command strings" updated.
53	081216	AG	Chapter "Working with J-Link Pro" updated.
52	081212	AG	Chapter "Working with J-Link Pro" added. Chapter "Licensing" * Section "Original SEGGER products" updated.
51	081202	KN	Several corrections.
50	081030	AG	Chapter "Flash download and flash breakpoints" * Section "Supported devices" corrected.
49	081029	AG	Several corrections.
48	080916	AG	Chapter "Working with J-Link and J-Trace" * Section "Connecting multiple J-Links / J-Traces to your PC" updated.
47	080910	AG	Chapter "Licensing" updated.
46	080904	AG	Chapter "Licensing" added. Chapter "Hardware" Section "J-Link OEM versions" moved to chapter "Licensing"
45	080902	AG	Chapter "Hardware" Section "JTAG+Trace connector" JTAG+Trace connector pinout corrected. Section "J-Link OEM versions" updated.
44	080827	AG	Chapter "J-Link control panel" moved to chapter "Working with J-Link". Several corrections.
43	080826	AG	Chapter "Flash download and flash breakpoints" Section "Supported devices" updated.
42	080820	AG	Chapter "Flash download and flash breakpoints" Section "Supported devices" updated.
41	080811	AG	Chapter "Flash download and flash breakpoints" updated. Chapter "Flash download and flash breakpoints", section "Supported devices" updated.
40	080630	AG	Chapter "Flash download and flash breakpoints" updated. Chapter "J-Link status window" renamed to "J-Link control panel" Various corrections.
39	080627	AG	Chapter "Flash download and flash breakpoints" Section "Licensing" updated. Section "Using flash download and flash breakpoints with different debuggers" updated. Chapter "J-Link status window" added.

Revision	Date	By	Explanation
38	080618	AG	Chapter "Support and FAQs" Section "Frequently Asked Questions" updated Chapter "Reset strategies" Section "Cortex-M3 specific reset strategies" updated.
37	080617	AG	Chapter "Reset strategies" Section "Cortex-M3 specific reset strategies" updated.
36	080530	AG	Chapter "Hardware" Section "Differences between different versions" updated. Chapter "Working with J-Link and J-Trace" Section "Cortex-M3 specific reset strategies" added.
35	080215	AG	Chapter "J-Link and J-Trace related software" Section "J-Link software and documentation package in detail" updated.
34	080212	AG	Chapter "J-Link and J-Trace related software" Section "J-Link TCP/IP Server (Remote J-Link / J-Trace use)" updated. Chapter "Working with J-Link and J-Trace" Section "Command strings" updated. Chapter "Flash download and flash breakpoints" Section "Introduction" updated. Section "Licensing" updated. Section "Using flash download and flash breakpoints with different debuggers" updated.
33	080207	AG	Chapter "Flash download and flash breakpoints" added Chapter "Device specifics": Section "ATMEL - AT91SAM7 - Recommended init sequence" added.
32	0080129	SK	Chapter "Device specifics": Section "NXP - LPC - Fast GPIO bug" list of device enhanced.
31	0080103	SK	Chapter "Device specifics": Section "NXP - LPC - Fast GPIO bug" updated.
30	071211	AG	Chapter "Device specifics": Section "Analog Devices" updated. Section "ATMEL" updated. Section "Freescale" added. Section "Luminary Micro" added. Section "NXP" updated. Section "OKI" added. Section "ST Microelectronics" updated. Section "Texas Instruments" updated. Chapter "Related software": Section "J-Link STR91x Commander" updated
29	070912	SK	Chapter "Hardware", section "Target board design" updated.
28	070912	SK	Chapter "Related software": Section "J-LinkSTR91x Commander" added. Chapter "Device specifics": Section "ST Microelectronics" added. Section "Texas Instruments" added. Subsection "AT91SAM9" added.

Revision	Date	By	Explanation
28	070912	AG	Chapter "Working with J-Link/J-Trace": Section "Command strings" updated.
27	070827	TQ	Chapter "Working with J-Link/J-Trace": Section "Command strings" updated.
26	070710	SK	Chapter "Introduction": Section "Features of J-Link" updated. Chapter "Background Information": Section "Embedded Trace Macrocell" added. Section "Embedded Trace Buffer" added.
25	070516	SK	Chapter "Working with J-Link/J-Trace": Section "Reset strategies in detail" - "Software, for Analog Devices ADuC7xxx MCUs" updated - "Software, for ATMEL AT91SAM7 MCUs" added. Chapter "Device specifics" Section "Analog Devices" added. Section "ATMEL" added.
24	070323	SK	Chapter "Setup": "Uninstalling the J-Link driver" updated. "Supported ARM cores" updated.
23	070320	SK	Chapter "Hardware": "Using the JTAG connector with SWD" updated.
22	070316	SK	Chapter "Hardware": "Using the JTAG connector with SWD" added.
21	070312	SK	Chapter "Hardware": "Differences between different versions" supplemented.
20	070307	SK	Chapter "J-Link / J-Trace related software": "J-Link GDB Server" licensing updated.
19	070226	SK	Chapter "J-Link / J-Trace related software" updated and reorganized. Chapter "Hardware" "List of OEM products" updated
18	070221	SK	Chapter "Device specifics" added Subchapter "Command strings" added
17	070131	SK	Chapter "Hardware": "Version 5.3": Current limits added "Version 5.4" added Chapter "Setup": "Installing the J-Link USB driver" removed. "Installing the J-Link software and documentation pack" added. Subchapter "List of OEM products" updated. "OS support" updated
16	061222	SK	Chapter "Preface": "Company description" added. J-Link picture changed.
15	060914	OO	Subchapter 1.5.1: Added target supply voltage and target supply current to specifications. Subchapter 5.2.1: Pictures of ways to connect J-Trace.
14	060818	TQ	Subchapter 4.7 "Using DCC for memory reads" added.
13	060711	OO	Subchapter 5.2.2: Corrected JTAG+Trace connector pinout table.
12	060628	OO	Subchapter 4.1: Added ARM966E-S to List of supported ARM cores.

Revision	Date	By	Explanation
11	060607	SK	Subchapter 5.5.2.2 changed. Subchapter 5.5.2.3 added.
10	060526	SK	ARM9 download speed updated. Subchapter 8.2.1: Screenshot "Start sequence" updated. Subchapter 8.2.2 "ID sequence" removed. Chapter "Support" and "FAQ" merged. Various improvements
9	060324	OO	Chapter "Literature and references" added. Chapter "Hardware": Added common information trace signals. Added timing diagram for trace. Chapter "Designing the target board for trace" added.
8	060117	OO	Chapter "Related Software": Added JLinkARM.dll. Screenshots updated.
7	051208	OO	Chapter Working with J-Link: Sketch added.
6	051118	OO	Chapter Working with J-Link: "Connecting multiple J-Links to your PC" added. Chapter Working with J-Link: "Multi core debugging" added. Chapter Background information: "J-Link firm-ware" added.
5	051103	TQ	Chapter Setup: "JTAG Speed" added.
4	051025	OO	Chapter Background information: "Flash programming" added. Chapter Setup: "Scan chain configuration" added. Some smaller changes.
3	051021	TQ	Performance values updated.
2	051011	TQ	Chapter "Working with J-Link" added.
1	050818	TW	Initial version.

About this document

This document describes J-Link and J-Trace. It provides an overview over the major features of J-Link and J-Trace, gives you some background information about JTAG, ARM and Tracing in general and describes J-Link and J-Trace related software packages available from Segger. Finally, the chapter *Support and FAQs* on page 307 helps to troubleshoot common problems.

For simplicity, we will refer to J-Link ARM as J-Link in this manual.

For simplicity, we will refer to J-link Pro as J-Link Pro in this manual.

Typographic conventions

This manual uses the following typographic conventions:

Style	Used for
Body	Body text.
Keyword	Text that you enter at the command-prompt or that appears on the display (that is system functions, file- or pathnames).
Reference	Reference to chapters, tables and figures or other documents.
GUIElement	Buttons, dialog boxes, menu names, menu commands.

Table 1.1: Typographic conventions



SEGGER Microcontroller GmbH & Co. KG develops and distributes software development tools and ANSI C software components (middleware) for embedded systems in several industries such as telecom, medical technology, consumer electronics, automotive industry and industrial automation.

SEGGER's intention is to cut software development time for embedded applications by offering compact flexible and easy to use middleware, allowing developers to concentrate on their application.

Our most popular products are emWin, a universal graphic software package for embedded applications, and embOS, a small yet efficient real-time kernel. emWin, written entirely in ANSI C, can easily be used on any CPU and most any display. It is complemented by the available PC tools: Bitmap Converter, Font Converter, Simulator and Viewer. embOS supports most 8/16/32-bit CPUs. Its small memory footprint makes it suitable for single-chip applications.

Apart from its main focus on software tools, SEGGER develops and produces programming tools for flash microcontrollers, as well as J-Link, a JTAG emulator to assist in development, debugging and production, which has rapidly become the industry standard debug probe for microcontrollers / microprocessors.

Corporate Office:

<http://www.segger.com>

United States Office:

<http://www.segger-us.com>

EMBEDDED SOFTWARE (Middleware)



emWin

Graphics software and GUI

emWin is designed to provide an efficient, processor- and display controller-independent graphical user interface (GUI) for any application that operates with a graphical display. Starterkits, eval- and trial-versions are available.



embOS

Real Time Operating System

embOS is an RTOS designed to offer the benefits of a complete multitasking system for hard real time applications with minimal resources. The profiling PC tool embOSView is included.



emFile

File system

emFile is an embedded file system with FAT12, FAT16 and FAT32 support. emFile has been optimized for minimum memory consumption in RAM and ROM while maintaining high speed. Various Device drivers, e.g. for NAND and NOR flashes, SD/MMC and CompactFlash cards, are available.



emUSB

USB device stack

A USB stack designed to work on any embedded system with a USB client controller. Bulk communication and most standard device classes are supported.

SEGGER TOOLS

Flasher

Flash programmer

Flash Programming tool primarily for microcontrollers.

J-Link

The de-facto standard debug probe

supporting multiple architectures and debug interfaces.

J-Trace

Debug probe with trace capabilities

J-Link with Trace memory, supporting the ARM ETM (Embedded Trace Macrocell).

J-Link / J-Trace Related Software

Add-on software to be used with SEGGER's industry standard JTAG emulator, this includes flash programming software and flash breakpoints.



Table of Contents

1	Introduction	21
1.1	Requirements.....	22
1.2	Supported OS	23
1.3	J-Link / J-Trace models	24
1.3.1	Model comparison.....	25
1.3.2	J-Link	26
1.3.3	J-Link ULTRA+	29
1.3.4	J-Link PRO.....	30
1.3.5	J-Link Lite ARM	31
1.3.6	J-Link Lite Cortex-M.....	32
1.3.7	J-Trace ARM	33
1.3.8	J-Trace for Cortex-M	36
1.3.9	Flasher ARM.....	38
1.3.10	J-Link ColdFire	39
1.4	Common features of the J-Link product family	40
1.5	Supported CPU cores	41
1.6	Built-in intelligence for supported CPU-cores	42
1.6.1	Intelligence in the J-Link firmware	42
1.6.2	Intelligence on the PC-side (DLL).....	42
1.6.3	Firmware intelligence per model	44
1.7	Supported IDEs	46
2	Licensing.....	47
2.1 Components requiring a license	48
2.2	License types	49
2.2.1	Built-in license	49
2.2.2	Key-based license.....	49
2.3	Legal use of SEGGER J-Link software.....	50
2.3.1	Use of the software with 3rd party tools.....	50
2.4	Original SEGGER products.....	51
2.4.1	J-Link	51
2.4.2	J-Link PLUS	51
2.4.3	J-link ULTRA+	52
2.4.4	J-Link PRO.....	52
2.4.5	J-Trace.....	53
2.4.6	J-Trace for Cortex-M	53
2.4.7	Flasher ARM.....	54
2.4.8	Flasher RX.....	54
2.4.9	Flasher PPC	55
2.5	J-Link OEM versions.....	56
2.5.1	Analog Devices: mIDASLink	56
2.5.2	Atmel: SAM-ICE	56
2.5.3	Digi: JTAG Link.....	57
2.5.4	IAR: J-Link / J-Link KS	57
2.5.5	IAR: J-Link Lite	57
2.5.6	IAR: J-Trace	58
2.5.7	NXP: J-Link Lite LPC Edition	58
2.5.8	SEGGER: J-Link Lite ARM.....	58
2.6	J-Link OBs	59
2.7	Illegal Clones	60

3	J-Link software and documentation package.....	61
3.1	Software overview.....	62
3.2	J-Link Commander (Command line tool).....	63
3.2.1	Command line options.....	63
3.2.2	Using command files.....	64
3.3	J-Link GDB Server.....	66
3.3.1	J-Link GDB Server CL (Windows, Lunux, Mac).....	66
3.3.2	Debugging with J-Link GDB Server.....	67
3.3.3	Supported remote (monitor) commands.....	72
3.3.4	SEGGER-specific GDB protocol extensions.....	84
3.3.5	Command line options.....	87
3.4	J-Link Remote Server.....	98
3.4.1	List of available commands.....	98
3.4.2	Tunneling mode.....	99
3.5	J-Mem Memory Viewer.....	102
3.6	J-Flash.....	103
3.7	J-Link SWO Viewer.....	104
3.7.1	Usage.....	105
3.7.2	List of available command line options.....	105
3.7.3	Configure SWO output after device reset.....	107
3.7.4	Target example code for terminal output.....	107
3.8	SWO Analyzer.....	110
3.9	JTAGLoad (Command line tool).....	111
3.10	J-Link RDI (Remote Debug Interface).....	112
3.10.1	Flash download and flash breakpoints.....	112
3.11	Processor specific tools.....	113
3.11.1	J-Link STR91x Commander (Command line tool).....	113
3.11.2	J-Link STM32 Unlock (Command line tool).....	114
3.12	J-Link Software Developer Kit (SDK).....	116
4	Setup.....	117
4.1	Installing the J-Link software and documentation pack.....	118
4.1.1	Setup procedure.....	118
4.2	Setting up the USB interface.....	121
4.2.1	Verifying correct driver installation.....	121
4.2.2	Uninstalling the J-Link USB driver.....	122
4.3	Setting up the IP interface.....	124
4.3.1	Configuring J-Link using J-Link Configurator.....	124
4.3.2	Configuring J-Link using the webinterface.....	124
4.4	FAQs.....	126
4.5	J-Link Configurator.....	127
4.5.1	Configure J-Links using the J-Link Configurator.....	127
4.6	J-Link USB identification.....	129
4.6.1	Connecting to different J-Links connected to the same host PC via USB.....	129
4.7	Using the J-Link DLL.....	131
4.7.1	What is the JLink DLL?.....	131
4.7.2	Updating the DLL in third-party programs.....	131
4.7.3	Determining the version of JLink DLL.....	132
4.7.4	Determining which DLL is used by a program.....	132
4.8	Getting started with J-Link and ARM DS-5.....	133
4.8.1	Replacing the RDDI DLL manually.....	133
4.8.2	Using J-Link in DS-5 Development Studio.....	133
5	Working with J-Link and J-Trace.....	135
5.1	Connecting the target system.....	136
5.1.1	Power-on sequence.....	136
5.1.2	Verifying target device connection.....	136
5.1.3	Problems.....	136
5.2	Indicators.....	137
5.2.1	Main indicator.....	137

5.2.2	Input indicator	139
5.2.3	Output indicator	139
5.3	JTAG interface.....	140
5.3.1	Multiple devices in the scan chain	140
5.3.2	Sample configuration dialog boxes	140
5.3.3	Determining values for scan chain configuration.....	143
5.3.4	JTAG Speed	144
5.4	SWD interface	145
5.4.1	SWD speed.....	145
5.4.2	SWO	145
5.5	Multi-core debugging	147
5.5.1	How multi-core debugging works	147
5.5.2	Using multi-core debugging in detail	148
5.5.3	Things you should be aware of	149
5.6	Connecting multiple J-Links / J-Traces to your PC	151
5.6.1	How does it work?	151
5.7	J-Link control panel.....	153
5.7.1	Tabs	153
5.8	Reset strategies	159
5.8.1	Strategies for ARM 7/9 devices.....	159
5.8.2	Strategies for Cortex-M devices	161
5.9	Using DCC for memory access	164
5.9.1	What is required?	164
5.9.2	Target DCC handler	164
5.9.3	Target DCC abort handler	164
5.10	J-Link script files	165
5.10.1	Actions that can be customized	165
5.10.2	Script file API functions	165
5.10.3	Global DLL variables	169
5.10.4	Global DLL constants.....	172
5.10.5	Script file language	173
5.10.6	Script file writing example	174
5.10.7	Executing J-Link script files	174
5.11	Command strings	176
5.11.1	List of available commands	176
5.11.2	Using command strings	181
5.12	Switching off CPU clock during debug	183
5.13	Cache handling.....	184
5.13.1	Cache coherency	184
5.13.2	Cache clean area	184
5.13.3	Cache handling of ARM7 cores.....	184
5.13.4	Cache handling of ARM9 cores.....	184
5.14	Virtual COM Port (VCOM)	185
5.14.1	Configuring Virtual COM Port	185
6	Flash download.....	187
6.1	Introduction.....	188
6.2	Licensing	189
6.3	Supported devices	190
6.4	Setup for various debuggers (internal flash)	191
6.4.1	IAR Embedded Workbench.....	191
6.4.2	Keil MDK	191
6.4.3	Mentor Sourcery CodeBench	194
6.4.4	J-Link GDB Server	194
6.4.5	J-Link Commander.....	195
6.4.6	J-Link RDI	196
6.5	Setup for various debuggers (CFI flash)	197
6.5.1	IAR Embedded Workbench / Keil MDK	197
6.5.2	J-Link GDB Server	198
6.5.3	J-Link commander	198
6.6	Using the DLL flash loaders in custom applications	200

7	Flash breakpoints.....	201
7.1	Introduction	202
7.2	Licensing.....	203
7.2.1	Free for evaluation and non-commercial use	203
7.3	Supported devices.....	204
7.4	Setup & compatibility with various debuggers	205
7.4.1	Setup	205
7.4.2	Compatibility with various debuggers	205
7.5	FAQ.....	206
8	RDI.....	207
8.1	Introduction	208
8.1.1	Features	208
8.2	Licensing.....	209
8.3	Setup for various debuggers	210
8.3.1	IAR Embedded Workbench IDE	210
8.3.2	ARM AXD (ARM Developer Suite, ADS)	213
8.3.3	ARM RVDS (RealView developer suite)	215
8.3.4	GHS MULTI	220
8.3.5	KEIL MDK (μ Vision IDE)	223
8.4	Configuration.....	226
8.4.1	Configuration file JLinkRDI.ini	226
8.4.2	Using different configurations	226
8.4.3	Using multiple J-Links simultaneously	226
8.4.4	Configuration dialog	226
8.5	Semihosting	235
8.5.1	Overview	235
8.5.2	The SWI interface	235
8.5.3	Implementation of semihosting in J-Link RDI	236
8.5.4	Semihosting with AXD.....	236
8.5.5	Unexpected / unhandled SWIs	237
9	Device specifics	239
9.1	Analog Devices	240
9.1.1	ADuC7xxx	240
9.2	ATMEL	242
9.2.1	AT91SAM7	243
9.2.2	AT91SAM9	245
9.3	DSPGroup	246
9.4	Ember	247
9.5	Energy Micro	248
9.6	Freescale	249
9.6.1	Kinetis family.....	249
9.7	Fujitsu	252
9.8	Itron	253
9.9	Infineon	254
9.10	Luminary Micro	255
9.10.1	Unlocking LM3Sxxx devices	256
9.11	NXP.....	257
9.11.1	LPC ARM7-based devices.....	258
9.11.2	Reset (Cortex-M3 based devices)	259
9.11.3	LPC288x flash programming	259
9.11.4	LPC43xx:	259
9.12	OKI	260
9.13	Renesas	261
9.14	Samsung	262
9.14.1	S3FN60D	262
9.15	Silicon Labs	263
9.15.1	EFM32 series devices	263
9.16	ST Microelectronics.....	264

9.16.1	STR91x	265
9.16.2	STM32F10xxx	265
9.16.3	STM32F2xxx	267
9.16.4	STM32F4xxx	268
9.17	Texas Instruments.....	269
9.17.1	AM335x.....	269
9.17.2	AM35xx / AM37xx.....	270
9.17.3	OMAP4430.....	270
9.17.4	OMAP-L138.....	270
9.17.5	TMS470M	270
9.17.6	OMAP3530.....	271
9.17.7	OMAP3550.....	271
9.18	Toshiba	272
10	Target interfaces and adapters	273
10.1	20-pin JTAG/SWD connector	274
10.1.1	Pinout for JTAG	274
10.1.2	Pinout for SWD.....	277
10.1.3	Pinout for SWD + Virtual COM Port (VCOM).....	279
10.2	38-pin Mictor JTAG and Trace connector	280
10.2.1	Connecting the target board.....	280
10.2.2	Pinout	281
10.2.3	Assignment of trace information pins between ETM architecture versions	283
10.2.4	Trace signals.....	283
10.3	19-pin JTAG/SWD and Trace connector.....	285
10.3.1	Target power supply	286
10.4	9-pin JTAG/SWD connector	287
10.5	Adapters	288
11	Background information	289
11.1	JTAG.....	290
11.1.1	Test access port (TAP).....	290
11.1.2	Data registers	290
11.1.3	Instruction register	290
11.1.4	The TAP controller	291
11.2	Embedded Trace Macrocell (ETM).....	293
11.2.1	Trigger condition	293
11.2.2	Code tracing and data tracing.....	293
11.2.3	J-Trace integration example - IAR Embedded Workbench for ARM	293
11.3	Embedded Trace Buffer (ETB)	297
11.4	Flash programming	298
11.4.1	How does flash programming via J-Link / J-Trace work?.....	298
11.4.2	Data download to RAM	298
11.4.3	Data download via DCC	298
11.4.4	Available options for flash programming	298
11.5	J-Link / J-Trace firmware	300
11.5.1	Firmware update	300
11.5.2	Invalidating the firmware.....	300
12	Designing the target board for trace	303
12.1	Overview of high-speed board design	304
12.1.1	Avoiding stubs	304
12.1.2	Minimizing Signal Skew (Balancing PCB Track Lengths).....	304
12.1.3	Minimizing Crosstalk	304
12.1.4	Using impedance matching and termination	304
12.2	Terminating the trace signal.....	305
12.2.1	Rules for series terminators	305
12.3	Signal requirements.....	306
13	Support and FAQs	307

13.1	Measuring download speed	308
13.1.1	Test environment	308
13.2	Troubleshooting	309
13.2.1	General procedure.....	309
13.2.2	Typical problem scenarios	309
13.3	Contacting support	311
13.4	Frequently Asked Questions.....	312
14	Glossary	313
15	Literature and references.....	319

Chapter 1

Introduction

This chapter gives a short overview about J-Link and J-Trace.

1.1 Requirements

Host System

To use J-Link or J-Trace you need a host system running Windows 2000 or later. For a list of all operating systems which are supported by J-Link, please refer to *Supported OS* on page 23.

Target System

A target system with a supported CPU is required. You should make sure that the emulator you are looking at supports your target CPU. For more information about which J-Link features are supported by each emulator, please refer to *Model comparison* on page 25.

1.2 Supported OS

J-Link/J-Trace can be used on the following operating systems:

- Microsoft Windows 2000
- Microsoft Windows XP
- Microsoft Windows XP x64
- Microsoft Windows Vista
- Microsoft Windows Vista x64
- Windows 7
- Windows 7 x64
- Windows 8
- Windows 8 x64
- Linux
- Mac OSX 10.5 and higher

1.3 J-Link / J-Trace models

J-Link / J-Trace is available in different variations, each designed for different purposes / target devices. Currently, the following models of J-Link / J-Trace are available:

- J-Link
- J-Link PLUS
- J-Link PRO
- J-Link ULTRA
- J-Link ULTRA+
- J-Trace ARM
- J-Trace for Cortex-M

In the following, the different J-Link / J-Trace models are described and the changes between the different hardware versions of each model are listed. To determine the hardware version of your J-Link / J-Trace, the first step should be to look at the label at the bottom side of the unit. J-Links / J-Traces have the hardware version printed on the back label.

If this is not the case with your J-Link / J-Trace, start `JLink.exe`. As part of the initial message, the hardware version is displayed.

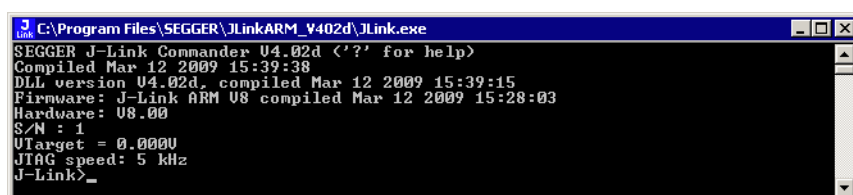

```
C:\Program Files\SEGGER\JLinkARM_V402d\JLink.exe
SEGGER J-Link Commander V4.02d ('?' for help)
Compiled Mar 12 2009 15:39:38
DLL version V4.02d, compiled Mar 12 2009 15:39:15
Firmware: J-Link ARM V8 compiled Mar 12 2009 15:28:03
Hardware: V8.00
S/N : 1
VTarget = 0.0000
JTAG speed: 5 kHz
J-Link>_
```

1.3.1 Model comparison

The following tables show the features which are included in each J-Link / J-Trace model.

Hardware features

	J-Link	J-Link Plus	J-Link ULTRA+	J-Link Pro	J-Trace for Cortex-M	J-Trace
USB	yes	yes	yes	yes	yes	yes
Ethernet	no	no	no	yes	no	no
Supported cores	ARM7/9/11, Cortex-A5/A8/A9/R4, Cortex-M0/M0+/M1/M3/M4, Renesas RX				Tracing: Cortex-M3/M4 No tracing: ARM7/9/11, Cortex-M0/M0+/ M1 Cortex-A5/A8/ A9/R4	ARM 7/9
JTAG	yes	yes	yes	yes	yes	yes
SWD	yes	yes	yes	yes	yes	no
SWO	yes	yes	yes	yes	yes	no
ETM Trace	no	no	no	no	yes	yes

Software features

Software features are features implemented in the software primarily on the host. Software features can either come with the J-Link or be added later using a license string from Segger.

	J-Link	J-Link PLUS	J-Link ULTRA+	J-Link Pro	J-Trace for Cortex-M	J-Trace
J-Flash	yes(opt)	yes	yes	yes	yes	yes
Flash breakpoints ²	yes(opt)	yes	yes	yes	yes	yes
Flash download ¹	yes	yes	yes	yes	yes	yes
GDB Server	yes	yes	yes	yes	yes	yes
RDI	yes(opt)	yes	yes	yes	yes	yes

¹ Most IDEs come with its own flashloaders, so in most cases this feature is not essential for debugging your applications in flash. The J-Link flash download (FlashDL) feature is mainly used in debug environments where the debugger does not come with an own flashloader (for example, the GNU Debugger). For more information about how flash download via FlashDL works, please refer to *Flash download* on page 187.

² In order to use the flash breakpoints with J-Link no additional license for flash download is required. The flash breakpoint feature allows setting an unlimited number of breakpoints even if the application program is not located in RAM, but in flash memory. Without this feature, the number of breakpoints which can be set in flash is limited to the number of hardware breakpoints (typically two for ARM 7/9, up to six for Cortex-M) For more information about flash breakpoints, please refer to *Flash breakpoints* on page 201.

1.3.2 J-Link

J-Link is a JTAG emulator designed for ARM cores. It connects via USB to a PC running Microsoft Windows 2000 or later. For a complete list of all operating systems which are supported, please refer to *Supported OS* on page 23. J-Link has a built-in 20-pin JTAG connector, which is compatible with the standard 20-pin connector defined by ARM.

1.3.2.1 Additional features

- Direct download into flash memory of most popular micro-controllers supported
- Full-speed USB 2.0 interface
- Serial Wire Debug supported
- Serial Wire Viewer supported
- Download speed up to 1 MBytes/second*
- Debug interface (JTAG/SWD/...) speed up to 15 MHz
- RDI interface available, which allows using J-Link with RDI compliant software

*The actual speed depends on various factors, such as JTAG/SWD, clock speed, host CPU core etc.



1.3.2.2 Specifications

The following table gives an overview about the specifications (general, mechanical, electrical) for J-Link.

General	
Supported OS	For a complete list of all operating systems which are supported, please refer to <i>Supported OS</i> on page 23.
Electromagnetic compatibility (EMC)	EN 55022, EN 55024
Operating temperature	+5°C ... +60°C
Storage temperature	-20°C ... +65 °C
Relative humidity (non-condensing)	Max. 90% rH
Mechanical	
Size (without cables)	100mm x 53mm x 27mm
Weight (without cables)	70g
Available interfaces	
USB interface	USB 2.0, full speed
Target interface	JTAG 20-pin (14-pin adapter available)
JTAG/SWD Interface, Electrical	
Power supply	USB powered Max. 50mA + Target Supply current.
Target interface voltage (V_{IF})	1.2V ... 5V
Target supply voltage	4.5V ... 5V (if powered with 5V on USB)
Target supply current	Max. 300mA
Reset Type	Open drain. Can be pulled low or tristated.
Reset low level output voltage (V_{OL})	$V_{OL} \leq 10\%$ of V_{IF}
For the whole target voltage range ($1.2V \leq V_{IF} \leq 5V$)	
LOW level input voltage (V_{IL})	$V_{IL} \leq 40\%$ of V_{IF}

Table 1.1: J-Link specifications

HIGH level input voltage (V_{IH})	$V_{IH} \geq 60\%$ of V_{IF}
For $1.8V \leq V_{IF} \leq 3.6V$	
LOW level output voltage (V_{OL}) with a load of 10 kOhm	$V_{OL} \leq 10\%$ of V_{IF}
HIGH level output voltage (V_{OH}) with a load of 10 kOhm	$V_{OH} \geq 90\%$ of V_{IF}
For $3.6 \leq V_{IF} \leq 5V$	
LOW level output voltage (V_{OL}) with a load of 10 kOhm	$V_{OL} \leq 20\%$ of V_{IF}
HIGH level output voltage (V_{OH}) with a load of 10 kOhm	$V_{OH} \geq 80\%$ of V_{IF}
JTAG/SWD Interface, Timing	
SWO sampling frequency	Max. 7.5 MHz
Data input rise time (T_{rdi})	$T_{rdi} \leq 20ns$
Data input fall time (T_{fdi})	$T_{fdi} \leq 20ns$
Data output rise time (T_{rdo})	$T_{rdo} \leq 10ns$
Data output fall time (T_{fdo})	$T_{fdo} \leq 10ns$
Clock rise time (T_{rc})	$T_{rc} \leq 3ns$
Clock fall time (T_{fc})	$T_{fc} \leq 3ns$

Table 1.1: J-Link specifications

1.3.2.3 Hardware versions

Versions 1-4 (Obsolete)

Obsolete.

Version 5.0 (Obsolete)

Identical to version 4.0 with the following exception:

- Uses a 32-bit RISC CPU.
- Maximum download speed (using DCC) is over 700 Kbytes/second.
- JTAG speed: Maximum JTAG frequency is 12 MHz; possible JTAG speeds are: 48 MHz / n, where n is 4, 5, ..., resulting in speeds of:
 - 12.000 MHz (n = 4)
 - 9.600 MHz (n = 5)
 - 8.000 MHz (n = 6)
 - 6.857 MHz (n = 7)
 - 6.000 MHz (n = 8)
 - 5.333 MHz (n = 9)
 - 4.800 MHz (n = 10)
- Supports adaptive clocking.

Version 5.2 (Obsolete)

Identical to version 5.0 with the following exception:

- Target interface: RESET is open drain

Version 5.3 (Obsolete)

Identical to version 5.2 with the following exception:

- 5V target supply current limited
5V target supply (pin 19) of Kick-Start versions of J-Link is current monitored and limited. J-Link automatically switches off 5V supply in case of over-current to protect both J-Link and host computer. Peak current (≤ 10 ms) limit is 1A, operating current limit is 300mA.

Version 5.4 (Obsolete)

Identical to version 5.3 with the following exception:

- Supports 5V target interfaces.

Version 6.0 (Obsolete)

Identical to version 5.4 with the following exception:

- Outputs can be tristated (Effectively disabling the JTAG interface)
- Supports SWD interface.
- SWD speed: Software implementation. 4 MHz maximum SWD speed.
- J-Link supports SWV (Speed limited to 500 kHz)

Version 7.0 (Obsolete)

Identical to version 6.0 with the following exception:

- Uses an additional pin to the UART unit of the target hardware for SWV support (Speed limited to 6 MHz).

Version 8.0

Identical to version 7.0 with the following exception:

- SWD support for non-3.3V targets.

Version 9.1

- New design based on STM32F205.

Version 9.2

Identical to version 9.1 with the following exception:

- Pin 1 (VTref) is used for measuring target reference voltage only. Buffers on J-Link side are no longer powered through this pin but via the J-Link internal voltage supplied via USB.

1.3.3 J-Link ULTRA+

J-Link ULTRA+ is a JTAG/SWD emulator designed for ARM/Cortex and other supported CPUs. It is fully compatible to the standard J-Link and works with the same PC software. Based on the highly optimized and proven J-Link, it offers even higher speed as well as target power measurement capabilities due to the faster CPU, built-in FPGA and High speed USB interface. It connects via USB to a PC running Microsoft Windows 2000 or later. For a complete list of all operating systems which are supported, please refer to Supported OS on page 19.. J-link ULTRA has a built-in 20-pin JTAG/SWD connector.



1.3.3.1 Additional features

- Fully compatible to the standard J-Link
- Very high performance for all supported CPU cores
- Hi-Speed USB 2.0 interface
- Download speed up to 3 MByte/second*
- Debug interface (JTAG/SWD/...) speed up to 15 MHz
- Serial Wire Debug (SWD) supported
- Serial Wire Viewer (SWV) supported
- SWO sampling frequencies up to 100 MHz
- Serial Wire Output (SWO) supported
- Target power can be supplied
- Target power consumption can be measured with high accuracy.

*The actual speed depends on various factors, such as JTAG/SWD, clock speed, host CPU core etc.

1.3.3.2 Specifications

The following table gives an overview about the specifications (general, mechanical, electrical) for J-link ULTRA. All values are valid for J-link ULTRA hardware version 1.

Note: Some specifications, especially speed, are likely to be improved in the future with newer versions of the J-Link software (freely available).

General	
Supported OS	For a complete list of all operating systems which are supported, please refer to <i>Supported OS</i> on page 23.
Electromagnetic compatibility (EMC)	EN 55022, EN 55024
Operating temperature	+5°C ... +60°C
Storage temperature	-20°C ... +65 °C
Relative humidity (non-condensing)	Max. 90% rH
Mechanical	
Size (without cables)	100mm x 53mm x 27mm
Weight (without cables)	73g
Available interfaces	
USB interface	USB 2.0, Hi-Speed
Target interface	20-pin J-Link debug interface connector
JTAG/SWD Interface, Electrical	
Target interface voltage (V_{IF})	1.8V ... 5V
Target supply voltage	4.5V ... 5V
Target supply current	Max. 300mA

Table 1.2: J-link ULTRA specifications

Reset Type	Open drain. Can be pulled low or tristated.
Reset low level output voltage (V_{OL})	$V_{OL} \leq 10\%$ of V_{IF}
For the whole target voltage range ($1.8V \leq V_{IF} \leq 5V$)	
LOW level input voltage (V_{IL})	$V_{IL} \leq 40\%$ of V_{IF}
HIGH level input voltage (V_{IH})	$V_{IH} \geq 60\%$ of V_{IF}
For $1.8V \leq V_{IF} \leq 3.6V$	
LOW level output voltage (V_{OL}) with a load of 10 kOhm	$V_{OL} \leq 10\%$ of V_{IF}
HIGH level output voltage (V_{OH}) with a load of 10 kOhm	$V_{OH} \geq 90\%$ of V_{IF}
For $3.6 \leq V_{IF} \leq 5V$	
LOW level output voltage (V_{OL}) with a load of 10 kOhm	$V_{OL} \leq 20\%$ of V_{IF}
HIGH level output voltage (V_{OH}) with a load of 10 kOhm	$V_{OH} \geq 80\%$ of V_{IF}
JTAG/SWD Interface, Timing	
SWO sampling frequency	Max. 100 MHz
Data input rise time (T_{rdi})	$T_{rdi} \leq 20ns$
Data input fall time (T_{fdi})	$T_{fdi} \leq 20ns$
Data output rise time (T_{rdo})	$T_{rdo} \leq 10ns$
Data output fall time (T_{fdo})	$T_{fdo} \leq 10ns$
Clock rise time (T_{rc})	$T_{rc} \leq 3ns$
Clock fall time (T_{fc})	$T_{fc} \leq 3ns$
Analog power measurement interface	
Sampling frequency	50 kHz
Resolution	1 mA

Table 1.2: J-link ULTRA specifications

1.3.4 J-Link PRO

J-Link PRO is a JTAG emulator designed for ARM cores. It is fully compatible to J-Link and connects via Ethernet/USB to a PC running Microsoft Windows 2000 or later, Linux or Mac OS X. For a complete list of all operating systems which are supported, please refer to Supported OS on page 19. J-Link Pro comes with licenses for all J-Link related SEGGER software products which allows using J-Link PRO "out-of-the-box".

1.3.4.1 Additional features

- Fully compatible to J-Link
- More memory for future firmware extensions (ARM11, X-Scale, Cortex R4 and Cortex A8)
- Additional LEDs for power and RESET indication
- Comes with web interface for easy TCP/IP configuration (built-in web server)
- Serial Wire Debug supported
- Serial Wire Viewer supported
- Download speed up to 3 MByte/second
- Comes with built-in licenses for: Unlimited number of breakpoints in flash (FlashBP), J-Link GDBServer, J-Link RDI and J-Flash (production programming software).
- Embedded Trace Buffer (ETB) support



- Galvanic isolation from host via Ethernet

1.3.4.2 Hardware versions

Version 1.1

Compatible to J-Link.

- Provides an additional Ethernet interface which allows to communicate with J-Link via TCP/IP.

Version 4

- New design based on STM32F407 + FPGA (Cyclone IV) Version 4.3

Identical to version 4 with the following exception:

- Pin 1 (VTref) is used for measuring target reference voltage only. Buffers on J-Link side are no longer powered through this pin but via the J-Link internal voltage supplied via USB.

1.3.5 J-Link Lite ARM

J-Link Lite ARM is a fully functional OEM-version of J-Link. If you are selling evaluation-boards, J-Link Lite ARM is an inexpensive emulator solution for you. Your customer receives a widely acknowledged JTAG-emulator which allows him to start right away with his development.



1.3.5.1 Additional features

- Very small form factor
- Fully software compatible to J-Link
- Supports any ARM7/9/11, Cortex-A5/A8/A9, Cortex-M0/M0+/M1/M3/M4, Cortex-R4/R5 core
- JTAG clock up to 4 MHz
- SWD, SWO supported for Cortex-M devices
- Flash download into supported MCUs
- Standard 20-pin 0.1 inch JTAG connector (compatible to J-Link)

1.3.5.2 Specifications

The following table gives an overview about the specifications (general, mechanical, electrical) for J-Link Lite ARM. All values are valid for J-Link hardware version 8.

General	
Supported OS	For a complete list of all operating systems which are supported, please refer to <i>Supported OS</i> on page 23.
Electromagnetic compatibility (EMC)	EN 55022, EN 55024
Operating temperature	+5°C ... +60°C
Storage temperature	-20°C ... +65 °C
Relative humidity (non-condensing)	Max. 90% rH
Size (without cables)	28mm x 26mm x 7mm
Weight (without cables)	6g
Mechanical	
USB interface	USB 2.0, full speed
Target interface	JTAG 20-pin (14-pin adapter available)
JTAG/SWD Interface, Electrical	

Table 1.3: J-Link Lite specifications

Power supply	USB powered Max. 50mA + Target Supply current.
Target interface voltage (V_{IF})	3.3V
Target supply voltage	4.5V ... 5V (if powered with 5V on USB)
Target supply current	Max. 300mA
LOW level input voltage (V_{IL})	Max. 40% of V_{IF}
HIGH level input voltage (V_{IH})	Min. 60% of V_{IF}
JTAG/SWD Interface, Timing	
Data input rise time (T_{rdi})	Max. 20ns
Data input fall time (T_{fdi})	Max. 20ns
Data output rise time (T_{rdo})	Max. 10ns
Data output fall time (T_{fdo})	Max. 10ns
Clock rise time (T_{rc})	Max. 10ns
Clock fall time (T_{fc})	Max. 10ns

Table 1.3: J-Link Lite specifications

1.3.6 J-Link Lite Cortex-M

J-Link Lite Cortex-M is a specific OEM-version of SEGGER J-Link Lite which is designed to be used with Cortex-M devices. If you are selling evaluation-boards, J-Link Lite CortexM is an inexpensive emulator solution for you. Your customer receives a widely acknowledged JTAG/SWD-emulator which allows him to start right away with his development.



- Very small form factor
- Fully software compatible to J-Link
- Any Cortex-M0/M0+/M1/M3/M4 core supported
- JTAG clock up to 4 MHz
- SWD, SWO supported
- Flash download into supported MCUs
- Standard 9- or 19-pin 0.05" Samtec FTSH connector
- 3.3V target interface voltage

1.3.6.1 Specifications

The following table gives an overview about the specifications (general, mechanical, electrical) for J-Link Lite Cortex-M.

General	
Supported OS	For a complete list of all operating systems which are supported, please refer to <i>Supported OS</i> on page 23.
Electromagnetic compatibility (EMC)	EN 55022, EN 55024
Operating temperature	+5°C ... +60°C
Storage temperature	-20°C ... +65 °C
Relative humidity (non-condensing)	Max. 90% rH
Size (without cables)	41mm x 34mm x 8mm
Weight (without cables)	6g
Mechanical	
USB interface	USB 2.0, full speed
Target interface	19-pin 0.05" Samtec FTSH connector 9-pin 0.05" Samtec FTSH connector
JTAG/SWD Interface, Electrical	

Table 1.4: J-Link Lite Cortex-M specifications

Power supply	USB powered Max. 50mA + Target Supply current.
Target interface voltage (V_{IF})	3.3V
Target supply voltage	4.5V ... 5V
Target supply current	Max. 300mA
LOW level input voltage (V_{IL})	Max. 40% of V_{IF}
HIGH level input voltage (V_{IH})	Min. 60% of V_{IF}
JTAG/SWD Interface, Timing	
Data input rise time (T_{rdi})	Max. 20ns
Data input fall time (T_{fdi})	Max. 20ns
Data output rise time (T_{rdo})	Max. 10ns
Data output fall time (T_{fdo})	Max. 10ns
Clock rise time (T_{rc})	Max. 10ns
Clock fall time (T_{fc})	Max. 10ns

Table 1.4: J-Link Lite Cortex-M specifications

1.3.7 J-Trace ARM

J-Trace is a JTAG emulator designed for ARM cores which includes trace (ETM) support. It connects via USB to a PC running Microsoft Windows 2000 or later. For a complete list of all operating systems which are supported, please refer to Supported OS on page 19. J-Trace has a built-in 20-pin JTAG connector and a built in 38-pin JTAG+Trace connector, which are compatible to the standard 20-pin connector and 38-pin connector defined by ARM.



1.3.7.1 Additional features

- Supports tracing on ARM7/9 targets
- JTAG speed up to 12 MHz
- Download speed up to 420 Kbytes/second *
- DCC speed up to 600 Kbytes/second *

* = Measured with J-Trace, ARM7 @ 50 MHz, 12MHz JTAG speed.

1.3.7.2 Specifications for J-Trace

General	
Supported OS	For a complete list of all operating systems which are supported, please refer to <i>Supported OS</i> on page 23.
Electromagnetic Compatibility (EMC)	EN 55022, EN 55024
Operating Temperature	+5°C ... +40°C
Storage Temperature	-20°C ... +65 °C
Relative Humidity (non-condensing)	<90% rH
Size (without cables)	123mm x 68mm x 30mm
Weight (without cables)	120g
Mechanical	
USB Interface	USB 2.0, full speed
Target Interface	JTAG 20-pin (14-pin adapter available) JTAG+Trace: Mictor, 38-pin

Table 1.5: J-Trace specifications

JTAG/SWD Interface, Electrical	
Power Supply	USB powered < 300mA
Supported Target interface voltage	3.0 - 3.6 V (5V adapter available)

Table 1.5: J-Trace specifications

1.3.7.3 Download speed

The following table lists performance values (Kbytes/s) for writing to memory (RAM):

Hardware	ARM7 via JTAG	ARM9 via JTAG
J-Trace Rev. 1	420.0 Kbytes/s (12MHz JTAG)	280.0 Kbytes/s (12MHz JTAG)

Table 1.6: Download speed differences between hardware revisions

All tests have been performed in the testing environment which is described on *Measuring download speed* on page 308.

The actual speed depends on various factors, such as JTAG, clock speed, host CPU core etc.

1.3.7.4 Hardware versions

Version 1

This J-Trace uses a 32-bit RISC CPU. Maximum download speed is approximately 420 KBytes/second (600 KBytes/second using DCC).

1.3.8 J-Trace for Cortex-M

J-Trace for Cortex-M is a JTAG/SWD emulator designed for Cortex-M cores which includes trace (ETM) support. J-Trace for Cortex-M can also be used as a J-Link and it also supports ARM7/9 cores. Tracing on ARM7/9 targets is not supported.



1.3.8.1 Additional features

- Has all the J-Link functionality
- Supports tracing on Cortex-M targets

1.3.8.2 Specifications

The following table gives an overview about the specifications (general, mechanical, electrical) for J-Trace for Cortex-M. All values are valid for the latest hardware version of J-Trace for Cortex-M.

General	
Supported OS	For a complete list of all operating systems which are supported, please refer to Supported OS on page 19.
Electromagnetic compatibility (EMC)	EN 55022, EN 55024
Operating temperature	+5°C ... +60°C
Storage temperature	-20°C ... +65 °C
Relative humidity (non-condensing)	Max. 90% rH
Size (without cables)	123mm x 68mm x 30mm
Weight (without cables)	120g
Mechanical	
USB interface	USB 2.0, Hi-Speed
Target interface	JTAG/SWD 20-pin (14-pin adapter available) JTAG/SWD + Trace 19-pin
JTAG/SWD Interface, Electrical	
Power supply	USB powered Max. 50mA + Target Supply current.
Target interface voltage (V_{IF})	1.2V ... 5V
Target supply voltage	4.5V ... 5V (if powered with 5V on USB)
Target supply current	Max. 300mA
LOW level input voltage (V_{IL})	Max. 40% of V_{IF}
HIGH level input voltage (V_{IH})	Min. 60% of V_{IF}
JTAG/SWD Interface, Timing	
Data input rise time (T_{rdi})	Max. 20ns
Data input fall time (T_{fdi})	Max. 20ns
Data output rise time (T_{rdo})	Max. 10ns
Data output fall time (T_{fdo})	Max. 10ns
Clock rise time (T_{rc})	Max. 3ns

Table 1.7: J-Trace for Cortex-M3 specifications

Clock fall time (T_{fc})	Max. 3ns
Trace Interface, Electrical	
Power supply	USB powered Max. 50mA + Target Supply current.
Target interface voltage (V_{IF})	1.2V ... 5V
Voltage interface low pulse (V_{IL})	Max. 40% of V_{IF}
Voltage interface high pulse (V_{IH})	Min. 60% of V_{IF}
Trace Interface, Timing	
TRACECLK low pulse width (T_{wl})	Min. 2ns
TRACECLK high pulse width (T_{wh})	Min. 2ns
Data rise time (T_{rd})	Max. 3ns
Data fall time (T_{fd})	Max. 3ns
Clock rise time (T_{rc})	Max. 3ns
Clock fall time (T_{fc})	Max. 3ns
Data setup time (T_s)	Min. 3ns
Data hold time (T_h)	Min. 2ns

Table 1.7: J-Trace for Cortex-M3 specifications

1.3.8.3 Download speed

The following table lists performance values (Kbytes/s) for writing to memory (RAM):

Hardware	Cortex-M3
J-Trace for Cortex-M3 V2	190 Kbytes/s (12MHz SWD) 760 KB/s (12 MHz JTAG)
J-Trace for Cortex-M V3.1	190 Kbytes/s (12MHz SWD) 1440 KB/s (25 MHz JTAG)

Table 1.8: Download speed differences between hardware revisions

The actual speed depends on various factors, such as JTAG, clock speed, host CPU core etc.

1.3.8.4 Hardware versions

Version 2

Obsolete.

Version 3.1

Identical to version 2.0 with the following exceptions:

- Hi-Speed USB
- Voltage range for trace signals extended to 1.2 - 3.3 V
- Higher download speed

1.3.9 Flasher ARM

Flasher ARM is a programming tool for microcontrollers with on-chip or external Flash memory and ARM core. Flasher ARM is designed for programming flash targets with the J-Flash software or stand-alone. In addition to that Flasher ARM has all of the J-Link functionality. For more information about Flasher ARM, please refer to *UM08007, Flasher ARM User's Guide*.

1.3.9.1 Specifications

The following table gives an overview about the specifications (general, mechanical, electrical) for Flasher ARM.



General	
Supported OS	For a complete list of all operating systems which are supported, please refer to Supported OS on page 19.
Mechanical	
USB interface	USB 2.0, full speed
Target interface	JTAG/SWD 20-pin
JTAG Interface, Electrical	
Power supply	USB powered Max. 50mA + Target Supply current.
Target interface voltage (V_{IF})	1.2V ... 5V
Target supply voltage	4.5V ... 5V (if powered with 5V on USB)
Target supply current	Max. 300mA
For the whole target voltage range ($1.8V \leq V_{IF} \leq 5V$)	
LOW level input voltage (V_{IL})	Max. 40% of V_{IF}
HIGH level input voltage (V_{IH})	Min. 60% of V_{IF}
For $1.8V \leq V_{IF} \leq 3.6V$	
LOW level output voltage (V_{OL}) with a load of 10 kOhm	Max. 10% of V_{IF}
HIGH level output voltage (V_{OH}) with a load of 10 kOhm	Min. 90% of V_{IF}
For $3.6 \leq V_{IF} \leq 5V$	
LOW level output voltage (V_{OL}) with a load of 10 kOhm	Max. 20% of V_{IF}
HIGH level output voltage (V_{OH}) with a load of 10 kOhm	Min. 80% of V_{IF}
SWD Interface, Electrical	
Power supply	USB powered Max. 50mA + Target Supply current.
Target interface voltage (V_{IF})	1.2V ... 5V (SWD interface is 5V tolerant but can output a maximum of 3.3V SWD signals)
Target supply voltage	4.5V ... 5V (if powered with 5V on USB)

Table 1.9: Flasher ARM specifications

Target supply current	Max. 300mA
LOW level input voltage (V_{IL})	Max. 0.8V
HIGH level input voltage (V_{IH})	Min. 2.0V
LOW level output voltage (V_{OL}) with a load of 10 kOhm	Max. 0.5V
HIGH level output voltage (V_{OH}) with a load of 10 kOhm	Min. 2.85V

Table 1.9: Flasher ARM specifications

1.3.10 J-Link ColdFire

J-Link ColdFire is a BDM emulator designed for ColdFire® cores. It connects via USB to a PC running Microsoft Windows 2000, Windows XP, Windows 2003, or Windows Vista. J-Link ColdFire has a built-in 26-pin BDM connector, which is compatible to the standard 26-pin connector defined by Freescale. For more information about J-Link ColdFire BDM 26, please refer to *UM08009, J-Link ColdFire BDM26 User's Guide*.



1.4 Common features of the J-Link product family

- USB 2.0 interface (Full-Speed/Hi-Speed, depends on J-Link model)
- Any ARM7/9/11 (including thumb mode), Cortex-A5/A8, Cortex-M0/M1/M3/M4, Cortex-R4 core supported
- Automatic core recognition
- Maximum JTAG speed 12/25 MHz (depends on J-Link model)
- Seamless integration into the IAR Embedded Workbench® IDE
- No power supply required, powered through USB
- Support for adaptive clocking
- All JTAG signals can be monitored, target voltage can be measured
- Support for multiple devices
- Fully plug and play compatible
- Standard 20-pin JTAG/SWD connector, 19-pin JTAG/SWD and Trace connector, standard 38-pin JTAG+Trace connector
- USB and 20-pin ribbon cable included
- Memory viewer (J-Mem) included
- Remote server included, which allows using J-Trace via TCP/IP networks
- RDI interface available, which allows using J-Link with RDI compliant software
- Flash programming software (J-Flash) available
- Flash DLL available, which allows using flash functionality in custom applications
- Software Developer Kit (SDK) available
- Full integration with the IAR C-SPY® debugger; advanced debugging features available from IAR C-SPY debugger.
- 14-pin JTAG adapter available
- J-Link 19-pin Cortex-M Adapter available
- J-Link 9-pin Cortex-M Adapter available
- Adapter for 5V JTAG targets available for hardware revisions up to 5.3
- Optical isolation adapter for JTAG/SWD interface available
- Target power supply via pin 19 of the JTAG/SWD interface (up to 300 mA to target with overload protection), alternatively on pins 11 and 13 of the Cortex-M 19-pin trace connector

1.5 Supported CPU cores

J-Link / J-Trace has been tested with the following cores, but should work with any ARM7/9/11, Cortex-M0/M1/M3/M4 and Cortex-A5/A8/A9/R4 core. If you experience problems with a particular core, do not hesitate to contact Segger.

- ARM7TDMI (Rev 1)
- ARM7TDMI (Rev 3)
- ARM7TDMI-S (Rev 4)
- ARM720T
- ARM920T
- ARM922T
- ARM926EJ-S
- ARM946E-S
- ARM966E-S
- ARM1136JF-S
- ARM1136J-S
- ARM1156T2-S
- ARM1156T2F-S
- ARM1176JZ-S
- ARM1176JZF
- ARM1176JZF-S
- Cortex-A5
- Cortex-A8
- Cortex-A9
- Cortex-M0
- Cortex-M1
- Cortex-M3
- Cortex-M4
- Cortex-R4
- Renesas RX

1.6 Built-in intelligence for supported CPU-cores

In general, there are two ways to support a CPU-core in the J-Link software:

1. Intelligence in the J-Link firmware
2. Intelligence on the PC-side (DLL)

Having the intelligence in the firmware is ideal since it is much more powerful and robust. The J-Link PC software automatically detects which implementation level is supported for the connected CPU-core. If Intelligence in the firmware is available, it is used. If you are using a J-Link that does not have intelligence in the firmware and only PC-side intelligence is available for the connected CPU, a warning message is shown.

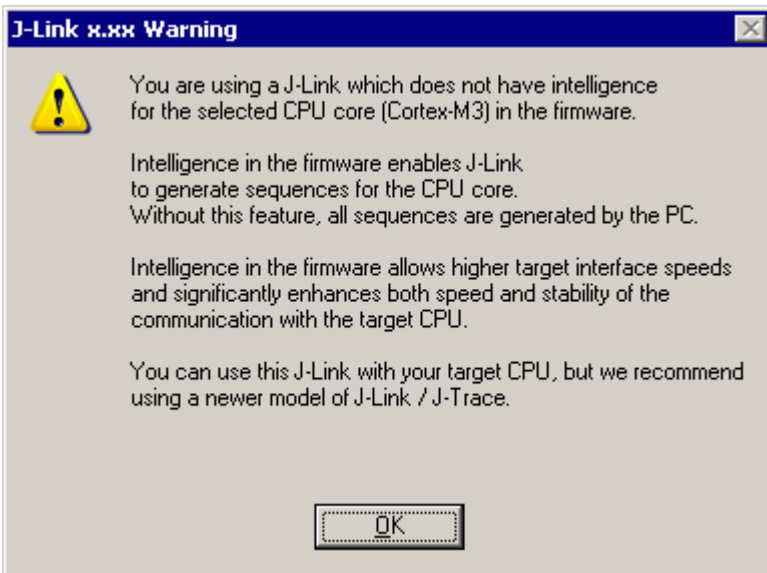

1.6.1 Intelligence in the J-Link firmware

On newer J-Links, the intelligence for a new CPU-core is also available in the J-Link firmware which means, for these J-Links the target sequences are no longer generated on the PC-side but directly inside the J-Link. Having the intelligence in the firmware leads to improved stability and higher performance.

1.6.2 Intelligence on the PC-side (DLL)

This is the basic implementation level for support of a CPU-core. This implementation is not J-Link model dependend, since no intelligence for the CPU-core is necessary in the J-Link firmware. This means, all target sequences (JTAG/SWD/...) are generated on the PC-side and the J-Link simply sends out these sequences and sends the result back to the DLL. Using this way of implementation also allows old J-Links to be used with new CPU cores as long as a DLL-Version is used which has intelligence for the CPU.

But there is one big disadvantage of implementing the CPU core support on the DLL-side: For every sequence which shall be send to the target a USB or Ethernet transaction is triggered. The long latency especially on a USB connection significantly affects the performance of J-Link. This is true especially, when performing actions where J-Link has to wait for the CPU frequently. An example is a memory read/write operation which needs to be followed by status read operations or repeated until the memory operation is completed. Performing this kind of task with only PC-side intelligence will have to either make some assumption like: Operation is completed after a given number of cycles or will have to make a lot of USB/Ethernet transactions. The first option (fast mode) will not work under some circumstances such as low CPU speeds, the second (slow mode) will be more reliable but very slow due to the high number of USB/Ethernet transactions. It simply boils down to: The best solution is having intelligence in the emulator itself!

1.6.2.1 Limitations of PC-side implementations

- **Instability, especially on slow targets**
Due to the fact that a lot of USB transactions would cause a very bad performance of J-Link, on PC-side implementations the assumption is made that the CPU/Debug interface is fast enough to handle the commands/requests without the need of waiting. So, when using the PC-side-intelligence, stability can not be guaranteed in all cases, especially if the target interface speed (JTAG/SWD/...) is significantly higher than the CPU speed.
- **Poor performance**
Since a lot more data has to be transferred over the host interface (typ. USB), the resulting download speed is typically much lower than for implementations with intelligence in the firmware, even if the number of transactions over the host interface is limited to a minimum (fast mode).
- **No support**
Please understand that we can not give any support if you are running into problems when using a PC-side implementation.

Note: Due to these limitations, we recommend to use PC-side implementations for evaluation only.

1.6.3 Firmware intelligence per model

There are different models of J-Link / J-Trace which have built-in intelligence for different CPU-cores. In the following, we will give you an overview about which model of J-Link / J-Trace has intelligence for which CPU-core.

1.6.3.1 Current models

The table below lists the firmware CPU support for J-Link & J-Trace models currently available.

J-Link / J-Trace model	Version	ARM 7/9	ARM 11	Cortex-A/R	Cortex-M		Renesas RX600
		JTAG	JTAG	JTAG	JTAG	SWD	JTAG
J-Link	8	✓	✓	✓	✓	✓	✓
J-Link Pro	3	✓	✓	✓	✓	✓	✓
J-link ULTRA	1	✓	✓	✓	✓	✓	✓
J-Link Lite ARM	8	✓	✓	✓	✓	✓	✗
J-Link Lite Cortex-M	8	✗	✗	✗	✓	✓	✗
J-Link Lite RX	8	✗	✗	✗	✗	✗	✓
J-Trace ARM	1	✓	✗	✗	✗	✗	✗
J-Trace for Cortex-M	3	✗	✗	✗	✓	✓	✗

Table 1.10: Built-in intelligence of current J-Links

1.6.3.2 Older models

The table below lists the firmware CPU support for older J-Link & J-Trace models which are not sold anymore.

J-Link / J-Trace model	Version	ARM 7/9	ARM 11	Cortex-A/R	Cortex-M		Renesas RX600
		JTAG	JTAG	JTAG	JTAG	SWD	JTAG
J-Link	3	✗	✗	✗	✗	not supported	✗
J-Link	4	✗	✗	✗	✗	not supported	✗
J-Link	5	✓	✗	✗	✗	not supported	✗
J-Link	6	✓	✗	✗	✗	✓	✗
J-Link	7	✓	✗	✗	✗	✓	✗
J-Link Pro	1	✓	✓	✓	✓	✓	✓
J-Trace for Cortex-M	1	✗	✗	✓	✓	✓	✗

Table 1.11: Built-in intelligence of older J-Link models

1.7 Supported IDEs

J-Link / J-Trace can be used with different IDEs. Some IDEs support J-Link directly, for other ones additional software (such as J-Link RDI) is necessary in order to use J-Link. The following tables list which features of J-Link / J-Trace can be used with the different IDEs.

ARM7/9

IDE	Debug support ⁴	Flash download	Flash breakpoints	Trace support ³
IAR EWARM	yes	yes	yes	yes
Keil MDK	yes	yes	yes	no
Rowley	yes	yes	no	no
CodeSourcery	yes	no	no	no
Yargato (GDB)	yes	yes	yes	no
RDI compliant toolchains such as RVDS/ADS	yes ¹	yes ¹	yes ¹	no

ARM Cortex-M3

IDE	Debug support ⁴	Flash download	Flash breakpoints	Trace support ³	SWO support
IAR EWARM	yes	yes	yes	yes	yes
Keil MDK	yes	yes	yes	yes	yes
Rowley	yes	yes	no	no	no
CodeSourcery	yes	no	no	no	no
Yargato (GDB)	yes	yes	yes	no	no

ARM11

ARM11 has currently been tested with IAR EWARM only.

IDE	Debug support ⁴	Flash download	Flash breakpoints	Trace support ³
IAR EWARM	yes	no ²	no ²	no
Rowley	yes	no ²	no	no
Yargato (GDB)	yes	no ²	no ²	no

¹ Requires J-Link RDI license for download of more than 32KBytes

² Coming soon

³ Requires emulator with trace support

⁴ Debug support includes the following: Download to RAM, memory read/write, CPU register read/write, Run control (go, step, halt), software breakpoints in RAM and hardware breakpoints in flash memory.

Chapter 2

Licensing

This chapter describes the different license types of J-Link related software and the legal use of the J-Link software with original SEGGER and OEM products.

2.1 Components requiring a license

The following programs/features require a full-featured J-Link (PLUS, ULTRA+, PRO, J-Trace) or an additional license for the J-Link base model:

- J-Flash
- J-Link RDI
- Flash breakpoints (FlashBP)

2.2 License types

For each of the software components which require an additional license, there are different types of licenses which are explained in the following.

Built-in License

This type of license is easiest to use. The customer does not need to deal with a license key. The software automatically finds out that the connected J-Link contains the built-in license(s). The license is burned into the J-Link debug probe and can be used on any computer, the J-Link is connected to. This type of license applies to the J-Link PLUS, J-Link ULTRA+ and J-Link Pro.

Key-based license

This type of license is used if you already have a J-Link, but order a license for a J-Link software component at a later time. In addition to that, the key-based license is used for trial licenses. To enable this type of license you need to obtain a license key from SEGGER. Free trial licenses are available upon request from www.segger.com. This license key has to be added to the J-Link license management. How to enter a license key is described in detail in *Licensing* on page 203. Every license can be used on different PCs, but only with the J-Link the license is for. This means that if you want to use flash breakpoints with other J-Links, every J-Link needs a license. This means that for example if you want to use the unlimited breakpoints in flash memory feature with different J-Links which do not come with a built-in license, a license is needed for each of these J-Links.

2.2.1 Built-in license

This type of license is easiest to use. The customer does not need to deal with a license key. The software automatically finds out that the connected J-Link contains the built-in license(s). To check what licenses the used J-Link have, simply open the J-Link commander (JLink.exe). The J-Link commander finds and lists all of the J-Link's licenses automatically, as can be seen in the screenshot below.

```

C:\Windows\system32\cmd.exe
SEGGER J-Link Commander 04.80 ('?' for help)
Compiled Dec 20 2013 19:38:02
DLL version 04.80, compiled Dec 20 2013 19:37:53
Firmware: J-Link 09 compiled Dec 11 2013 19:48:51
Hardware: U9_00
ID: 50200006
Feature(s): GDB, RDI, FlashBP, FlashDL, JFlash
Target - S-2800
Info: Found SWD-DP with ID 0x2BA01477
Info: Found Cortex-M4 r0p1, Little endian.
Info: FPUUnit: 6 code <BP> slots and 2 literal slots
Info: TPIU fitted.
Info: ETM fitted.
Found 1 JTAG device, Total IRLen = 4:
Cortex-M4 identified.
Target interface speed: 100 kHz
J-Link>_

```

The J-Link PLUS in the example above contains licenses for all features. Note that GDB and FlashDL feature are no longer required.

2.2.2 Key-based license

When using a key-based license, a license key is required in order to enable the feature. License keys can be added via the J-Link License Manager. How to enter a license via the license manager is described in *Licensing* on page 203. Like the built-in license, the key-based license is only valid for one J-Link, so if another J-Link is used it needs a separate license.

2.3 Legal use of SEGGER J-Link software

The software consists of proprietary programs of SEGGER, protected under copyright and trade secret laws. All rights, title and interest in the software are and shall remain with SEGGER. For details, please refer to the license agreement which needs to be accepted when installing the software. The text of the license agreement is also available as entry in the start menu after installing the software.

Use of software

SEGGER J-Link software may only be used with original SEGGER products and authorized OEM products. The use of the licensed software to operate SEGGER product clones is prohibited and illegal.

2.3.1 Use of the software with 3rd party tools

For simplicity, some components of the J-Link software are also distributed from partners with software tools designed to use J-Link. These tools are primarily debugging tools, but also memory viewers, flash programming utilities but also software for other purposes. Distribution of the software components is legal for our partners, but the same rules as described above apply for their usage: They may only be used with original SEGGER products and authorized OEM products. The use of the licensed software to operate SEGGER product clones is prohibited and illegal.

2.4 Original SEGGER products

The following products are original SEGGER products for which the use of the J-Link software is allowed:

2.4.1 J-Link

J-Link is a JTAG emulator designed for ARM cores. It connects via USB to a PC running Microsoft Windows 2000, Windows XP, Windows 2003, Windows Vista or Windows 7. J-Link has a built-in 20-pin JTAG connector, which is compatible with the standard 20-pin connector defined by ARM.

Licenses

Comes with built-in licenses for flash download.



2.4.2 J-Link PLUS



J-Link PLUS is a USB powered JTAG emulator supporting a large number of CPU cores.

Based on a 32-bit RISC CPU, it can communicate at high speed with the supported target CPUs. J-Link is used around the world in tens of thousand places for development and production (flash programming) purposes.

J-Link is supported by all major IDEs such as IAR EWARM, Keil MDK, Rowley CrossWorks, Atollic TrueSTUDIO, IAR EWRX, Renesas HEW, Renesas e2studio, and many others.

Licenses

Comes with licenses for: Unlimited breakpoints in flash memory (Unlimited Flash Breakpoints), RDI and J-Flash

2.4.3 J-link ULTRA+

J-link ULTRA+ is a JTAG/SWD emulator designed for ARM/Cortex and other supported CPUs. It is fully compatible to the standard J-Link and works with the same PC software. Based on the highly optimized and proven J-Link, it offers even higher speed as well as target power measurement capabilities due to the faster CPU, built-in FPGA and High speed USB interface. It connects via USB to a PC running Microsoft Windows 2000, Windows XP, Windows 2003, Windows Vista or Windows 7. J-link ULTRA has a built-in 20-pin JTAG/SWD connector.

Licenses

Unlimited breakpoints in flash memory (Unlimited Flash Breakpoints), RDI and J-Flash



2.4.4 J-Link PRO



J-Link PRO is a JTAG emulator designed for ARM cores. It connects via USB or Ethernet to a PC running Microsoft Windows 2000, Windows XP, Windows 2003, Windows Vista or Windows 7. J-Link has a built-in 20-pin JTAG connector, which is compatible with the standard 20-pin connector defined by ARM.

Licenses

Comes with built-in licenses for all J-Link related software products: J-Link FlashDL, FlashBP, RDI, J-Link GDB Server and J-Flash.

2.4.5 J-Trace

J-Trace is a JTAG emulator designed for ARM cores which includes trace (ETM) support. It connects via USB to a PC running Microsoft Windows 2000, Windows XP, Windows 2003, Windows Vista or Windows 7. J-Trace has a built-in 20-pin JTAG connector and a built in 38-pin JTAG+Trace connector, which is compatible with the standard 20-pin connector and 38-pin connector defined by ARM.

Licenses

Comes with built-in licenses for flash download.



2.4.6 J-Trace for Cortex-M



J-Trace for Cortex-M is a JTAG/SWD emulator designed for Cortex-M cores which include trace (ETM) support. J-Trace for Cortex-M can also be used as a regular J-Link and it also supports ARM7/9 cores. Please note that tracing on ARM7/9 targets is not supported by J-Trace for Cortex-M. In order to use ETM trace on ARM7/9 targets, a J-Trace is needed.

Licenses

Comes with built-in licenses for flash download.

2.4.7 Flasher ARM

Flasher ARM is a programming tool for microcontrollers with on-chip or external Flash memory and ARM core. Flasher ARM is designed for programming flash targets with the J-Flash software or stand-alone. In addition to that Flasher ARM has all of the J-Link functionality. Flasher ARM connects via USB or via RS232 interface to a PC, running Microsoft Windows 2000, Windows XP, Windows 2003 or Windows Vista. Flasher ARM has a built-in 20-pin JTAG connector, which is compatible with the standard 20-pin connector defined by ARM.

Licenses

Comes with built-in licenses for flash download and J-Flash.



2.4.8 Flasher RX



Flasher RX is a programming tool for Renesas RX600 series microcontrollers with on-chip or external flash memory and Renesas RX core. Flasher RX is designed for programming flash targets with the J-Flash software or stand-alone. In addition to that Flasher RX has all of the J-Link RX functionality. Flasher RX connects via Ethernet, USB or via RS232 interface to a PC, running Microsoft Windows 2000, Windows XP, Windows 2003, Windows Vista or Windows 7.

Flasher RX itself has a built-in 20-pin JTAG connector but is shipped with an 14-pin adapter for Renesas RX devices.

Licenses

Comes with built-in licenses for flash download and J-Flash.

2.4.9 Flasher PPC

Flasher ARM is a programming tool for microcontrollers with on-chip or external Flash memory and ARM core. Flasher ARM is designed for programming flash targets with the J-Flash software or stand-alone. In addition to that Flasher ARM has all of the J-Link functionality. Flasher ARM connects via USB or via RS232 interface to a PC, running Microsoft Windows 2000, Windows XP, Windows 2003 or Windows Vista. Flasher ARM has a built-in 20-pin JTAG connector, which is compatible with the standard 20-pin connector defined by ARM.

Licenses

Comes with built-in licenses for flash download and J-Flash.



2.5 J-Link OEM versions

There are several different OEM versions of J-Link on the market. The OEM versions look different, but use basically identical hardware. Some of these OEM versions are limited in speed, some of these can only be used with certain chips and some of these have certain add-on features enabled, which normally requires license. In any case, it should be possible to use the J-Link software with these OEM versions. However, proper function cannot be guaranteed for OEM versions. SEGGER Microcontroller does not support OEM versions; support is provided by the respective OEM.

2.5.1 Analog Devices: mIDASLink

mIDASLink is an OEM version of J-Link, sold by Analog Devices.

Limitations

mIDASLink works with Analog Devices chips only. This limitation can NOT be lifted; if you would like to use J-Link with a device from an other manufacturer, you need to buy a separate J-Link.

Licenses

Licenses for RDI, J-Link FlashDL and FlashBP are included. Other licenses can be added.



2.5.2 Atmel: SAM-ICE

SAM-ICE is an OEM version of J-Link, sold by Atmel.

Limitations

SAM-ICE works with Atmel devices only. This limitation can NOT be lifted; if you would like to use J-Link with a device from an other manufacturer, you need to buy a separate J-Link.

Licenses

Licenses for RDI and GDB Server are included. Other licenses can be added.



2.5.3 Digi: JTAG Link

Digi JTAG Link is an OEM version of J-Link, sold by Digi International.

Limitations

Digi JTAG Link works with Digi devices only. This limitation can NOT be lifted; if you would like to use J-Link with a device from an other manufacturer, you need to buy a separate J-Link.

Licenses

License for GDB Server is included. Other licenses can be added.



2.5.4 IAR: J-Link / J-Link KS

IAR J-Link / IAR J-Link KS are OEM versions of J-Link, sold by IAR.

Limitations

IAR J-Link / IAR J-Link KS can not be used with Keil MDK. This limitation can NOT be lifted; if you would like to use J-Link with Keil MDK, you need to buy a separate J-Link. IAR J-Link does not support kickstart power.

Licenses

No licenses are included. All licenses can be added.



2.5.5 IAR: J-Link Lite

IAR J-Link Lite is an OEM version of J-Link, sold by IAR.

Limitations

IAR J-Link Lite can not be used with Keil MDK. This limitation can NOT be lifted; if you would like to use J-Link with Keil MDK, you need to buy a separate J-Link.

JTAG speed is limited to 4 MHz.

Licenses

No licenses are included. All licenses can be added.

Note: IAR J-Link is only delivered and supported as part of Starter-Kits. It is not sold to end customer directly and not guaranteed to work with custom hardware.



2.5.6 IAR: J-Trace

IAR J-Trace is an OEM version of J-Trace, sold by IAR.

Limitations

IAR J-Trace can not be used with Keil MDK. This limitation can NOT be lifted; if you would like to use J-Trace with Keil MDK, you need to buy a separate J-Trace.

Licenses

No licenses are included. All licenses can be added.



2.5.7 NXP: J-Link Lite LPC Edition

J-Link Lite LPC Edition is an OEM version of J-Link, sold by NXP.

Limitations

J-Link Lite LPC Edition only works with NXP devices. This limitation can NOT be lifted; if you would like to use J-Link with a device from an other manufacturer, you need to buy a separate J-Link.

Licenses

No licenses are included.



2.5.8 SEGGER: J-Link Lite ARM

J-Link Lite ARM is a fully functional OEM-version of SEGGER J-Link. If you are selling evaluation-boards, J-Link Lite ARM is an inexpensive emulator solution for you. Your customer receives a widely acknowledged JTAG-emulator which allows him to start right away with his development.

Limitations

JTAG speed is limited to 4 MHz

Licenses

No licenses are included. All licenses can be added.

Note

J-Link Lite ARM is only delivered and supported as part of Starter Kits. It is not sold to end customer and not guaranteed to work with custom hardware.



2.6 J-Link OBs

J-Link OBs (J-Link On Board) are single chip versions of J-Link which are used on various evalboards. It is legal to use J-Link software with these boards.

2.7 Illegal Clones

Clones are copies of SEGGER products which use the copyrighted SEGGER Firmware without a license. It is strictly prohibited to use SEGGER J-Link software with illegal clones of SEGGER products. Manufacturing and selling these clones is an illegal act for various reasons, amongst them trademark, copyright and unfair business practise issues.

The use of illegal J-Link clones with this software is a violation of US, European and other international laws and is prohibited.

If you are in doubt if your unit may be legally used with SEGGER J-Link software, please get in touch with us.

End users may be liable for illegal use of J-Link software with clones.

Chapter 3

J-Link software and documentation package

This chapter describes the contents of the J-Link software and documentation package which can be downloaded from *www.segger.com*.

3.1 Software overview

The J-Link software and documentation package, which is available for download from <http://www.segger.com/jlink-software.html> includes some applications to be used with J-Link. It also comes with USB-drivers for J-Link and documentations in pdf format.

Software	Description
JLink Commander	Command-line tool with basic functionality for target analysis.
J-Link GDB Server	The J-Link GDB Server is a server connecting to the GNU Debugger (GDB) via TCP/IP. It is required for toolchains using the GDB protocol to connect to J-Link.
J-Link GDB Server command line version	Command line version of the J-Link GDB Server. Same functionality as the GUI version.
J-Link Remote Server	Utility which provides the possibility to use J-Link / J-Trace remotely via TCP/IP.
J-Mem Memory Viewer	Target memory viewer. Shows the memory content of a running target and allows editing as well.
J-Flash ^a	Stand-alone flash programming application. For more information about J-Flash please refer to <i>J-Flash ARM User's Guide (UM08003)</i> .
J-Link SWO Viewer	Free-of-charge utility for J-Link. Displays the terminal output of the target using the SWO pin. Can be used in parallel with a debugger or stand-alone.
J-Link SWO Analyzer	Command line tool that analyzes SWO RAW output and stores it into a file.
JTAGLoad	Command line tool that opens an <code>svf</code> file and sends the data in it via J-Link / J-Trace to the target.
J-Link Configurator	GUI-based configuration tool for J-Link. Allows configuration of USB identification as well as TCP/IP identification of J-Link. For more information about the J-Link Configurator, please refer to <i>J-Link Configurator</i> on page 127.
RDI support ^a	Provides Remote Debug Interface (RDI) support. This allows the user to use J-Link with any RDI-compliant debugger.
Processor specific tools	Free command-line tools for handling specific processors. Included are: STR9 Commander and STM32 Unlock.

Table 3.1: J-Link / J-Trace related software

a. Full-featured J-Link (PLUS, PRO, ULTRA+) or an additional license for J-Link base model required.

3.2 J-Link Commander (Command line tool)

J-Link Commander (JLink.exe) is a tool that can be used for verifying proper installation of the USB driver and to verify the connection to the target CPU, as well as for simple analysis of the target system. It permits some simple commands, such as memory dump, halt, step, go etc. to verify the target connection.

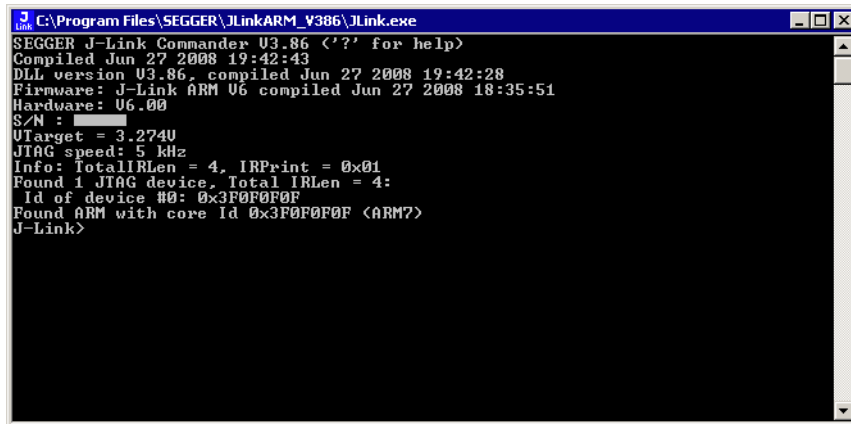

```

C:\Program Files\SEGGER\JLinkARM_V386\JLink.exe
SEGGER J-Link Commander V3.86 <'?' for help>
Compiled Jun 27 2008 19:42:43
DLL version V3.86, compiled Jun 27 2008 19:42:28
Firmware: J-Link ARM U6 compiled Jun 27 2008 18:35:51
Hardware: U6.00
S/N : 
UTarget = 3.274U
JTAG speed: 5 kHz
Info: TotalIRLen = 4, IRPrint = 0x01
Found 1 JTAG device, Total IRLen = 4:
  Id of device #0: 0x3F0F0F0F
Found ARM with core Id 0x3F0F0F0F <ARM7>
J-Link>
  
```

3.2.1 Command line options

J-Link Commander can be started with different command line options for test and automation purposes. In the following, the command line options which are available for J-Link Commander are explained.

-CommandFile

Selects a command file and starts J-Link Commander in batch mode. The batch mode of J-Link Commander is similar to the execution of a batch file. The command file is parsed line by line and one command is executed at a time.

Syntax

```
-CommanderScript <CommandFilePath>
```

Example

See *Using command files* on page 64

-Device

Pre-selects the device J-Link Commander shall connect to. For some devices, J-Link already needs to know the device at the time of connecting, since special handling is required for some of them. For a list of all supported device names, please refer to http://www.segger.com/jlink_supported_devices.html.

Syntax

```
-Device <DeviceName>
```

Example

```
JLink.exe -Device STM32F103ZE
```

-If

Selects the target interface J-Link shall use to connect to the target. By default, J-Link Commander first tries to connect to the target using the target interface which is currently selected in the J-Link firmware. If connecting fails, J-Link Commander goes through all target interfaces supported by the connected J-Link and tries to connect to the device.

Syntax

```
-If <TargetInterface>
```

Example

```
JLink.exe -If SWD
```

Additional information

Currently, the following target interfaces are supported:

- JTAG
- SWD

-IP

Selects IP as host interface to connect to J-Link. Default host interface is USB.

Syntax

```
-IP <IPAddr>
```

Example

```
JLink.exe -IP 192.168.1.17
```

Additional information

To select from a list of all available emulators on Ethernet, please use * as <IPAddr>.

-SelectEmuBySN

Connect to a J-Link with a specific serial number via USB. Useful if multiple J-Links are connected to the same PC and multiple instances of J-Link Commander shall run and each connects to another J-Link.

Syntax

```
-SelectEmuBySN <SerialNo>
```

Example

```
JLink.exe -SelectEmuBySN 580011111
```

-Speed

Starts J-Link Commander with a given initial speed. Available parameters are "adaptive", "auto" or a freely selectable integer value in kHz. It is recommended to use either a fixed speed or, if it is available on the target, adaptive speeds. Default interface speed is 100kHz.

Syntax

```
-Speed <Speed_kHz>
```

Example

```
JLink.exe -Speed 4000
```

3.2.2 Using command files

J-Link commander can also be used in batch mode which allows the user to use J-Link commander for batch processing and without user interaction. Please do not confuse command file with J-Link script files (please refer to *J-Link script files* on page 165 for more information about J-Link script files). When using J-Link commander in batch mode, the path to a command file is passed to it. The syntax in the command file is the same as when using regular commands in J-Link commander (one line per command).

Example

```
JLink.exe -CommanderScript C:\CommandFile.jlink
```

Contents of CommandFile.jlink:

```
r
h
exec device = STM32F103ZE
loadbin C:\firmware.bin,0x08000000
```

3.3 J-Link GDB Server

The GNU Project Debugger (GDB) is a freely available and open source debugger. It can be used in command line mode, but is also integrated in many IDEs like emIDE or Eclipse.

J-Link GDB Server is a remote server for GDB making it possible for GDB to connect to and communicate with the target device via J-Link. GDB Server and GDB communicate via a TCP/IP connection, using the standard GDB remote protocol. GDB Server receives the GDB commands, does the J-Link communication and replies with the answer to GDB.

With J-Link GDB Server debugging in ROM and Flash of the target device is possible and the Unlimited Flash Breakpoints can be used.

It also comes with some functionality not directly implemented in the GDB. These can be accessed via monitor commands, sent directly via GDB, too.

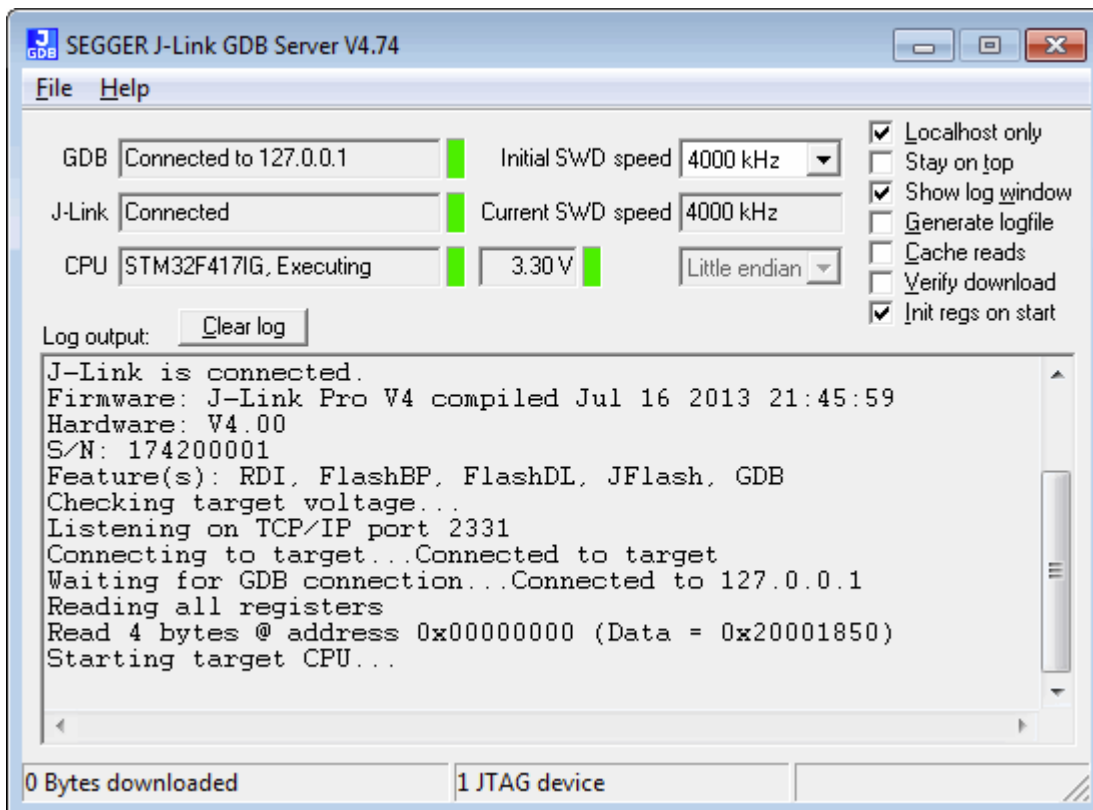

The GNU Project Debugger (GDB) is a freely available debugger, distributed under the terms of the GPL. The latest Unix version of the GDB is freely available from the GNU committee under: <http://www.gnu.org/software/gdb/download/>

J-Link GDB Server is distributed free of charge.

3.3.1 J-Link GDB Server CL (Windows, Linux, Mac)

J-Link GDB Server CL is a commandline-only version of the GDB Server. The command line version is part of the Software and Documentation Package and also included in the Linux and MAC versions.

Except for the missing GUI, J-Link GDB Server CL is identical to the normal version. All sub-chapters apply to the command line version, too.

3.3.2 Debugging with J-Link GDB Server

With J-Link GDB Server programs can be debugged via GDB directly on the target device like a normal application. The application can be loaded into RAM or flash of the device.

Before starting GDB Server make sure a J-Link and the target device are connected.

3.3.2.1 Setting up GDB Server GUI version

The GUI version of GDB Server is part of the Windows J-Link Software Package (JLinkGDBServer.exe).

When starting GDB Server a configuration dialog pops up letting you select the needed configurations to connect to J-Link and the target.

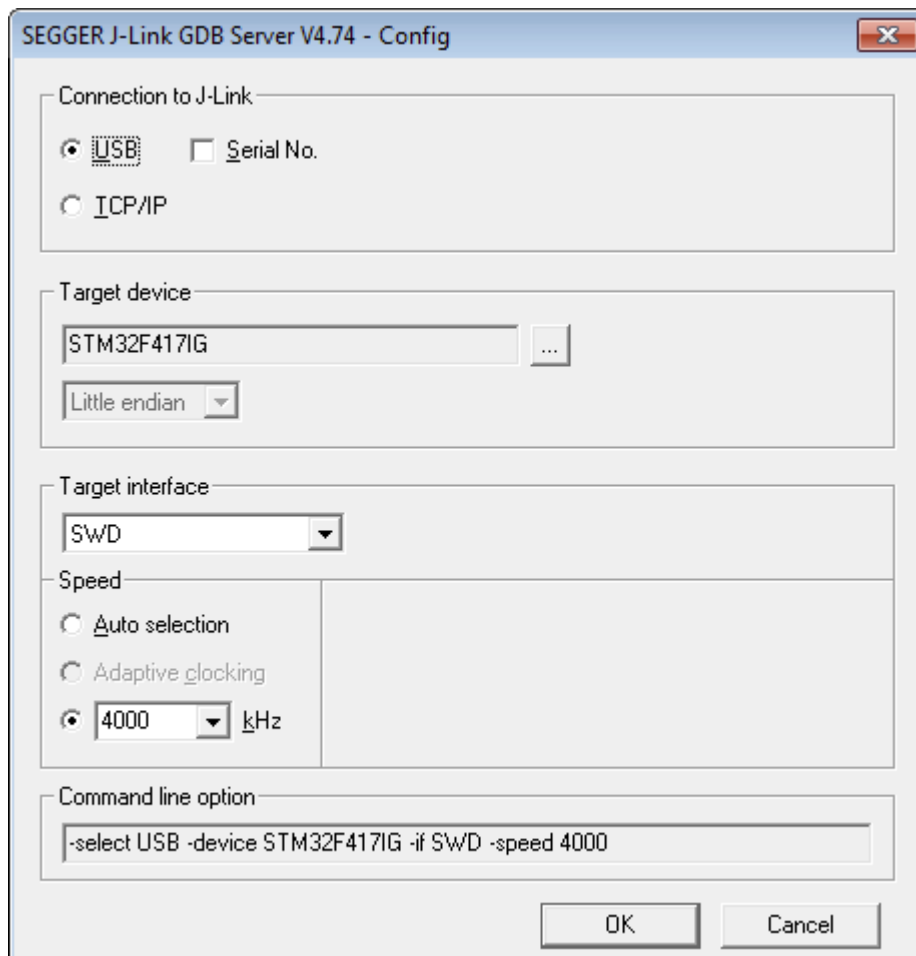

All configurations can optionally be given in the command line options.

Note: To make sure the connection to the target device can be established correctly, the device, as well as the interface and interface speed have to be given on start of GDB Server, either via command line options or the configuration dialog. If the target device option (`-device`) is given, the configuration dialog will not pop up.

3.3.2.2 Setting up GDB Server CL version

The command line version of GDB Server is part of the J-Link Software Package for all supported platforms.

On Windows its name is JLinkGDBServerCL.exe, on Linux and Mac it is JLinkGDB-Server.

Starting GDB Server on Windows

To start GDB Server CL on Windows, open the 'Run' prompt (Windows-R) or a command terminal (cmd) and enter `<PathToJLinkSoftware>\JLinkGDBServerCL.exe <CommandLineOptions>`.

Starting GDB Server on Linux / Mac

To start GDB Server CL on Linux / Mac, open a terminal and call `JLinkGDBServer <CommandLineOptions>`

Command Line Options

When using GDB Server CL, at least the mandatory command line options have to be given. Additional command line options can be given to change the default behavior of GDB Server.

For more information about the available command line options, please refer to *Command line options* on page 87.

3.3.2.3 GDB Server user interface

The J-Link GDB Server's user interface shows information about the debugging process and the target and allows some in progress configurations.

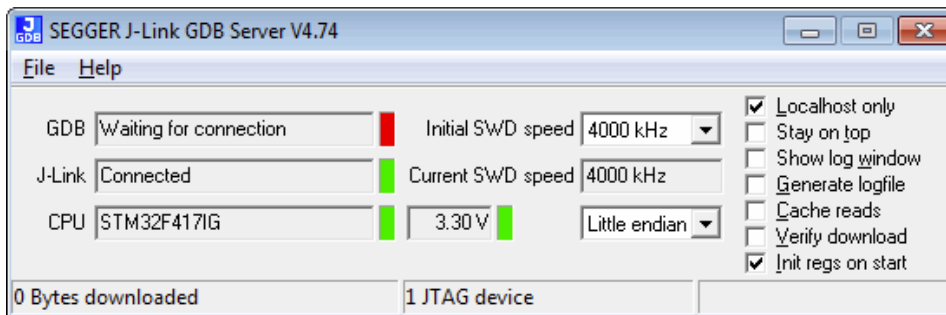

It shows following information:

- IP address of host running debugger.
- Connection status of J-Link.
- Information about the target core.
- Measured target voltage.
- Bytes that have been downloaded
- Status of target.
- Log output of the GDB Server (optional, if Show log window is checked).
- Initial and current target interface speed.
- Target endianness.

These configurations can be made from inside GDB Server:

- Localhost only: If checked only connections from 127.0.0.1 are accepted.
- Stay on top
- Show log window
- Generate logfile: If checked, a log file with the GDB <-> GDB Server <-> J-Link communication will be created.
- Verify download: If checked, the memory on the target will be verified after download.
- Init regs on start: If checked, the register values of the target will be set to a reasonable value before on start of GDB Server.

3.3.2.4 Running GDB from different programs

We assume that you already have a solid knowledge of the software tools used for building your application (assembler, linker, C compiler) and especially the debugger and the debugger frontend of your choice. We do not answer questions about how to install and use the chosen toolchain.

GDB is included in many IDEs and most commonly used in connection with the GCC compiler toolchain. This chapter shows how to configure some programs to use GDB and connect to GDB Server. For more information about any program using GDB, please refer to its user manual.

emIDE

emIDE is a full-featured, free and open source IDE for embedded development including support for debugging with J-Link.

To connect to GDB Server with emIDE, the GDB Server configurations need to be set in the project options at Project -> Properties... -> Debugger.

Select the target device you are using, the target connection, endianness and speed and enter the additional GDB start commands.

The typically required GDB commands are:

```
#Initially reset the target
monitor reset
#Load the application
load
```

Other commands to set up the target (e.g. Set PC to RAM, initialize external flashes) can be entered here, too.

emIDE will automatically start GDB Server on start of the debug session. If it does not, or an older version of GDB Server start, in emIDE click on JLink -> Run the JLink-plugin configuration.

The screenshot below shows an debug session in IDE. For download and more information about emIDE, please refer to <http://emide.org>.

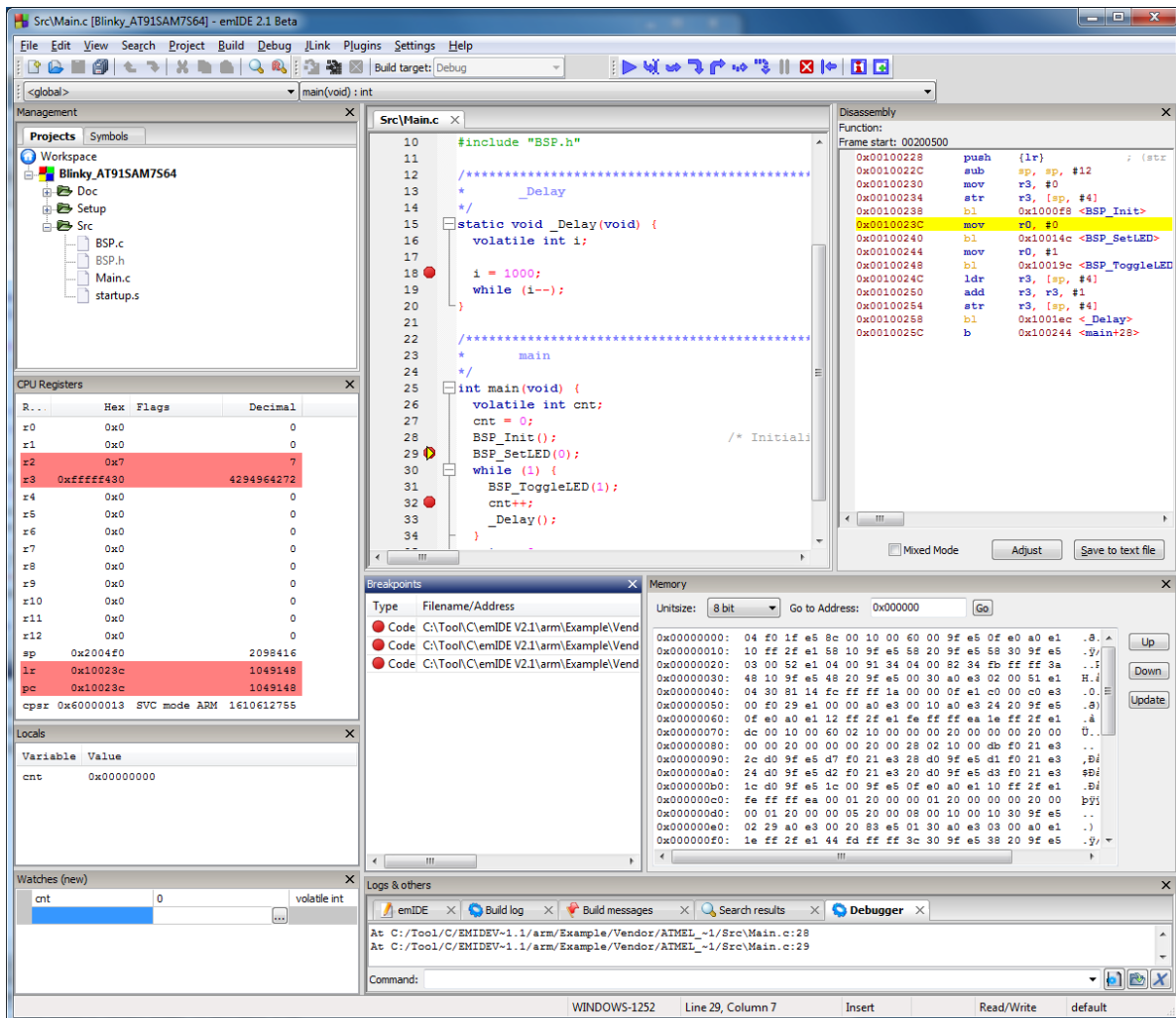

Console

GDB can be used stand-alone as a console application.

To connect GDB to GDB Server enter `target remote localhost:2331` into the running GDB. Within GDB all GDB commands and the remote monitor commands are available. For more information about debugging with GDB refer to its online manual available at <http://sourceware.org/gdb/current/onlinedocs/gdb/>.

A typical startup of a debugging session can be like:

```

(gdb) file C:/temp/Blinky.elf
Reading symbols from C:/temp/Blinky.elf...done.
(gdb) target remote localhost:2331
Remote debugging using localhost:2331
0x00000000 in ?? ()
(gdb) monitor reset
Resetting target
(gdb) load
Loading section .isr_vector, size 0x188 lma 0x8000000
Loading section .text, size 0x568 lma 0x8000188
Loading section .init_array, size 0x8 lma 0x80006f0
Loading section .fini_array, size 0x4 lma 0x80006f8
Loading section .data, size 0x428 lma 0x80006fc
Start address 0x8000485, load size 2852
Transfer rate: 146 KB/sec, 570 bytes/write.
(gdb) break main
Breakpoint 1 at 0x800037a: file Src\main.c, line 38.
(gdb) continue
Continuing.

Breakpoint 1, main () at Src\main.c:38
38      Cnt = 0;
(gdb)

```

Eclipse (CDT)

Eclipse is an open source platform-independent software framework, which has typically been used to develop integrated development environment (IDE). Therefore Eclipse can be used as C/C++ IDE, if you extend it with the CDT plug-in (<http://www.eclipse.org/cdt/>).

CDT means "C/C++ Development Tooling" project and is designed to use the GDB as default debugger and works without any problems with the GDB Server.

Refer to <http://www.eclipse.org> for detailed information about Eclipse.

Note: We only support problems directly related to the GDB Server. Problems and questions related to your remaining toolchain have to be solved on your own.

3.3.3 Supported remote (monitor) commands

J-Link GDB Server comes with some functionality which are not part of the standard GDB. These functions can be called either via a gdbinit file passed to GDB Server or via monitor commands passed directly to GDB, forwarding them to GDB Server.

To indicate to GDB to forward the command to GDB Server 'monitor' has to be prepended to the call. For example a reset can be triggered in the gdbinit file with "reset" or via GDB with "monitor reset".

Following remote commands are available:

Remote command	Explanation
<code>clrbp</code>	Removes an instruction breakpoint.
<code>cp15</code>	Reads or writes from/to cp15 register.
<code>device</code>	Select the specified target device.
<code>DisableChecks</code>	Do not check if an abort occurred after memory read (ARM7/9 only).
<code>EnableChecks</code>	Check if an abort occurred after memory read (ARM7/9 only).
<code>flash breakpoints</code>	Enables/Disables flash breakpoints.
<code>getargs</code>	Get the arguments for the application.
<code>go</code>	Starts the target CPU.
<code>halt</code>	Halts the target CPU.
<code>jtagconf</code>	Configures a JTAG scan chain with multiple devices on it.
<code>memU8</code>	Reads or writes a byte from/to given address.
<code>memU16</code>	Reads or writes a halfword from/to given address.
<code>memU32</code>	Reads or writes a word from/to given address.
<code>reg</code>	Reads or writes from/to given register.
<code>regs</code>	Reads and displays all CPU registers.
<code>reset</code>	Resets and halts the target CPU.
<code>semihosting breakOn-Error</code>	Enable or disable halting the target on semihosting error.
<code>semihosting enable</code>	Enables semihosting.
<code>semihosting IOClient</code>	Set semihosting I/O to be handled via Telnet port or GDB.
<code>semihosting ARMSWI</code>	Sets the SWI number used for semihosting in ARM mode.
<code>semihosting ThumbSWI</code>	Sets the SWI number used for semihosting in thumb mode.
<code>setargs</code>	Set the arguments for the application.
<code>setbp</code>	Sets an instruction breakpoint at a given address.
<code>sleep</code>	Sleeps for a given time period.
<code>speed</code>	Sets the JTAG speed of J-Link / J-Trace.
<code>step</code>	Performs one or more single instruction steps.
<code>SWO DisableTarget</code>	Undo target configuration for SWO and disable it in J-Link.
<code>SWO EnableTarget</code>	Configure target for SWO and enable it in J-Link.
<code>SWO GetMaxSpeed</code>	Prints the maximum supported SWO speed for J-Link and Target CPU.
<code>SWO GetSpeedInfo</code>	Prints the available SWO speed and its minimum divider.
<code>waithalt</code>	Waits for target to halt code execution.
<code>wice</code>	Writes to given IceBreaker register.

Table 3.2: GDB remote commands

Following remote commands are deprecated and only available for backward compatibility:

Remote command	Explanation
<code>device</code>	Select the specified target device. Note: Use command line option <code>-device</code> instead.
<code>interface</code>	Select the target interface. Note: Use command line option <code>-if</code> instead.
<code>speed</code>	Sets the JTAG speed of J-Link / J-Trace. Note: For the initial connection speed, use command line option <code>-speed</code> instead.

Table 3.3: GDB remote commands

Note: The remote commands are case-insensitive.

Note: Optional parameters are set into square brackets.

Note: The examples are described as follows:

Lines starting with '#' are comments and not used in GDB / GDB Server.

Lines starting with '>' are input commands from the GDB.

Lines starting with '<' is the output from GDB Server as printed in GDB.

3.3.3.1 clrbp

Syntax

```
ClrBP [<BPHandle>]
```

or

```
ci [<BPHandle>]
```

Description

Removes an instruction breakpoint, where <BPHandle> is the handle of breakpoint to be removed. If no handle is specified this command removes all pending breakpoints.

Example

```
> monitor clrbp 1
```

or

```
> monitor ci 1
```

3.3.3.2 cp15

Syntax

```
cp15 <CRn>, <CRm>, <op1>, <op2> [= <data>]
```

Description

Reads or writes from/to cp15 register. If <data> is specified, this command writes the data to the cp15 register. Otherwise this command reads from the cp15 register. For further information please refer to the ARM reference manual.

Example

```
#Read:  
> monitor cp15 1, 2, 6, 7  
< Reading CP15 register (1,2,6,7 = 0x0460B77D)
```

```
#Write:  
> monitor cp15 1, 2, 6, 7 = 0xFFFFFFFF
```

3.3.3.3 device

Note: Deprecated. Use command line option `-device` instead.

Syntax

```
device <DeviceName>
```

Description

Selects the specified target device. This is necessary for the connection and some special handling of the device.

Note: The device should be selected via commandline option `-device` when starting GDB Server.

Example

```
> monitor device STM32F417IG  
< Selecting device: STM32F417IG
```

3.3.3.4 DisableChecks

Syntax

```
DisableChecks
```

Description

Disables checking if a memory read caused an abort (ARM7/9 devices only). On some CPUs during the init sequence for enabling access to the internal memory (for example on the TMS470) some dummy reads of memory are required which will cause an abort as long as the access-init is not completed.

3.3.3.5 EnableChecks

Syntax

```
EnableChecks
```

Description

Enables checking if a memory read caused an abort (ARM7/9 devices only). On some CPUs during the init sequence for enabling access to the internal memory (for example on the TMS470) some dummy reads of memory are required which will cause an abort as long as the access-init is not completed. The default state is: Checks enabled.

3.3.3.6 flash breakpoints

Syntax

```
monitor flash breakpoints = <Value>
```

Description

This command enables/disables the Flash Breakpoints feature.

By default Flash Breakpoints are enabled and can be used for evaluation.

Example

```
#Disable Flash Breakpoints:
> monitor flash breakpoints = 0
< Flash breakpoints disabled

#Enable Flash Breakpoints:
> monitor flash breakpoints = 1
< Flash breakpoints enabled
```

3.3.3.7 getargs

Syntax

```
getargs
```

Description

Get the currently set argument list which will be given to the application when calling semihosting command SYS_GET_CMDLINE (0x15). The argument list is given as one string.

Example

```
#No arguments set via setargs:
> monitor getargs
< No arguments.
#Arguments set via setargs:
> monitor getargs
< Arguments: test 0 1 2 arg0=4
```

3.3.3.8 go

Syntax

```
go
```

Description

Starts the target CPU.

Example

```
> monitor go
```

3.3.3.9 halt**Syntax**

```
halt
```

Description

Halts the target CPU.

Example

```
> monitor halt
```

3.3.3.10 interface

Note: Deprecated. Use command line option `-if` instead.

Syntax

```
interface <InterfaceIdentifier>
```

Description

Selects the target interface used by J-Link / J-Trace.

3.3.3.11 jtagconf**Syntax**

```
jtagconf <IRPre> <DRPre>
```

Description

Configures a JTAG scan chain with multiple devices on it. `<IRPre>` is the sum of IRLens of all devices closer to TDI, where IRLen is the number of bits in the IR (Instruction Register) of one device. `<DRPre>` is the number of devices closer to TDI. For more detailed information of how to configure a scan chain with multiple devices please refer to See "Determining values for scan chain configuration" on page 143..

Note: To make sure the connection to the device can be established correctly, it is recommended to configure the JTAG scan chain via command line options at start of GDB Server.

Example

```
#Select the second device, where there is 1 device in front with IRLen 4  
> monitor jtagconf 4 1
```

3.3.3.12 memU8**Syntax**

```
MemU8 <address> [= <value>]
```

Description

Reads or writes a byte from/to a given address. If `<value>` is specified, this command writes the value to the given address. Otherwise this command reads from the given address.

Example

```
#Read:
> monitor memU8 0x50000000
< Reading from address 0x50000000 (Data = 0x04)

#Write:
> monitor memU8 0x50000000 = 0xFF
< Writing 0xFF @ address 0x50000000
```

3.3.3.13 memU16

Syntax

```
memU16 <address> [= <value>]
```

Description

Reads or writes a halfword from/to a given address. If <value> is specified, this command writes the value to the given address. Otherwise this command reads from the given address.

Example

```
#Read:
> monitor memU16 0x50000000
< Reading from address 0x50000000 (Data = 0x3004)

#Write:
> monitor memU16 0x50000000 = 0xFF00
< Writing 0xFF00 @ address 0x50000000
```

3.3.3.14 memU32

Syntax

```
MemU32 <address> [= <value>]
```

Description

Reads or writes a word from/to a given address. If <value> is specified, this command writes the value to the given address. Otherwise this command reads from the given address. This command is similar to the long command.

Example

```
#Read:
> monitor memU32 0x50000000
< Reading from address 0x50000000 (Data = 0x10023004)

#Write:
> monitor memU32 0x50000000 = 0x10023004
< Writing 0x10023004 @ address 0x50000000
```

3.3.3.15 reg

Syntax

```
reg <RegName> [= <value>]
```

or

```
reg <RegName> [= (<address>)]
```

Description

Reads or writes from/to given register. If <value> is specified, this command writes the value into the given register. If <address> is specified, this command writes the memory content at address <address> to register <RegName>. Otherwise this command reads the given register.

Example

```
#Write value to register:
> monitor reg pc    = 0x00100230
< Writing register (PC = 0x00100230)

#Write value from address to register:
> monitor reg r0    = (0x00000040)
< Writing register (R0 = 0x14813004)

#Read register value:
> monitor reg PC
< Reading register (PC = 0x00100230)
```

3.3.3.16 regs

Syntax

```
regs
```

Description

Reads all CPU registers.

Example

```
> monitor regs
< PC = 00100230, CPSR = 20000013 (SVC mode, ARM)
R0 = 14813004, R1 = 00000001, R2 = 00000001, R3 = 000003B5
R4 = 00000000, R5 = 00000000, R6 = 00000000, R7 = 00000000
USR: R8 =00000000, R9 =00000000, R10=00000000, R11 =00000000, R12 =00000000
    R13=00000000, R14=00000000
FIQ: R8 =00000000, R9 =00000000, R10=00000000, R11 =00000000, R12 =00000000
    R13=00200000, R14=00000000, SPSR=00000010
SVC: R13=002004E8, R14=0010025C, SPSR=00000010
ABT: R13=00200100, R14=00000000, SPSR=00000010
IRQ: R13=00200100, R14=00000000, SPSR=00000010
UND: R13=00200100, R14=00000000, SPSR=00000010
```

3.3.3.17 reset

Syntax

```
reset
```

Description

Resets and halts the target CPU. Make sure the device is selected prior to using this command to make use of the correct reset strategy.

Add. information

There are different reset strategies for different CPUs. Moreover, the reset strategies which are available differ from CPU core to CPU core. J-Link can perform various reset strategies and always selects the best fitting strategy for the selected device.

Example

```
> monitor reset
< Resetting target
```

3.3.3.18 semihosting breakOnError

Syntax

```
semihosting breakOnError <Value>
```

Description

Enables or disables halting the target at the semihosting breakpoint / in SVC handler if an error occurred during a semihosting command, for example a bad file handle for SYS_WRITE. The GDB Server log window always shows a warning in these cases. breakOnError is disabled by default.

Example

```
#Enable breakOnError:
> monitor semihosting breakOnError 1
```

3.3.3.19 semihosting enable

Syntax

```
semihosting enable [<VectorAddr>]
```

Description

Enables semihosting with the specified vector address. If no vector address is specified, the SWI vector (at address 0x8) will be used. GDBServer will output semihosting terminal data from the target via a separate connection on port 2333. Some IDEs already establish a connection automatically on this port and show terminal data in a specific window in the IDE.

For IDEs which do not support semihosting terminal output directly, the easiest way to view semihosting output is to open a telnet connection to the GDBServer on port 2333. The connection on this port can be opened all the time as soon as GDBServer is started, even before this remote command is executed.

Example

```
> monitor semihosting enable
< Semihosting enabled (VectorAddr = 0x08)
```

3.3.3.20 semihosting IOClient

Syntax

```
semihosting IOClient <ClientMask>
```

Description

GDB itself can handle (file) I/O operations, too. With this command it is selected wheter to print output via TELNET port (2333), GDB, or both.

<ClientMask> is

- 1 for TELNET Client (Standard port 2333) (Default)
- 2 for GDB Client
- or 3 for both (Input via GDB Client)

Example

```
#Select TELNET port as output source
> monitor semihosting ioclient 1
< Semihosting I/O set to TELNET Client

#Select GDB as output source
> monitor semihosting ioclient 2
< Semihosting I/O set to GDB Client

#Select TELNET port and GDB as output source
> monitor semihosting ioclient 3
< Semihosting I/O set to TELNET and GDB Client
```

3.3.3.21 semihosting ARMSWI

Syntax

```
semihosting ARMSWI <Value>
```

Description

Sets the SWI number used for semihosting in ARM mode. The default value for the ARMSWI is 0x123456.

Example

```
> monitor semihosting ARMSWI 0x123456
< Semihosting ARM SWI number set to 0x123456
```

3.3.3.22 semihosting ThumbSWI**Syntax**

```
semihosting ThumbSWI <Value>
```

Description

Sets the SWI number used for semihosting in thumb mode. The default value for the ThumbSWI is 0xAB

Example

```
> monitor semihosting ThumbSWI 0xAB
< Semihosting Thumb SWI number set to 0xAB
```

3.3.3.23 setargs**Syntax**

```
setargs <ArgumentString>
```

Description

Set arguments for the application, where all arguments are in one <ArgumentString> separated by whitespaces.

The argument string can be gotten by the application via semihosting command SYS_GET_CMDLINE (0x15).

Semihosting has to be enabled for getting the argumentstring ([semihosting enable](#)). "monitor setargs" can be used before enabeling semihosting.

The maximum length for <ArgumentString> is 512 characters.

Example

```
> monitor setargs test 0 1 2 arg0=4
< Arguments: test 0 1 2 arg0=4
```

3.3.3.24 setbp**Syntax**

```
setbp <Addr> [<Mask>]
```

Description

Sets an instruction breakpoint at the given address, where <Mask> can be 0x03 for ARM instruction breakpoints (Instruction width 4 Byte, mask out lower 2 bits) or 0x01 for THUMB instruction breakpoints (Instruction width 2 Byte, mask out lower bit). If no mask is given, an ARM instruction breakpoint will be set.

Example

```
#Set a breakpoint (implicit for ARM instructions)
> monitor setbp 0x00000000

#Set a breakpoint on a THUMB instruction
> monitor setbp 0x00000100 0x01
```

3.3.3.25 sleep

Syntax

```
sleep <Delay>
```

Description

Sleeps for a given time, where <Delay> is the time period in milliseconds to delay. While sleeping any communication is blocked until the command returns after the given period.

Example

```
> monitor sleep 1000
< Sleep 1000ms
```

3.3.3.26 speed

Note: Deprecated. For setting the initial connection speed, use command line option `-speed` instead.

Syntax

```
speed <kHz>|auto|adaptive
```

Description

Sets the JTAG speed of J-Link / J-Trace. Speed can be either fixed (in kHz), automatic recognition or adaptive. In general, Adaptive is recommended if the target has an RTCK signal which is connected to the corresponding RTCK pin of the device (S-cores only). For detailed information about the different modes, refer to *JTAG Speed* on page 144.

The speed has to be set after selecting the interface, to change it from its default value.

Example

```
> monitor speed auto
< Select auto target interface speed (8000 kHz)

> monitor speed 4000
< Target interface speed set to 4000 kHz

> monitor speed adaptive
< Select adaptive clocking instead of fixed JTAG speed
```

3.3.3.27 step

Syntax

```
step [<NumSteps>]
```

or

```
si [<NumSteps>]
```

Description

Performs one or more single instruction steps, where <NumSteps> is the number of instruction steps to perform. If <NumSteps> is not specified only one instruction step will be performed.

Example

```
> monitor step 3
```

3.3.3.28 SWO DisableTarget

Syntax

```
SWO DisableTarget <PortMask[0x01-0xFFFFFFFF]>
```

Description

Disables the output of SWO data on the target (Undoes changes from SWO Enable-Target) and stops J-Link to capture it.

Example

```
#Disable captureing SWO from stimulus ports 0 and 1
> monitor SWO DisableTarget 3
< SWO disabled succesfully.
```

3.3.3.29 SWO EnableTarget

Syntax

```
SWO EnableTarget <CPUFreq[Hz]> <SWOFreq[Hz]> <PortMask[0x01-0xFFFFFFFF]
<Mode[0]>
```

Description

Configures the target to be able to output SWO data and starts J-Link to capture it. CPU and SWO frequency can be 0 for auto-detection.

If CPUFreq is 0, J-Link will measure the current CPU speed.

If SWOFreq is 0, J-Link will use the highest available SWO speed for the selected / measured CPU speed.

Note: CPUFreq has to be the speed at which the target will be running when doing SWO.

If the speed is different from the current speed when issuing CPU speed auto-detection, getting SWO data might fail.

SWOFreq has to be a quotient of the CPU and SWO speeds and their prescalers. To get available speed, use SWO GetSpeedInfo.

PortMask can be a decimal or hexadecimal Value. Values starting with the Prefix "0x" are handled hexadecimal.

Example

```
#Configure SWO for stimulus port 0, measure CPU frequency and calculate SWO frequency
> monitor SWO EnableTarget 0 0 1 0
< SWO enabled succesfully.
```

```
#Configure SWO for stimulus ports 0-2, fixed SWO frequency and measure CPU frequency
> monitor SWO EnableTarget 0 1200000 5 0
< SWO enabled succesfully.
```

```
#Configure SWO for stimulus ports 0-255, fixed CPU and SWO frequency
> monitor SWO EnableTarget 72000000 6000000 0xFF 0
< SWO enabled succesfully.
```

3.3.3.30 SWO GetMaxSpeed

Syntax

```
SWO GetMaxSpeed <CPUFrequency [Hz]>
```

Description

Prints the maximum SWO speed supported by and matching both, J-Link and the target CPU frequency.

Example

```
#Get SWO speed for 72MHz CPU speed
> monitor SWO GetMaxSpeed 72000000
< Maximum supported SWO speed is 6000000 Hz.
```

3.3.3.31 SWO GetSpeedInfo

Syntax

```
SWO GetSpeedInfo
```

Description

Prints the base frequency and the minimum divider of the connected J-Link. With this, the available SWO speeds for J-Link can be calculated and the matching one for the target CPU frequency can be selected.

Example

```
> monitor SWO GetSpeedInfo
< Base frequency: 60000000Hz, MinDiv: 8
# Available SWO speeds for J-Link are: 7.5MHz, 6.66MHz, 6MHz, ...
```

3.3.3.32 waithalt

Syntax

```
waithalt <Timeout>
```

or

```
wh <Timeout>
```

Description

Waits for target to halt code execution, where <Timeout> is the maximum time period in milliseconds to wait.

Example

```
#Wait for halt with a timeout of 2 seconds
> monitor waithalt 2000
```

3.3.3.33 wice

Syntax

```
wice <RegIndex> <value>
```

or

```
rmib <RegIndex> <value>
```

Description

Writes to given IceBreaker register, where <value> is the data to write.

Example

```
> monitor wice 0x0C 0x100
```

3.3.4 SEGGER-specific GDB protocol extensions

J-Link GDB Server implements some functionality which are not part of the standard GDB remote protocol in general query packets. These SEGGER-specific general query packets can be sent to GDB Server on the low-level of GDB, via maintenance commands, or with a custom client connected to GDB Server.

General query packets start with a 'q'. SEGGER-specific general queries are followed by the identifier 'Segger' plus the command group, the actual command and its parameters.

Following SEGGER-specific general query packets are available:

Query Packet	Explanation
qSeggerSTRACE:config	Configure STRACE for usage.
qSeggerSTRACE:start	Start STRACE.
qSeggerSTRACE:stop	Stop STRACE.
qSeggerSTRACE:read	Read STRACE data.

Table 3.4: General Queries

3.3.4.1 qSeggerSTRACE:config

Syntax

qSeggerSTRACE:config:<ConfigString>

Parameter

ConfigString: String containing the configuration data separating settings by ';'.

Description

Configures STRACE for usage. Configuration for example includes specification of the trace port width to be used for tracing (1-bit, 2-bit, 4-bit (default) Port-Width=%Var%).

Note: For more information please refer to *UM08002* (J-Link SDK user guide), chapter *STRACE*.

Response

<ReturnValue>

ReturnValue is a 4 Byte signed integer.

>= 0 O.K.
< 0 Error.

Note: ReturnValue is hex-encoded.
Return value 0 is "00000000", return value -1 is "FFFFFFFF".

3.3.4.2 qSeggerSTRACE:start

Syntax

qSeggerSTRACE:start

Description

Starts capturing of STRACE data.

Note: For more information please refer to *UM08002* (J-Link SDK user guide), chapter *STRACE*.

Response

<ReturnValue>

ReturnValue is a 4 Byte signed integer.

>= 0 O.K.
< 0 Error.

Note: ReturnValue is hex-encoded.
Return value 0 is "00000000", return value -1 is "FFFFFFFF".

3.3.4.3 qSeggerSTRACE:stop

Syntax

qSeggerSTRACE:stop

Description

Stops capturing of STRACE data.

Note: For more information please refer to *UM08002* (J-Link SDK user guide), chapter *STRACE*.

Response

<ReturnValue>

ReturnValue is a 4 Byte signed integer.

>= 0 O.K.
< 0 Error.

Note: ReturnValue is hex-encoded.
Return value 0 is "00000000", return value -1 is "FFFFFFFF".

3.3.4.4 qSeggerSTRACE:read

Syntax

qSeggerSTRACE:read:<NumItems>

Parameter

NumItems: Maximum number of trace data (addresses) to be read. Hexadecimal.

Description

Read the last recently called instruction addresses. The addresses are returned LIFO, meaning the last recent address is returned first.

Note: For more information please refer to *UM08002* (J-Link SDK user guide), chapter *STRACE*.

Response

<ReturnValue> [<Item0><Item1>...]

ReturnValue is a 4 Byte signed integer.

>= 0 Number of items read.
< 0 Error.

ItemN is a 4 Byte unsigned integer.

0x00000000 - 0xFFFFFFFF Address of the executed instruction

Note: ReturnValue and ItemN are hex-encoded.
e.g. 3 Items read: 0x08000010, 0x08000014, 0x08000018
Response will be: 00000003080000100800001408000018

3.3.5 Command line options

There are several command line options available for the GDB Server which allow configuration of the GDB Server before any connection to a J-Link is attempted or any connection from a GDB client is accepted.

Note: Using GDB Server CL, device, interface, endian and speed are mandatory options to correctly connect to the target, and should be given before connection via GDB. Using GDB Server GUI the mandatory options can also be selected in the configuration dialog.

Command line option	Explanation
<code>-device</code>	Select the connected target device.
<code>-endian</code>	Select the device endianness.
<code>-if</code>	Select the interface to connect to the target.
<code>-speed</code>	Select the target communication speed.

Table 3.5: Mandatory command line options

Note: Using multiple instances of GDB Server, setting custom values for port, SWOPort and TelnetPort is necessary.

Command line option	Explanation
<code>-port</code>	Select the port to listen for GDB clients.
<code>-swoport</code>	Select the port to listen for clients for SWO RAW output.
<code>-telnetport</code>	Select the port to listen for clients for printf output.

Table 3.6: Port selection command line options

The GDB Server GUI version uses persistent settings which are saved across different instances and sessions of GDB Server. These settings can be toggled via the checkboxes in the GUI.

Note: GDB Server CL always starts with the settings marked as default.

For GUI and CL, the settings can be changed with following command line options. For all persistent settings there is a pair of options to enable or disable the feature.

Command line option	Explanation
<code>-ir</code> <code>-noir</code>	Initialize the CPU registers on start of GDB Server. (Default) Do not initialize CPU registers on start of GDB Server.
<code>-localhostonly</code> <code>-nolocalhostonly</code>	Allow only localhost connections (Windows default) Allow connections from outside localhost (Linux default)
<code>-logtofile</code> <code>-nologtofile</code>	Generate a GDB Server log file. Do not generate a GDB Server log file. (Default)
<code>-halt</code> <code>-nohalt</code>	Halt the target on start of GDB Server. Do not halt the target on start of GDB Server. (Default)
<code>-silent</code> <code>-nosilent</code>	Do not show log output. Show log output. (Default)
<code>-stayontop</code> <code>-nostayontop</code>	Set the GDB Server GUI to be the topmost window. Do not be the topmost window. (Default)
<code>-vd</code> <code>-novd</code>	Verify after downloading. Do not verify after downloading. (Default)

Table 3.7: Persistent command line options

Following additional command line options are available. These options are temporary for each start of GDB Server.

Command line option	Explanation
<code>-jtagconf</code>	Configures a JTAG scan chain with multiple devices on it.
<code>-log</code>	Log the GDB Server communication to a specific file.
<code>-notimeout</code>	Do not close GDB Server when target connection fails.
<code>-singlerun</code>	Start GDB Server in single run mode.
<code>-scriptfile</code>	Use a J-Link scriptfile.
<code>-select</code>	Select the interface to connect to J-Link (USB/IP).
<code>-settingsfile</code>	Select the J-Link Settings File.
<code>-x</code>	Execute a gdb file on first connection.
<code>-xc</code>	Execute a gdb file on every connection.
<code>-cpu</code>	Select the CPU core. Deprecated, use <code>-device</code> instead.

Table 3.8: General command line options

3.3.5.1 -cpu

Description

Pre-select the CPU core of the connected device, so the GDB Server already knows the register set, even before having established a connection to the CPU.

Note: Deprecated, please use `-device` instead. Anyhow, does not hurt if this option is set, too.

Syntax

```
-CPU <CPUCore>
```

Example

```
jlinkgdbserver -CPU ARM7_9
```

Add. information

The following table lists all valid values for <CPUCore>:

<CPUCore>	Supported CPU cores
CPU_FAMILY_ARM7_9	Pre-select ARM7 and ARM9 as CPU cores.
CPU_FAMILY_CORTEX_A_R	Pre-select Cortex-A and Cortex-R as CPU cores.
CPU_FAMILY_CORTEX_M	Pre-select Cortex-M as CPU core.
CPU_FAMILY_RX600	Pre-select Renesas RX600 as CPU core.

Table 3.9: GDB allowed values for CPUCore

3.3.5.2 -device

Description

Tells GDBServer to which device J-Link is connected before the connect sequence is actually performed. It is recommended to use the command line option to select the device instead of using the remote command since for some devices J-Link already needs to know the device at the time of connecting to it since some devices need special connect sequences (e.g. devices with TI ICEPick modules). In such cases, it is not possible to select the device via remote commands since they are configured after the GDB client already connected to GDBServer and requested the target registers which already requires a connection to the target.

Note: Using GDB Server CL this option is mandatory to correctly connect to the target, and should be given before connection via GDB.

Syntax

```
-device <DeviceName>
```

Example

```
jlinkgdbserver -device AT91SAM7SE256
```

Add. information

For a list of all valid values for <DeviceName>, please refer to http://www.segger.com/jlink_supported_devices.html.

3.3.5.3 -endian

Description

Sets the endianness of the target where endianness can either be "little" or "big".

Note: Using GDB Server CL this option is mandatory to correctly connect to the target, and should be given before connection via GDB.

Syntax

```
-endian <endianess>
```

Example

```
jlinkgdbserver -endian little
```

3.3.5.4 -if

Description

Selects the target interface which is used by J-Link to connect to the device. The default value is JTAG.

Note: Using GDB Server CL this option is mandatory to correctly connect to the target, and should be given before connection via GDB.

Syntax

```
-if <Interface>
```

Example

```
jlinkgdbserver -if SWD
```

Add. information

Currently, the following values are accepted for <Interface>:

- JTAG
- SWD
- FINE
- 2-wire-JTAG-PIC32

3.3.5.5 -ir

Description

Initializes the CPU register with default values on startup.

Note: For the GUI version, this setting is persistent for following uses of GDB Server until changed via -noir or the GUI.

Example

```
jlinkgdbserver -ir
```

3.3.5.6 -jtagconf

Syntax

```
-jtagconf <IRPre>,<DRPre>
```

Description

Configures a JTAG scan chain with multiple devices on it. <IRPre> is the sum of IRLens of all devices closer to TDI, where IRLen is the number of bits in the IR (Instruction Register) of one device. <DRPre> is the number of devices closer to TDI. For more detailed information of how to configure a scan chain with multiple devices please refer to See "Determining values for scan chain configuration" on page 143..

Example

```
#Select the second device, where there is 1 device in front with IRLen 4  
jlinkgdbserver -jtagconf 4,1
```

3.3.5.7 -localhostonly

Description

Starts the GDB Server with the option to listen on localhost only (This means that only TCP/IP connections from localhost are accepted) or on any IP address. To allow remote debugging (connecting to GDBServer from another PC), deactivate this option.

If no parameter is given, it will be set to 1 (active).

Note: For the GUI version, this setting is persistent for following uses of GDB Server until changed via command line option or the GUI.

Syntax

```
-LocalhostOnly <State>
```

Example

```
jlinkgdbserver -LocalhostOnly 0 //Listen on any IP address (Linux/MAC default)
```

```
jlinkgdbserver -LocalhostOnly 1 //Listen on localhost only (Windows default)
```

3.3.5.8 -log

Description

Starts the GDB Server with the option to write the output into a given log file. The file will be created if it does not exist. If it exists the previous content will be removed. Paths including spaces need to be set between quotes.

Syntax

```
-log <LogFilePath>
```

Example

```
jlinkgdbserver -log "C:\my path\to\file.log"
```

3.3.5.9 -logtofile

Description

Starts the GDB Server with the option to write the output into a log file.

If no file is given via `-log`, the log file will be created in the GDB Server application directory.

Note: For the GUI version, this setting is persistent for following uses of GDB Server until changed via `-nologtofile` or the GUI.

Syntax

```
-logtofile
```

Example

```
jlinkgdbserver -logtofile
```

```
jlinkgdbserver -logtofile -log "C:\my path\to\file.log"
```

3.3.5.10 -halt

Description

Halts the target after connecting to it on start of GDB Server.

For most IDEs this option is mandatory since they rely on the target to be halted after connecting to GDB Server.

Note: For the GUI version, this setting is persistent for following uses of GDB Server until changed via `-nohalt` or the GUI.

Syntax

```
-halt
```

Example

```
jlinkgdbserver -halt
```

3.3.5.11 -noir

Description

Do not initialize the CPU registers on startup.

Note: For the GUI version, this setting is persistent for following uses of GDB Server until changed via `-ir` or the GUI.

Syntax

```
-noir
```

3.3.5.12 -nolocalhostonly

Description

Starts GDB Server with the option to allow remote connections (from outside local-host).

Same as `-localhostonly 0`

Note: For the GUI version, this setting is persistent for following uses of GDB Server until changed via command line option or the GUI.

Syntax

```
-nolocalhostonly
```

3.3.5.13 -nologtofile

Description

Starts the GDB Server with the option to not write the output into a log file.

Note: For the GUI version, this setting is persistent for following uses of GDB Server until changed via `-nologtofile` or the GUI.

Note: When this option is used after `-log`, no log file will be generated, when `-log` is used after this option, a log file will be generated and this setting will be overridden.

Syntax

```
-nologtofile
```

Example

```
jlinkgdbserver -nologtofile // Will not generate a log file
jlinkgdbserver -nologtofile -log "C:\pathto\file.log" // Will generate a log file
jlinkgdbserver -log "C:\pathto\file.log" -nologtofile // Will not generate a log file
```

3.3.5.14 -nohalt

Description

When connecting to the target after starting GDB Server, the target is not explicitly halted and the CPU registers will not be initied.

After closing all GDB connections the target is started again and continues running.

Some IDEs rely on the target to be halted after connect. In this case do not use -nohalt, but -halt.

Note: For the GUI version, this setting is persistent for following uses of GDB Server until changed via -halt or the GUI.

Syntax

```
-nohalt
```

Example

```
jlinkgdbserver -nohalt
```

3.3.5.15 -nosilent

Description

Starts the GDB Server in non-silent mode. All log window messages will be shown.

Note: For the GUI version, this setting is persistent for following uses of GDB Server until changed via command line option or the GUI.

Syntax

```
-nosilent
```

3.3.5.16 -nostayontop

Description

Starts the GDB Server in non-topmost mode. All windows can be placed above it.

Note: For the CL version this setting has no effect.

Note: For the GUI version, this setting is persistent for following uses of GDB Server until changed via command line option or the GUI.

Syntax

```
-nostayontop
```

3.3.5.17 -notimeout

Description

GDB Server automatically closes after a timeout of 5 seconds when no target voltage can be measured or connection to target fails.

This command line option prevents GDB Server from closing, to allow connecting a target after starting GDB Server.

Note: The recommended order is to power the target, connect it to J-Link and then start GDB Server.

Syntax

```
-notimeout
```

3.3.5.18 -novd

Description

Do not explicitly verify downloaded data.

Note: For the GUI version, this setting is persistent for following uses of GDB Server until changed via command line option or the GUI.

Syntax

```
-vd
```

3.3.5.19 -port

Description

Starts GDB Server listening on a specified port. This option overrides the default listening port of the GDB Server. The default port is 2331.

Note: Using multiple instances of GDB Server, setting custom values for this option is necessary.

Syntax

```
-port <Port>
```

Example

```
jlinkgdbserver -port 2345
```

3.3.5.20 -scriptfile

Description

Passes the path of a J-Link script file to the GDB Server. This scriptfile is executed before the GDB Server starts the debugging / identifying communication with the target. J-Link scriptfiles are mainly used to connect to targets which need a special connection sequence before communication with the core is possible. For more information about J-Link script files, please refer to *J-Link script files* on page 165.

Syntax

```
-scriptfile <ScriptFilePath>
```

Example

```
-scriptfile "C:\My Projects\Default.JLinkScript"
```

3.3.5.21 -select

Description

Specifies the host interface to be used to connect to J-Link. Currently, USB and TCP/IP are available.

Syntax

```
-select <Interface>=<SerialNo>/<IPAddr>
```

Example

```
jlinkgdbserver -select usb=580011111  
jlinkgdbserver -select ip=192.168.1.10
```

Additional information

For backward compatibility, when USB is used as interface serial numbers from 0-3 are accepted as USB=0-3 to support the old method of connecting multiple J-Links to a PC. This method is no longer recommended to be used. Please use the "connect via emulator serial number" method instead.

3.3.5.22 -settingsfile

Description

Select a J-Link settings file to be used for the target device. The settings fail can contain all configurable options of the Settings tab in J-Link Control panel.

Syntax

```
-SettingsFile <PathToFile>
```

Example

```
jlinkgdbserver -SettingsFile "C:\Temp\GDB Server.jlink"
```

3.3.5.23 -silent

Description

Starts the GDB Server in silent mode. No log window messages will be shown.

Note: For the GUI version, this setting is persistent for following uses of GDB Server until changed via command line option or the GUI.

Syntax

```
-silent
```

3.3.5.24 -singlerun

Description

Starts GDB Server in single run mode. When active, GDB Server will close when all client connections are closed.

In normal run mode GDB Server will stay open and wait for new connections.

When started in single run mode GDB Server will close immediately when connecting to the target fails. Make sure it is powered and connected to J-Link before starting GDB Server.

Syntax

```
-s  
-singlerun
```

3.3.5.25 -speed

Description

Starts GDB Server with a given initial speed.

Available parameters are "adaptive", "auto" or a freely selectable integer value in kHz. It is recommended to use either a fixed speed or, if it is available on the target, adaptive speeds.

Note: Using GDB Server CL this option is mandatory to correctly connect to the target, and should be given before connection via GDB.

Syntax

```
-speed <Speed_kHz>
```

Example

```
jlinkgdbserver -speed 2000
```

3.3.5.26 -stayontop

Description

Starts the GDB Server in topmost mode. It will be placed above all non-topmost windows and maintains its position even when it is deactivated.

Note: For the CL version this setting has no effect.

Note: For the GUI version, this setting is persistent for following uses of GDB Server until changed via command line option or the GUI.

Syntax

```
-stayontop
```

3.3.5.27 -swoport

Description

Set up port on which GDB Server should listen for an incoming connection that reads the SWO data from GDB Server. Default port is 2332.

Note: Using multiple instances of GDB Server, setting custom values for this option is necessary.

Syntax

```
-SWOPort <Port>
```

Example

```
jlinkgdbserver -SWOPort 2553
```

3.3.5.28 -telnetport

Description

Set up port on which GDB Server should listen for an incoming connection that gets target's printf data (Semihosting and analyzed SWO data). Default port is 2333.

Note: Using multiple instances of GDB Server, setting custom values for this option is necessary.

Syntax

```
-TelnetPort <Port>
```

Example

```
jlinkgdbserver -TelnetPort 2554
```

3.3.5.29 -vd

Description

Verifies the data after downloading it.

Note: For the GUI version, this setting is persistent for following uses of GDB Server until changed via command line option or the GUI.

Syntax

```
-vd
```

3.3.5.30 -x

Description

Starts the GDB Server with a gdbinit (configuration) file. In contrast to the `-xc` command line option the GDB Server runs the commands in the gdbinit file once only direct after the first connection of a client.

Syntax

```
-x <ConfigurationFilePath>
```

Example

```
jlinkgdbserver -x C:\MyProject\Sample.gdb
```

3.3.5.31 -xc

Description

Starts the GDB Server with a gdbinit (configuration) file. GDB Server executes the commands specified in the gdbinit file with every connection of a client / start of a debugging session.

Syntax

```
-xc <ConfigurationFilePath>
```

Example

```
jlinkgdbserver -xc C:\MyProject\Sample.gdb
```

3.4 J-Link Remote Server

J-Link Remote Server allows using J-Link / J-Trace remotely via TCP/IP. This enables you to connect to and fully use a J-Link / J-Trace from another computer. Performance is just slightly (about 10%) lower than with direct USB connection.

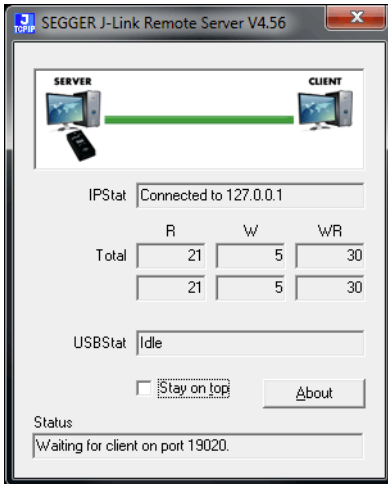

The J-Link Remote Server also accepts commands which are passed to the J-Link Remote Server via the command line.

3.4.1 List of available commands

The table below lists the commands accepted by the J-Link Remote Server

Command	Description
<code>port</code>	Selects the IP port on which the J-Link Remote Server is listening.
<code>usb</code>	Selects a usb port for communication with J-Link.

Table 3.10: Available commands

3.4.1.1 port

Syntax

```
-port <Portno.>
```

Example

To start the J-Link Remote Server listening on port 19021 the command should look as follows:

```
-port 19021
```

3.4.1.2 usb

Syntax

```
-usb <USBIndex>
```

Example

Currently usb 0-3 are supported, so if the J-Link Remote Server should connect to the J-Link on usb port 2 the command should look as follows:

```
-usb 2
```

3.4.2 Tunneling mode

The Remote server provides a tunneling mode which allows remote connection to a J-Link / J-Trace from any computer, even from outside the local network.

To give access to a J-Link neither a remote desktop or vpn connection nor changing some difficult firewall settings are necessary.

When started in tunneling mode the Remote server connects to the SEGGER tunnel server via port 19020 and registers with its serial number. To connect to the J-Link from the remote computer an also simple connection to tunnel:<SerialNo> can be established and the debugger is connected to the J-Link.

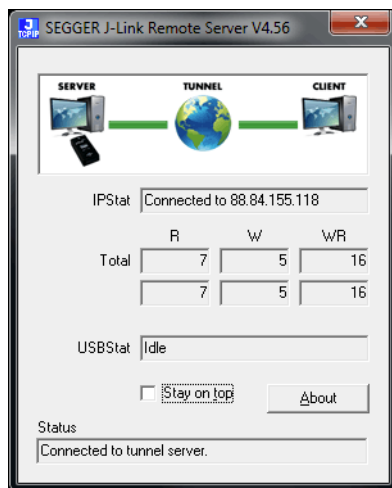
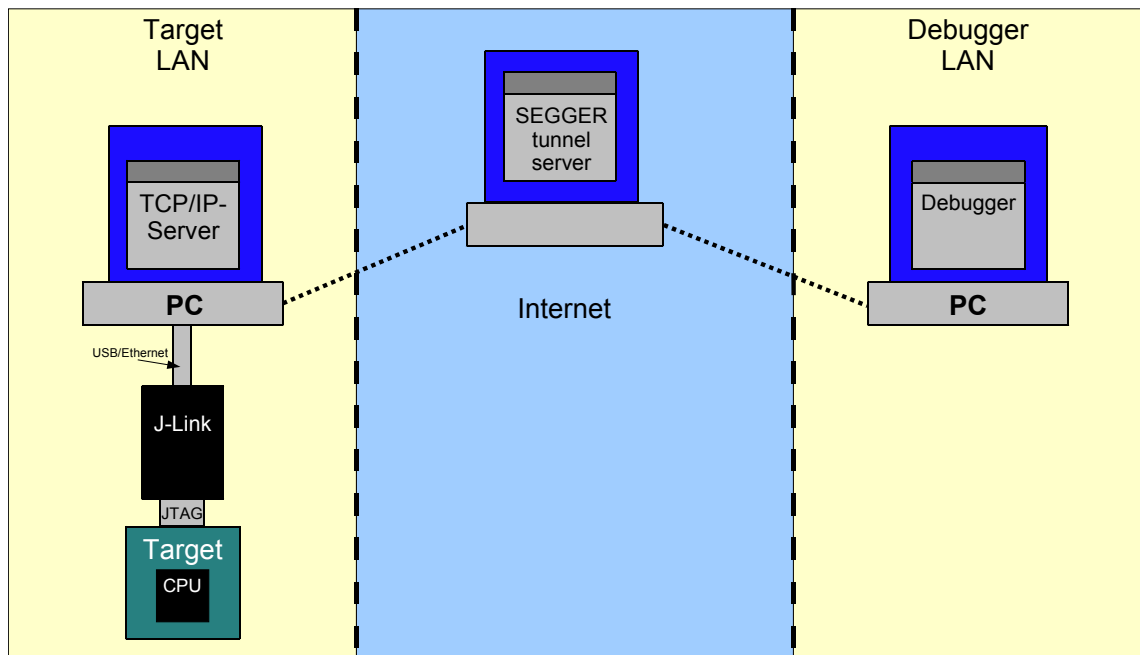

Example scenario

A device vendor is developing a new device which shall be supported by J-Link. Because there is only one prototype, a shipment to SEGGER is not possible.

Instead the vendor can connect the device via J-Link to a local computer and start the Remote server in tunneling mode. He then gives the serial number of the J-Link to an engineer at SEGGER.

The engineer at SEGGER can use J-Link Commander or a debugger to test and debug the new device without the need to have the device on his desk.

Start J-Link Remote Server in tunneling mode

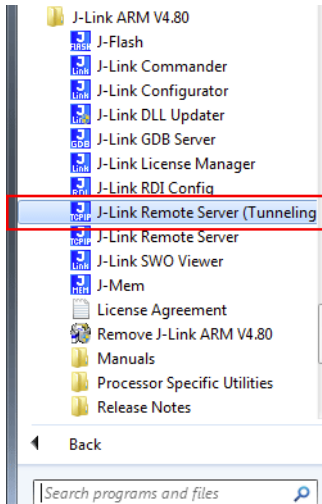

Connect to the J-Link / J-Trace via J-Link commander

J-Link Commander can be used to verify a connection to the J-Link can be established as follows:

Start J-Link Commander

From within J-Link Commander enter

```
ip tunnel:<SerialNo>
```

If the connection was successful it should look like in this screenshot.

A screenshot of the J-Link Commander terminal window. The window title is 'J-Link ARM V4.54'. The text in the terminal shows the following sequence of events: 'SEGGER J-Link Commander V4.54 ('?' for help)', 'Compiled Sep 11 2012 18:33:18', 'Can not connect to J-Link via USB.', 'J-Link>ip tunnel:59000000', 'Connecting to tunnel:59000000' (highlighted with a red box), 'DLL version V4.54, compiled Sep 11 2012 18:32:59', 'Firmware: J-Link V9 compiled Oct 2 2012 09:11:43', 'Hardware: V9.00', 'S/N: 59000000', 'VTarget = 3.312V', 'Info: TotalIRLen = 9, IRPrint = 0x0011', 'Info: Found Cortex-M4 r0p1, Little endian.', 'Info: TPIU fitted.', 'Info: ETM fitted.', 'Info: FPUnit: 6 code <BP> slots and 2 literal slots', 'Found 2 JTAG devices, Total IRLen = 9:', '#0 Id: 0x4BA00477, IRLen: 04, IRPrint: 0x1, CoreSight JTAG-DP <ARM>', '#1 Id: 0x06413041, IRLen: 05, IRPrint: 0x1, STM32 Boundary Scan', 'Cortex-M4 identified.', 'JTAG speed: 100 kHz', 'J-Link>'. The terminal window has standard Windows window controls (minimize, maximize, close) in the top right corner.

Troubleshooting

Problem	Solution
Remote server cannot connect to tunnel server	<ol style="list-style-type: none"> 1. Make sure the Remote server is not blocked by any firewall. 2. Make sure port 19020 is not blocked by any firewall. 3. Contact network admin.
J-Link Commander cannot connect to tunnel server	<ol style="list-style-type: none"> 1. Make sure Remote server is started correctly. 2. Make sure the entered serial number is correct. 3. Make sure port 19020 is not blocked by any firewall. Contact network admin.

Table 3.11:

To test whether a connection to the tunnel server can be established or not a network protocol analyzer like Wireshark can help.

The network transfer of a successful connection should look like:

Source	Destination	Protocol	Info
192.168.11.31	88.84.155.118	TCP	51439 > j-link [SYN] Seq=0 win=8192
88.84.155.118	192.168.11.31	TCP	j-link > 51439 [SYN, ACK] Seq=0 Ack=51439
192.168.11.31	88.84.155.118	TCP	51439 > j-link [ACK] Seq=1 Ack=1
192.168.11.31	88.84.155.118	TCP	51439 > j-link [PSH, ACK] Seq=5 Ack=1
192.168.11.31	88.84.155.118	TCP	51439 > j-link [PSH, ACK] Seq=5 Ack=1
88.84.155.118	192.168.11.31	TCP	j-link > 51439 [ACK] Seq=1 Ack=5
88.84.155.118	192.168.11.31	TCP	j-link > 51439 [ACK] Seq=1 Ack=9
88.84.155.118	192.168.11.31	TCP	j-link > 51439 [PSH, ACK] Seq=1 Ack=9
192.168.11.31	88.84.155.118	TCP	51439 > j-link [PSH, ACK] Seq=9 Ack=1
192.168.11.31	88.84.155.118	TCP	51439 > j-link [PSH, ACK] Seq=13 Ack=1
88.84.155.118	192.168.11.31	TCP	j-link > 51439 [ACK] Seq=5 Ack=80

3.5 J-Mem Memory Viewer

J-Mem displays memory contents of target systems and allows modifications of RAM and SFRs (Special Function Registers) while the target is running. This makes it possible to look into the memory of a target system at run-time; RAM can be modified and SFRs can be written. You can choose between 8/16/32-bit size for read and write accesses. J-Mem works nicely when modifying SFRs, especially because it writes the SFR only after the complete value has been entered.

The screenshot shows the J-Mem Memory Viewer window. At the top, there is a menu bar with 'File', 'Target', 'Options', and 'Help'. Below the menu bar is an 'Address' field containing '0x0' and buttons for 'x1', 'x2', 'x4', and 'Refresh'. The main area is a table with columns for 'Address' and 16 hex digits (0-F), followed by an 'ASCII' column. The data in the table is as follows:

Address	0	1	2	3	4	5	6	7	8	9	A	B	C	D	E	F	ASCII
00000000	06	00	00	EA	FE	FF	FF	EA	FE	FF	FF	EA	FE	FF	FF	EA
00000010	FE	FF	FF	EA	FE	FF	FF	EA	5C	07	00	EA	7C	07	00	EA\
00000020	50	D0	9F	E5	50	00	9F	E5	0F	E0	A0	E1	10	FF	2F	E1	P...P
00000030	40	00	9F	E5	D1	F0	21	E3	40	80	9F	E5	D2	F0	21	E3	e...?e
00000040	00	D0	A0	E1	60	00	40	E2	13	F0	21	E3	00	D0	A0	E1	...e
00000050	2C	00	9F	E5	0F	E0	A0	E1	10	FF	2F	E1	24	E0	9F	E5	.../\$
00000060	24	00	9F	E5	10	FF	2F	E1	FE	FF	FF	EA	FE	FF	FF	EA	\$/
00000070	FE	FF	FF	EA	FE	FF	FF	EA	00	00	21	00	91	00	00	00	...!
00000080	00	F0	FF	FF	25	01	00	00	68	00	00	00	DD	12	00	00	...%h
00000090	00	B5	1A	48	9F	21	C9	43	19	4A	0A	60	19	49	80	22	...H.C.J.I
000000A0	12	02	0A	60	18	49	01	62	81	6E	C9	07	FC	D5	17	49	...I.b.n.I
000000B0	C1	62	81	6E	49	07	FC	D5	81	6E	09	07	FC	D5	04	21	...b.nI.n!
000000C0	01	63	81	6E	09	07	FC	D5	01	6B	03	22	0A	43	02	63	...c.n.k.C.c
000000D0	81	6E	09	07	FC	D5	0E	48	0E	49	01	60	01	20	05	E0	...n.H.I.
000000E0	04	21	41	43	0A	4A	0C	4B	53	50	40	1C	1F	28	F7	DB	!AC.J.KSP.<
000000F0	0A	48	0B	49	01	60	01	BC	00	47	C0	46	00	FC	FF	FF	.H.I.G.F...
00000100	00	01	30	00	44	FD	FF	FF	01	06	00	00	05	1C	19	10	..0.D
00000110	80	F0	FF	FF	6C	00	00	00	70	00	00	00	34	F1	FF	FF	...l.p.4...
00000120	74	00	00	00	12	4A	13	48	70	B4	81	B0	11	1C	12	1D	t...J.Hp...
00000130	0A	E0	0B	68	54	68	15	68	00	2B	03	D0	5B	1E	E6	5C	...hTh.h+.I.\
00000140	EE	54	FB	D1	0C	31	0C	32	81	42	0C	D2	53	68	14	68	.T...i.2.B..Sh.h

At the bottom of the window, there is a status bar showing 'Ready', 'Connected', 'ARM core id: 3F0F0F0F', and 'Speed: 4000 kHz'.

3.6 J-Flash

J-Flash is an application to program data images to the flash of a target device. With J-Flash the internal flash of all J-Link supported devices can be programmed, as well as common external flashes connected to the device. Beside flash programming all other flash operations like erase, blank check and flash content verification can be done.

J-Flash requires an additional license from SEGGER to enable programming. For license keys, as well as evaluation licenses got to <http://www.segger.com> or contact us directly.

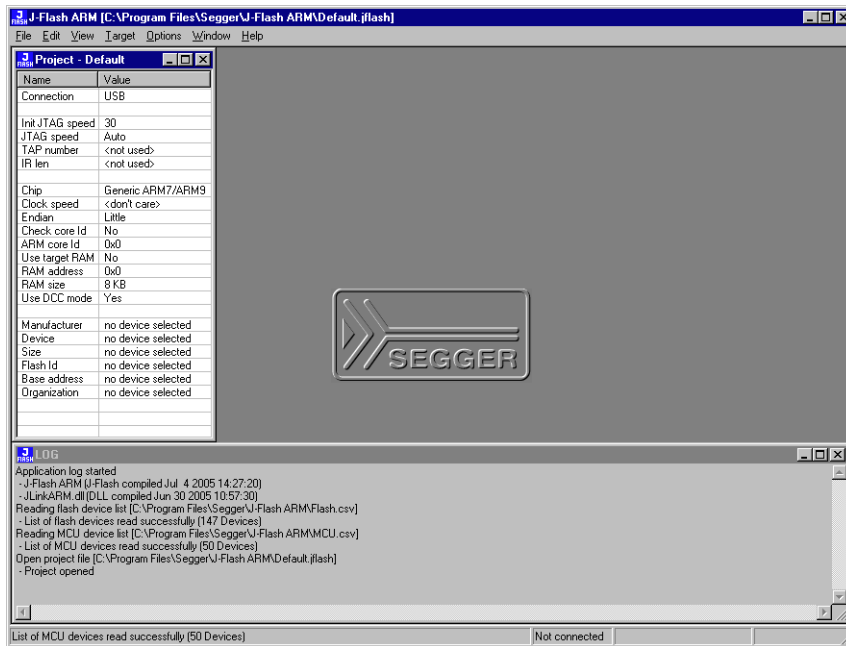

3.7 J-Link SWO Viewer

Free-of-charge utility for J-Link. Displays the terminal output of the target using the SWO pin. The stimulus port(s) from which SWO data is received can be chosen by using the port checkboxes 0 to 31. Can be used in parallel with a debugger or stand-alone. This is especially useful when using debuggers which do not come with built-in support for SWO such as most GDB / GDB+Eclipse based debug environments.

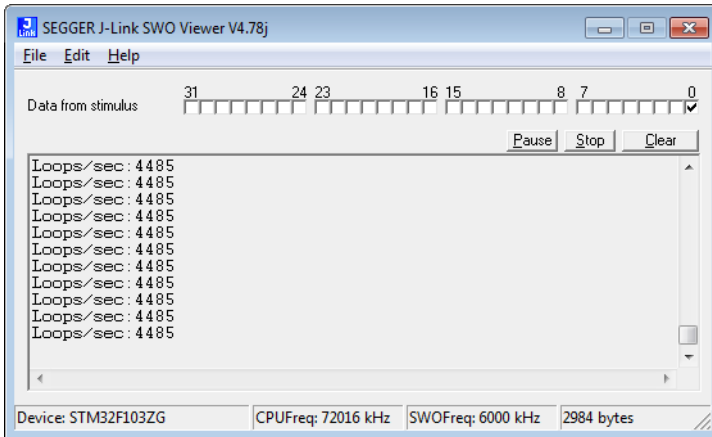

3.7.0.1 J-Link SWO Viewer CL

Commandline-only version of SWO Viewer. All commands available for J-Link SWO Viewer can be used with J-Link SWO Viewer CL. Similar to the GUI Version, J-Link SWO Viewer CL asks for a device name or CPU clock speed at startup to be able to calculate the correct SWO speed or to connect to a running J-Link GDB Server

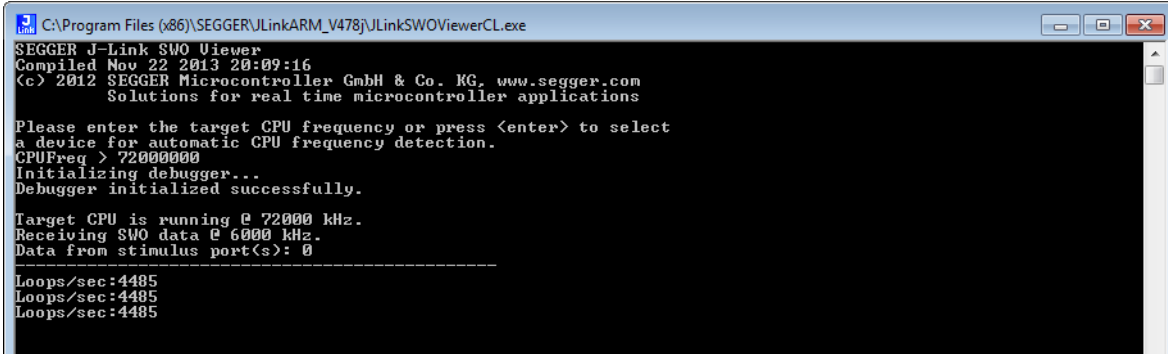

Using the syntax given below ([List of available command line options](#)), you can directly start J-Link SWO Viewer CL with parameters.

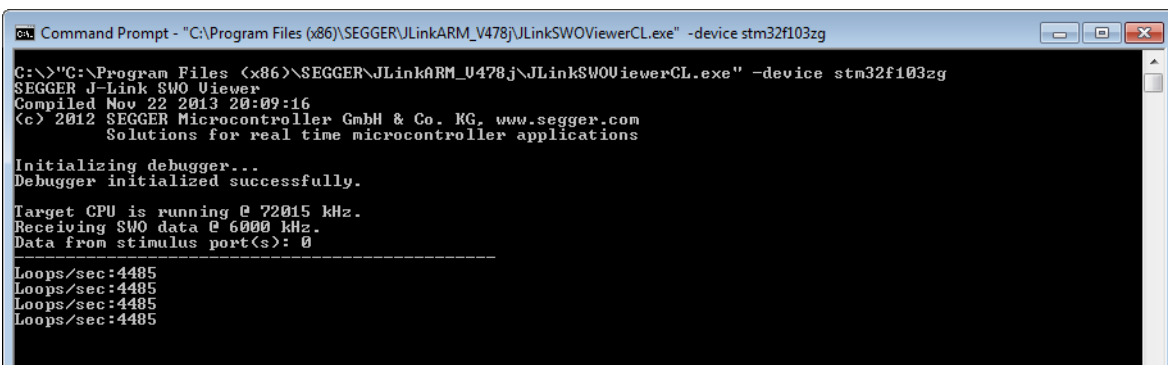

3.7.1 Usage

J-Link SWO Viewer is available via the start menu.

It asks for a device name or CPU clock speed at startup to be able to calculate the correct SWO speed or to connect to a running J-Link GDB Server.

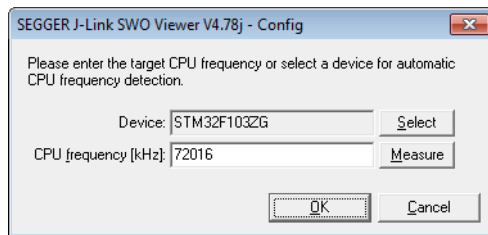

When running in normal mode J-Link SWO Viewer automatically performs the necessary initialization to enable SWO output on the target, in GDB Server mode the initialization has to be done by the debugger.

3.7.2 List of available command line options

J-Link SWO Viewer can also be controlled from the command line if used in a automated test environment etc.

When passing all necessary information to the utility via command line, the configuration dialog at startup is suppressed. Minimum information needed by J-Link SWO Viewer is the device name (to enable CPU frequency auto detection) or the CPU clock speed.

The table below lists the commands accepted by the J-Link SWO Viewer.

Command	Description
<code>cpufreq</code>	Select the CPU frequency.
<code>device</code>	Select the target device.
<code>itmmask</code>	Selects a set of itm stimulus ports which should be used to listen to.
<code>itmport</code>	Selects a itm stimulus port which should be used to listen to.
<code>outputfile</code>	Print the output of SWO Viewer to the selected file.
<code>settingsfile</code>	Specify a J-Link settings file.
<code>swofreq</code>	Select the CPU frequency.

Table 3.12: Available command line options

3.7.2.1 cpufreq

Defines the speed in Hz the CPU is running at. If the CPU is for example running at 96 MHz, the command line should look as below.

Syntax

```
-cpufreq <CPUFreq>
```

Example

```
-cpufreq 96000000
```

3.7.2.2 device

Select the target device to enable the CPU frequency auto detection of the J-Link DLL. To select a ST STM32F207IG as target device, the command line should look as below.

For a list of all supported device names, please refer to <Ref>

Syntax

```
-device <DeviceID>
```

Example

```
-device STM32F207IG
```

3.7.2.3 itmmask

Defines a set of stimulusports from which SWO data is received and displayed by SWO Viewer.

If itmmask is given, itmport will be ignored.

Syntax

```
-itmmask <Mask>
```

Example

Listen on ports 0 and 2

```
-itmmask 0x5
```

3.7.2.4 itmport

Defines the stimulus port from which SWO data is received and displayed by the SWO Viewer. Default is stimulus port 0. The command line should look as below.

Syntax

```
-itmport <ITMPortIndex>
```

Example

```
-itmport 0
```

3.7.2.5 outputfile

Define a file to which the output of SWO Viewer is printed.

Syntax

```
-outputfile <PathToFile>
```

Example

```
-outputfile "C:\Temp\Output.log"
```

3.7.2.6 settingsfile

Select a J-Link settings file to use for the target device.

Syntax

```
-settingsfile <PathToFile>
```

Example

```
-settingsfile "C:\Temp\Settings.jlink"
```

3.7.2.7 swofreq

Define the SWO frequency that shall be used by J-Link SWO Viewer for sampling SWO data.

Usually not necessary to define since optimal SWO speed is calculated automatically based on the CPU frequency and the capabilities of the connected J-Link.

Syntax

```
-swofreq <SWOFreq>
```

Example

```
-swofreq 6000
```

3.7.3 Configure SWO output after device reset

In some situations it might happen that the target application is reset and it is desired to log the SWO output of the target after reset during the booting process. For such situations, the target application itself needs to initialize the CPU for SWO output, since the SWO Viewer is not restarted but continuously running.

Example code for enabling SWO out of the target application

```
#define ITM_ENA      (*(volatile unsigned int*)0xE0000E00) // ITM Enable
#define ITM_TPR     (*(volatile unsigned int*)0xE0000E40) // Trace Privilege Register
#define ITM_TCR     (*(volatile unsigned int*)0xE0000E80) // ITM Trace Control Reg.
#define ITM_LSR     (*(volatile unsigned int*)0xE0000FB0) // ITM Lock Status Register
#define DHCSR      (*(volatile unsigned int*)0xE000EDF0) // Debug register
#define DEMCR      (*(volatile unsigned int*)0xE000EDFC) // Debug register
#define TPIU_ACPR  (*(volatile unsigned int*)0xE0040010) // Async Clock          \
// prescaler register
#define TPIU_SPPR  (*(volatile unsigned int*)0xE00400F0) // Selected Pin Protocol  \
// Register
#define DWT_CTRL   (*(volatile unsigned int*)0xE0001000) // DWT Control Register
#define FFCR       (*(volatile unsigned int*)0xE0040304) // Formatter and flush    \
// Control Register

U32 _ITMPort = 0; // The stimulus port from which SWO data is received and displayed.
U32 TargetDiv = 1; // Has to be calculated according to
// the CPU speed and the output baud rate

static void _EnableSWO() {
    U32 StimulusRegs;
    //
    // Enable access to SWO registers
    //
    DEMCR |= (1 << 24);
    ITM_LSR = 0xC5ACCE55;
    //
    // Initially disable ITM and stimulus port
    // To make sure that nothing is transferred via SWO
    // when changing the SWO prescaler etc.
    //
    Stimulusregs = ITM_ENA;
    StimulusRegs &= ~(1 << _ITMPort);
    ITM_ENABLE = StimulusRegs; // Disable ITM stimulus port
    ITM_TCR = 0; // Disable ITM
    //
    // Initialize SWO (prescaler, etc.)
    //
    TPIU_SPPR = 0x00000002; // Select NRZ mode
    TPIU_ACPR = TargetDiv - 1; // Example: 72/48 = 1,5 MHz
    ITM_TPR = 0x00000000;
    DWT_CTRL = 0x400003FE;
    FFCR = 0x00000100;
    //
    // Enable ITM and stimulus port
    //
    ITM_TCR = 0x1000D; // Enable ITM
    ITM_ENA = StimulusRegs | (1 << _ITMPort); // Enable ITM stimulus port
}
}
```

3.7.4 Target example code for terminal output

```
/*
 * SEGGER MICROCONTROLLER GmbH & Co KG
 * Solutions for real time microcontroller applications
 *
 * (c) 2012-2013 SEGGER Microcontroller GmbH & Co KG
 *
 * www.segger.com Support: support@segger.com
 */
```

```

*
*
*****
-----
File      : SWO.c
Purpose  : Simple implementation for output via SWO for Cortex-M processors.
           It can be used with any IDE. This sample implementation ensures that
           output via SWO is enabled in order to gurantee that the application
           does not hang.

-----  END-OF-HEADER  -----
*/

/*****
*
*      Prototypes (to be placed in a header file such as SWO.h)
*/
void SWO_PrintChar (char c);
void SWO_PrintString(const char *s);

/*****
*
*      Defines for Cortex-M debug unit
*/
#define ITM_STIM_U32 (*(volatile unsigned int*)0xE0000000) // STIM word access
#define ITM_STIM_U8  (*(volatile          char*)0xE0000000) // STIM Byte access
#define ITM_ENA      (*(volatile unsigned int*)0xE0000E00) // ITM Enable Reg.
#define ITM_TCR      (*(volatile unsigned int*)0xE0000E80) // ITM Trace Control Reg.

/*****
*
*      SWO_PrintChar()
*
* Function description
* Checks if SWO is set up. If it is not, return,
* to avoid program hangs if no debugger is connected.
* If it is set up, print a character to the ITM_STIM register
* in order to provide data for SWO.
* Parameters
* c:   The Chacacter to be printed.
* Notes
* Additional checks for device specific registers can be added.
*/
void SWO_PrintChar(char c) {
    //
    // Check if ITM_TCR.ITMENA is set
    //
    if ((ITM_TCR & 1) == 0) {
        return;
    }
    //
    // Check if stimulus port is enabled
    //
    if ((ITM_ENA & 1) == 0) {
        return;
    }
    //
    // Wait until STIMx is ready,
    // then send data
    //
    while ((ITM_STIM_U8 & 1) == 0);
    ITM_STIM_U8 = c;
}

```

```
/******  
*  
*     SWO_PrintString()  
*  
* Function description  
*   Print a string via SWO.  
*  
*/  
void SWO_PrintString(const char *s) {  
    //  
    // Print out character per character  
    //  
    while (*s) {  
        SWO_PrintChar(*s++);  
    }  
}
```

3.8 SWO Analyzer

SWO Analyzer (`SWOAnalyzer.exe`) is a tool that analyzes SWO output. Status and summary of the analysis are output to standard out, the details of the analysis are stored in a file.

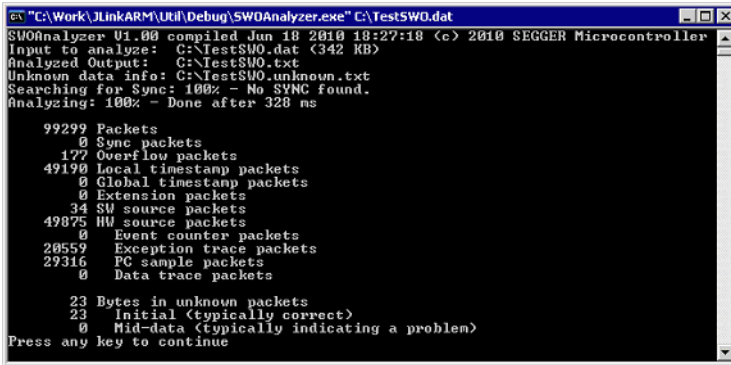

```

C:\Work\JLinkARM\Util\Debug\SWOAnalyzer.exe C:\TestSWO.dat
SWOAnalyzer V1.00 compiled Jun 18 2010 18:27:18 (c) 2010 SEGGER Microcontroller
Input to analyze: C:\TestSWO.dat (342 KB)
Analyzed Output: C:\TestSWO.txt
Unknown data info: C:\TestSWO.unknown.txt
Searching for Sync: 100% - No SYNC found.
Analyzing: 100% - Done after 328 ms

99299 Packets
 0 Sync packets
177 Overflow packets
49190 Local timestamp packets
 0 Global timestamp packets
 0 Extension packets
 34 SU source packets
49875 HU source packets
 0 Event counter packets
20559 Exception trace packets
29316 PC sample packets
 0 Data trace packets

23 Bytes in unknown packets
23 Initial (typically correct)
 0 Mid-data (typically indicating a problem)
Press any key to continue
  
```

Usage

```
SWOAnalyzer.exe <SWOfile>
```

This can be achieved by simply dragging the SWO output file created by the J-Link DLL onto the executable.

Creating an SWO output file

In order to create the SWO output file, which is the input file for the SWO Analyzer, the J-Link config file needs to be modified.

It should contain the following lines:

```
[SWO]
```

```
SWOLogFile="C:\TestSWO.dat"
```

3.9 JTAGLoad (Command line tool)

JTAGLoad is a tool that can be used to open an svf (Serial vector format) file. The data in the file will be sent to the target via J-Link / J-Trace.

A screenshot of a Windows command prompt window titled "JTAGLoad". The window has a blue title bar with standard minimize, maximize, and close buttons. The text inside the window is as follows:

```
SEGGER JTAG Load  
Compiled 13:33:56 on Dec  2 2005  
Executing file [C:\J_Trace.svf]...
```

3.10 J-Link RDI (Remote Debug Interface)

The J-Link RDI software is an remote debug interface for J-Link. It makes it possible to use J-Link with any RDI compliant debugger. The main part of the software is an RDI-compliant DLL, which needs to be selected in the debugger. There are two additional features available which build on the RDI software foundation. Each additional features requires an RDI license in addition to its own license. Evaluation licenses are available free of charge. For further information go to our website or contact us directly.

Note: The RDI software (as well as flash breakpoints and flash downloads) do not require a license if the target device is an LPC2xxx. In this case the software verifies that the target device is actually an LPC 2xxx and have a device-based license.

3.10.1 Flash download and flash breakpoints

Flash download and flash breakpoints are supported by J-Link RDI. For more information about flash download and flash breakpoints, please refer to *J-Link RDI User's Guide (UM08004)*, chapter *Flash download* and chapter *Breakpoints in flash memory*.

3.11 Processor specific tools

The J-Link software and documentation package includes some tools which support processor specific functionalities, like unlocking a device.

3.11.1 J-Link STR91x Commander (Command line tool)

J-Link STR91x Commander (`JLinkSTR91x.exe`) is a tool that can be used to configure STR91x cores. It permits some STR9 specific commands like:

- Set the configuration register to boot from bank 0 or 1
- Erase flash sectors
- Read and write the OTP sector of the flash
- Write-protect single flash sectors by setting the sector protection bits
- Prevent flash from communicate via JTAG by setting the security bit

All of the actions performed by the commands, excluding writing the OTP sector and erasing the flash, can be undone. This tool can be used to erase the flash of the controller even if a program is in flash which causes the CPU core to stall.

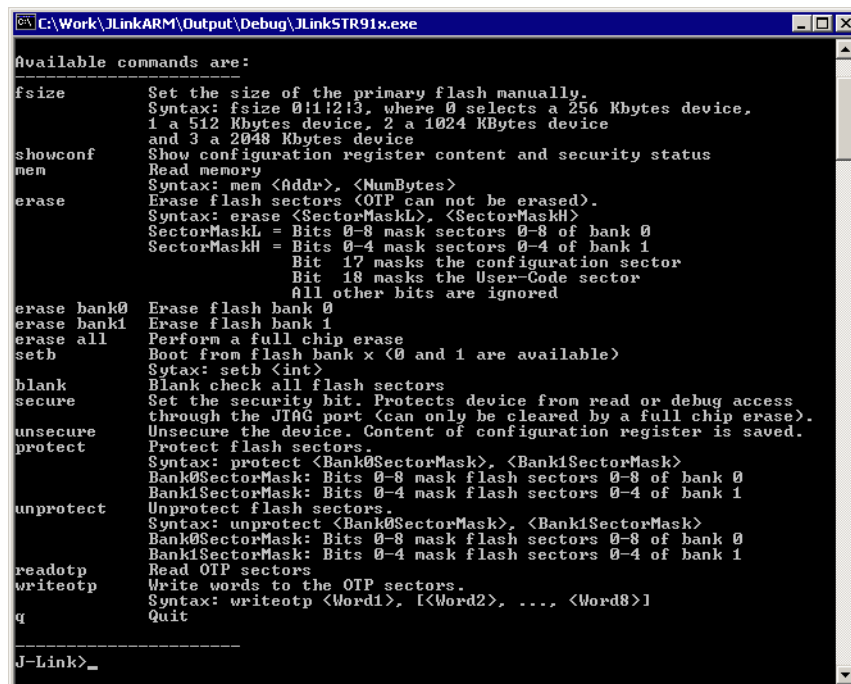

```

C:\Work\JLinkARM\Output\Debug\JLinkSTR91x.exe
Available commands are:
-----
fsize      Set the size of the primary flash manually.
           Syntax: fsize 0|1|2|3, where 0 selects a 256 Kbytes device,
           1 a 512 Kbytes device, 2 a 1024 Kbytes device
           and 3 a 2048 Kbytes device
showconf   Show configuration register content and security status
mem        Read memory
           Syntax: mem <Addr>, <NumBytes>
erase      Erase flash sectors (OTP can not be erased).
           Syntax: erase <SectorMaskL>, <SectorMaskH>
           SectorMaskL = Bits 0-8 mask sectors 0-8 of bank 0
           SectorMaskH = Bits 0-4 mask sectors 0-4 of bank 1
           Bit 17 masks the configuration sector
           Bit 18 masks the User-Code sector
           All other bits are ignored
erase bank0 Erase flash bank 0
erase bank1 Erase flash bank 1
erase all   Perform a full chip erase
setb        Boot from flash bank x (<0 and 1 are available>)
           Syntax: setb <int>
blank       Blank check all flash sectors
secure      Set the security bit. Protects device from read or debug access
           through the JTAG port (can only be cleared by a full chip erase).
unsecure    Unsecure the device. Content of configuration register is saved.
protect     Protect flash sectors.
           Syntax: protect <Bank0SectorMask>, <Bank1SectorMask>
           Bank0SectorMask: Bits 0-8 mask flash sectors 0-8 of bank 0
           Bank1SectorMask: Bits 0-4 mask flash sectors 0-4 of bank 1
unprotect   Unprotect flash sectors.
           Syntax: unprotect <Bank0SectorMask>, <Bank1SectorMask>
           Bank0SectorMask: Bits 0-8 mask flash sectors 0-8 of bank 0
           Bank1SectorMask: Bits 0-4 mask flash sectors 0-4 of bank 1
readotp     Read OTP sectors
writeotp    Write words to the OTP sectors.
           Syntax: writeotp <Word1>, [<Word2>, ..., <Word8>]
q           Quit

-----
J-Link>_

```

When starting the STR91x commander, a command sequence will be performed which brings MCU into Turbo Mode.

"While enabling the Turbo Mode, a dedicated test mode signal is set and controls the GPIOs in output. The IOs are maintained in this state until a next JTAG instruction is send." (ST Microelectronics)

Enabling Turbo Mode is necessary to guarantee proper function of all commands in the STR91x Commander.

3.11.1.1 Command line options

J-Link STR91x Commander can be started with different command line options. In the following, the command line options which are available for J-Link STR91x Commander are explained.

-CommandFile

Selects a command file and starts J-Link STR91x Commander in batch mode. The batch mode of J-Link Commander is similar to the execution of a batch file. The command file is parsed line by line and one command is executed at a time.

Syntax

```
-CommanderScript <CommandFilePath>
```

Example

See *Using command files* on page 64

-DRPre, -DRPost, -IRPre and -IRPost (Scan-Chain Configuration)

STR91x allows to configure a specific scan-chain via command-line. To use this feature four command line options has to be specified in order to allow a proper connection to the proper device. In case of passing an incomplete configuration, the utility tries to auto-detect.

Syntax

```
-DRPre <DRPre>
-DRPost <DRPost>
-IRPre <IRPre>
-IRPost <IRPost>
```

Example

```
JLink.exe -DRPre 1 -DRPost 4 -IRPre 16 -IRPost 20
```

-IP

Selects IP as host interface to connect to J-Link. Default host interface is USB.

Syntax

```
-IP <IPAddr>
```

Example

```
JLinkSTR91x.exe -IP 192.168.1.17
```

Additional information

To select from a list of all available emulators on Ethernet, please use * as <IPAddr>.

-SelectEmuBySN

Connect to a J-Link with a specific serial number via USB. Useful if multiple J-Links are connected to the same PC and multiple instances of J-Link STR91x Commander shall run and each connects to another J-Link.

Syntax

```
-SelectEmuBySN <SerialNo>
```

Example

```
JLinkSTR91x.exe -SelectEmuBySN 580011111
```

3.11.2 J-Link STM32 Unlock (Command line tool)

J-Link STM32 Unlock (`JLinkSTM32.exe`) is a free command line tool which can be used to disable the hardware watchdog of STM32 devices which can be activated by programming the option bytes. Moreover the J-Link STM32 Commander unsecures a read-protected STM32 device by re-programming the option bytes.

Note: Unprotecting a secured device or will cause a mass erase of the flash memory.



```
C:\Work\JLinkARM\Output\Release\JLinkSTM32.exe
SEGGER J-Link Unlock tool for STM32F10x devices
Compiled Apr 16 2009 09:59:58
(c) 2009 SEGGER Microcontroller GmbH & Co. KG, www.segger.com
Solutions for real time microcontroller applications

Connecting...O.K.
Performing init sequence...O.K.
SWD speed: 8000 kHz
Unlocking flash...O.K.
Press any key to exit.
-
```

3.12 J-Link Software Developer Kit (SDK)

The J-Link Software Developer Kit is needed if you want to write your own program with J-Link / J-Trace. The J-Link DLL is a standard Windows DLL typically used from C programs (Visual Basic or Delphi projects are also possible). It makes the entire functionality of J-Link / J-Trace available through its exported functions, such as halting/stepping the CPU core, reading/writing CPU and ICE registers and reading/writing memory. Therefore it can be used in any kind of application accessing an CPU core. The standard DLL does not have API functions for flash programming. However, the functionality offered can be used to program flash. In this case, a flash loader is required. The table below lists some of the included files and their respective purpose.

The J-Link SDK requires an additional license and is available upon request from www.segger.com.

Chapter 4

Setup

This chapter describes the setup procedure required in order to work with J-Link / J-Trace. Primarily this includes the installation of the J-Link software and documentation package, which also includes a kernel mode J-Link USB driver in your host system.

4.1 Installing the J-Link software and documentation pack

J-Link is shipped with a bundle of applications, corresponding manuals and some example projects and the kernel mode J-Link USB driver. Some of the applications require an additional license, free trial licenses are available upon request from www.segger.com.

Refer to chapter *J-Link software and documentation package* on page 61 for an overview about the J-Link software and documentation pack.

4.1.1 Setup procedure

To install the J-Link software and documentation pack, follow this procedure:

Note: We recommend to check if a newer version of the J-Link software and documentation pack is available for download before starting the installation. Check therefore the J-Link related download section of our website:

http://www.segger.com/download_jlink.html

1. Before you plug your J-Link / J-Trace into your computer's USB port, extract the setup tool `Setup_JLinkARM_V<VersionNumber>.zip`. The setup wizard will install the software and documentation pack that also includes the certified J-Link USB driver. Start the setup by double clicking `Setup_JLinkARM_V<VersionNumber>.exe`. The **license Agreement** dialog box will be opened. Accept the terms with the **Yes** button.

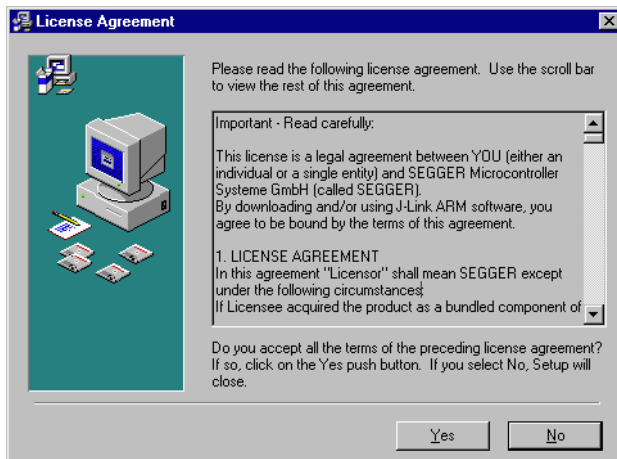

2. The **Welcome** dialog box is opened. Click **Next >** to open the **Choose Destination Location** dialog box.

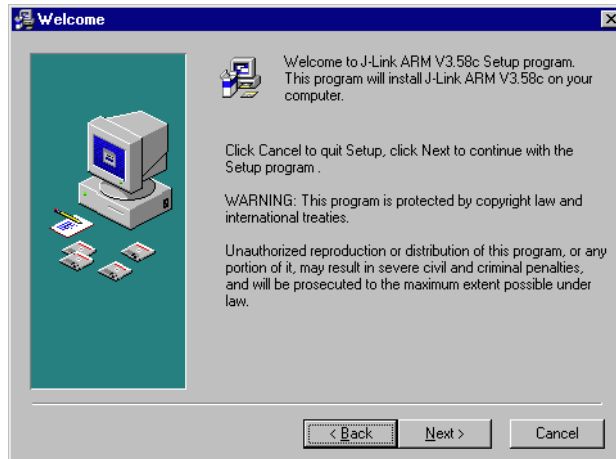

3. Accept the default installation path `C:\Program Files\SEGGER\JLinkARM_V<VersionNumber>` or choose an alternative location. Confirm your choice with the **Next >** button.

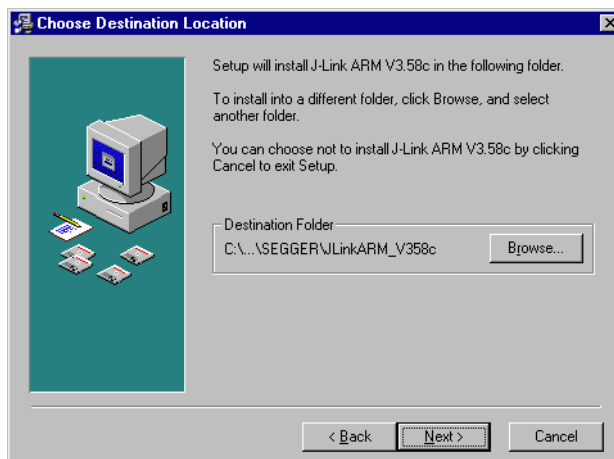

4. The **Choose options** dialog is opened. The **Install J-Link Serial Port Driver** installs the driver for J-Links with CDC functionality. It is not preselected since J-Links without CDC functionality do not need this driver. The **Create entry in start menu** creates a entry in start menu. It is preselected. The **Add shortcuts to desktop** option can be selected in order to create a shortcut on the desktop. Accept or deselect the options and confirm the selection with the **Next >** button.

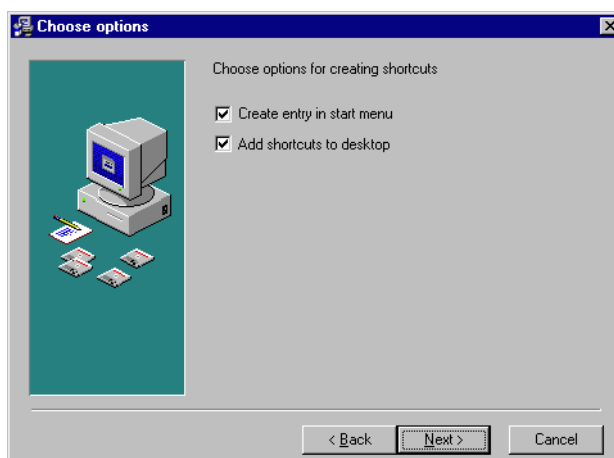

5. The installation process will be started.

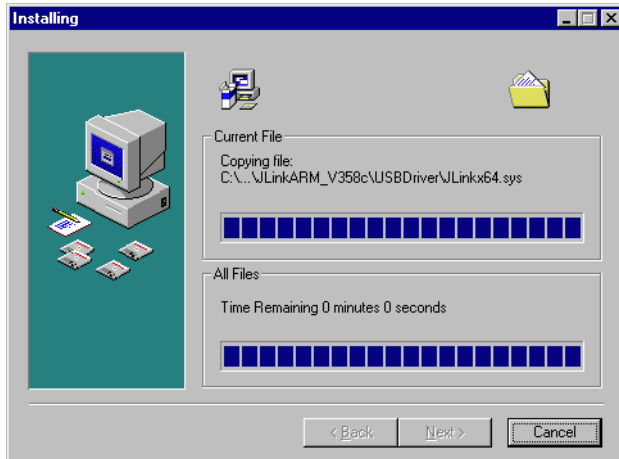

6. The J-Link DLL Updater pops up, which allows you to update the DLL of an installed IDE to the DLL version which is included in the installer. For further information about the J-Link DLL updater, please refer to *J-Link DLL updater* on page 131.

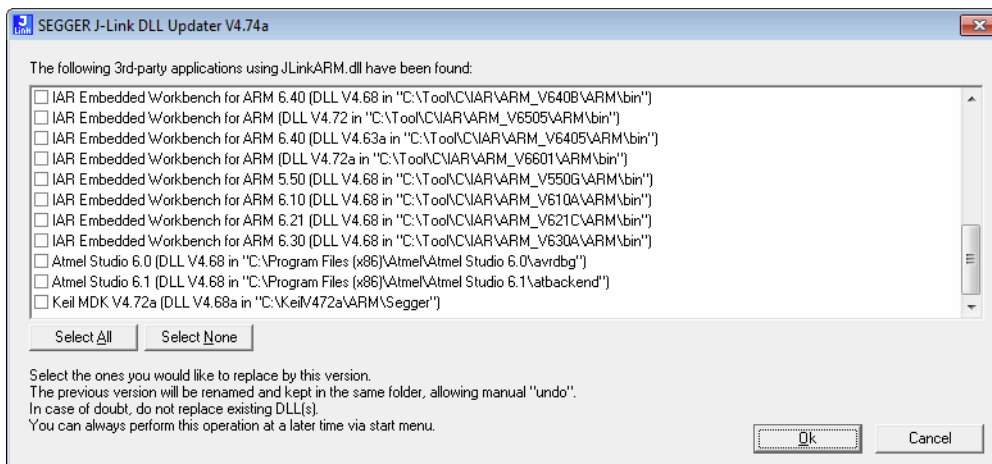

7. The **Installation Complete** dialog box appears after the copy process. Close the installation wizard with the **Finish >** button.

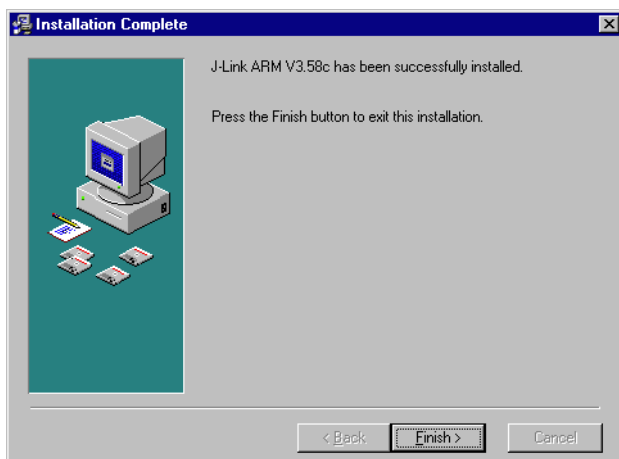

8. The J-Link software and documentation pack is successfully installed on your PC. Connect your J-Link via USB with your PC. The J-Link will be identified and after a short period the J-Link LED stops rapidly flashing and stays on permanently.

4.2 Setting up the USB interface

After installing the J-Link software and documentation package it should not be necessary to perform any additional setup sequences in order to configure the USB interface of J-Link.

4.2.1 Verifying correct driver installation

To verify the correct installation of the driver, disconnect and reconnect J-Link / J-Trace to the USB port. During the enumeration process which takes about 2 seconds, the LED on J-Link / J-Trace is flashing. After successful enumeration, the LED stays on permanently.

Start the provided sample application `JLink.exe`, which should display the compilation time of the J-Link firmware, the serial number, a target voltage of 0.000V, a complementary error message, which says that the supply voltage is too low if no target is connected to J-Link / J-Trace, and the speed selection. The screenshot below shows an example.

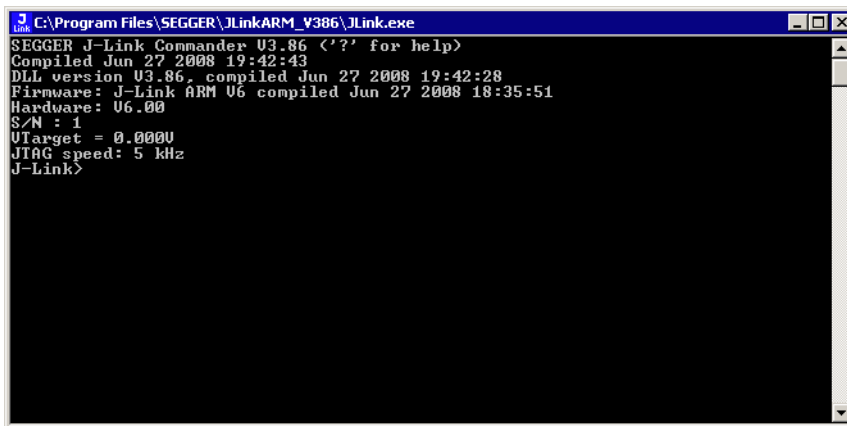

```

C:\Program Files\SEGGER\JLinkARM_V386\JLink.exe
SEGGER J-Link Commander V3.86 ('?' for help)
Compiled Jun 27 2008 19:42:43
DLL version V3.86, compiled Jun 27 2008 19:42:28
Firmware: J-Link ARM V6 compiled Jun 27 2008 18:35:51
Hardware: V6.00
S/N : 1
VTarget = 0.0000
JTAG speed: 5 kHz
J-Link>
  
```

In addition you can verify the driver installation by consulting the Windows device manager. If the driver is installed and your J-Link / J-Trace is connected to your computer, the device manager should list the J-Link USB driver as a node below "Universal Serial Bus controllers" as shown in the following screenshot:

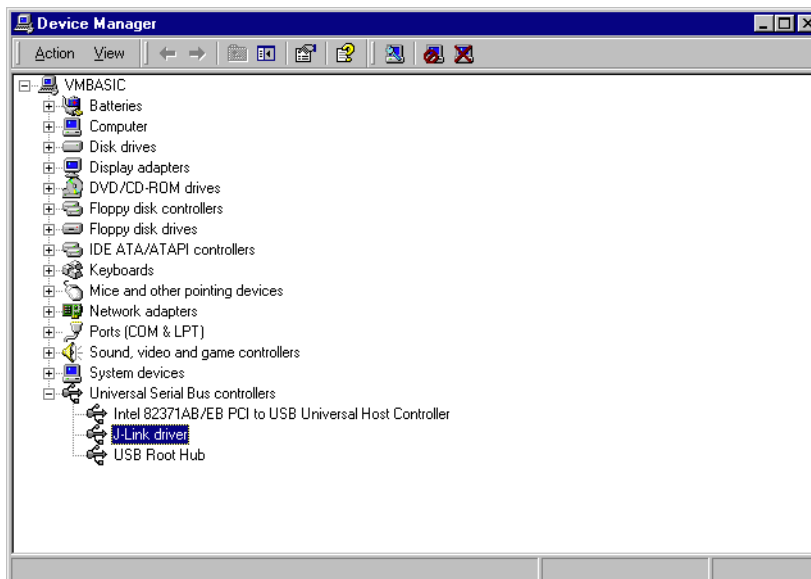

Right-click on the driver to open a context menu which contains the command **Properties**. If you select this command, a **J-Link driver Properties** dialog box is opened and should report: **This device is working properly**.

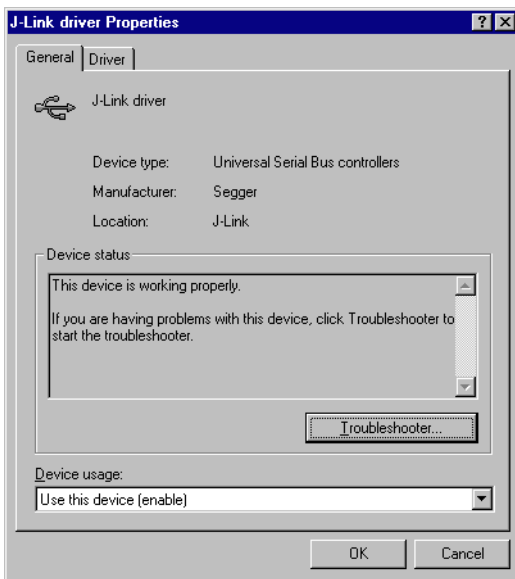

If you experience problems, refer to the chapter *Support and FAQs* on page 307 for help. You can select the **Driver** tab for detailed information about driver provider, version, date and digital signer.



4.2.2 Uninstalling the J-Link USB driver

If J-Link / J-Trace is not properly recognized by Windows and therefore does not enumerate, it makes sense to uninstall the J-Link USB driver.

This might be the case when:

- The LED on the J-Link / J-Trace is rapidly flashing.
- The J-Link / J-Trace is recognized as **Unknown Device** by Windows.

To have a clean system and help Windows to reinstall the J-Link driver, follow this procedure:

1. Disconnect J-Link / J-Trace from your PC.
2. Open the **Add/Remove Programs** dialog (Start > Settings > Control Panel > Add/Remove Programs) and select **Windows Driver Package - Segger**

(jlink) USB and click the **Change/Remove** button.

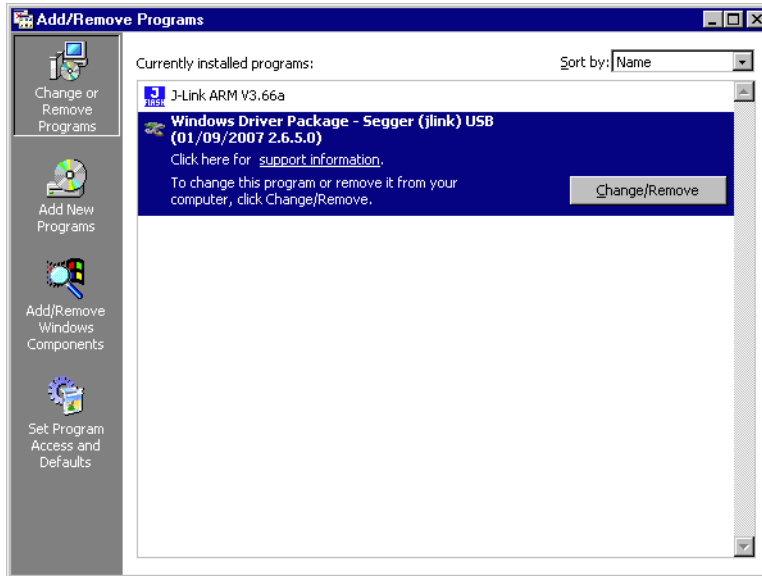

3. Confirm the uninstallation process.

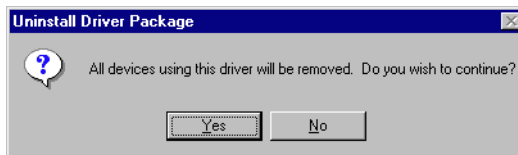

4.3 Setting up the IP interface

Some emulators of the J-Link family have (or future members will have) an additional Ethernet interface, to communicate with the host system. These emulators will also come with a built-in web server which allows configuration of the emulator via web interface. In addition to that, you can set a default gateway for the emulator which allows using it even in large intranets. For simplicity the setup process of J-Link Pro (referred to as J-Link) is described in this section.

4.3.1 Configuring J-Link using J-Link Configurator

The J-Link software and documentation package comes with a free GUI-based utility called J-Link Configurator which auto-detects all J-Links that are connected to the host PC via USB & Ethernet. The J-Link Configurator allows the user to setup the IP interface of J-Link. For more information about how to use the J-Link Configurator, please refer to *J-Link Configurator* on page 127.

4.3.2 Configuring J-Link using the webinterface

All emulators of the J-Link family which come with an Ethernet interface also come with a built-in web server, which provides a web interface for configuration. This enables the user to configure J-Link without additional tools, just with a simple web browser. The **Home** page of the web interface shows the serial number, the current IP address and the MAC address of the J-Link.

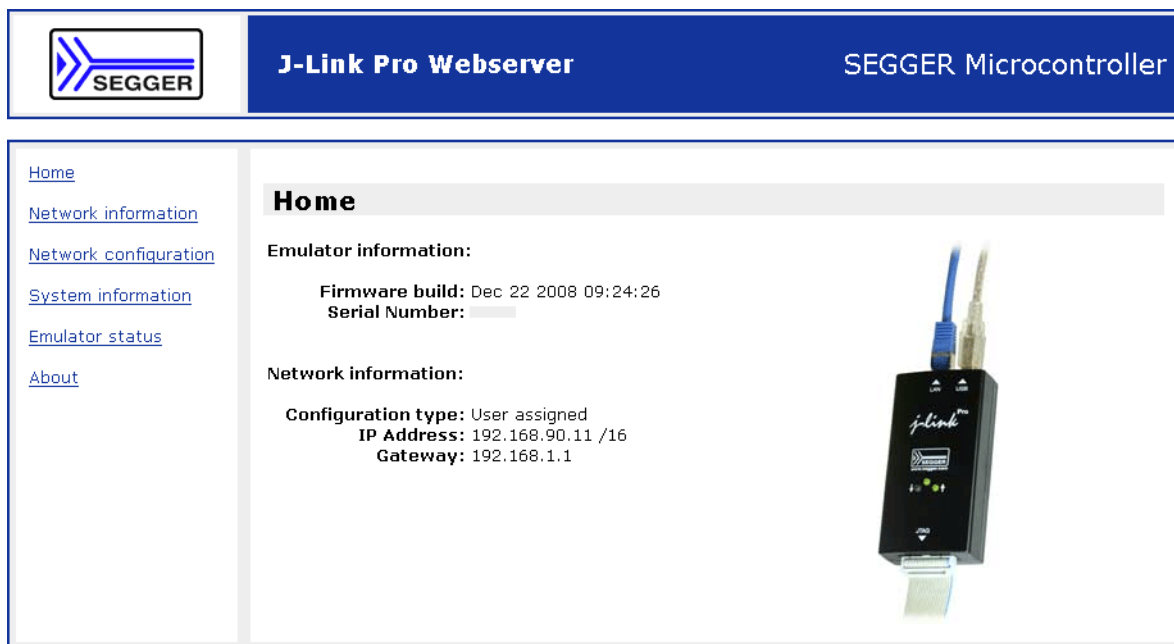

The screenshot shows the web interface for the J-Link Pro Webserver. The header includes the SEGGER logo, the text "J-Link Pro Webserver", and "SEGGER Microcontroller". The main content area is titled "Home" and displays the following information:

- Emulator information:**
 - Firmware build: Dec 22 2008 09:24:26
 - Serial Number: [redacted]
- Network information:**
 - Configuration type: User assigned
 - IP Address: 192.168.90.11 /16
 - Gateway: 192.168.1.1

A photograph of the J-Link hardware device is shown on the right side of the page. The device is a small black rectangular unit with a blue Ethernet cable and a gold USB cable plugged into it. The J-Link logo is visible on the front of the device.

The **Network configuration** page allows configuration of network related settings (IP address, subnet mask, default gateway) of J-Link. The user can choose between **automatic** IP assignment (settings are provided by a DHCP server in the network) and **manual** IP assignment by selecting the appropriate radio button.

	J-Link Pro Webserver	SEGGER Microcontroller
---	-----------------------------	------------------------

Home	<h3>Network configuration</h3> <p><input type="radio"/> Automatic <input checked="" type="radio"/> Manual</p> <p><input checked="" type="checkbox"/> DHCP</p> <p>IP address: <input type="text" value="192"/> . <input type="text" value="168"/> . <input type="text" value="90"/> . <input type="text" value="11"/></p> <p>Subnet mask: <input type="text" value="255"/> . <input type="text" value="255"/> . <input type="text" value="0"/> . <input type="text" value="0"/></p> <p>Gateway: <input type="text" value="192"/> . <input type="text" value="168"/> . <input type="text" value="1"/> . <input type="text" value="1"/></p> <p><input type="button" value="Change"/></p>
Network information	
Network configuration	
System information	
Emulator status	
About	

4.4 FAQs

Q: How can I use J-Link with GDB and Ethernet?

A: You have to use the J-Link GDB Server in order to connect to J-Link via GDB and Ethernet.

4.5 J-Link Configurator

Normally, no configuration is required, especially when using J-Link via USB. For special cases like: having multiple older J-Links connected to the same host PC in parallel, they need to be re-configured to be identified by their real serial number when enumerating on the host PC. This is the default identification method for current J-Links (J-Link with hardware version 8 or later). For re-configuration of old J-Links or for configuration of the IP settings (use DHCP, IP address, subnet mask, ...) of a J-Link supporting the Ethernet interface, SEGGER provides a GUI-based tool, called J-Link Configurator. The J-Link Configurator is part of the J-Link software and documentation package and can be used free of charge.

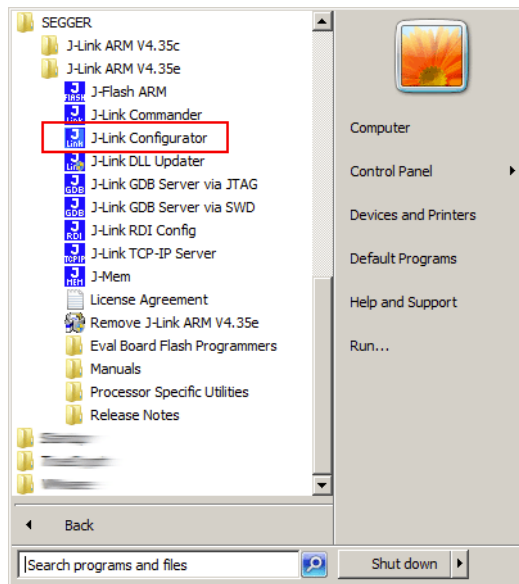

4.5.1 Configure J-Links using the J-Link Configurator

A J-Link can be easily configured by selecting the appropriate J-Link from the emulator list and using right click -> Configure.

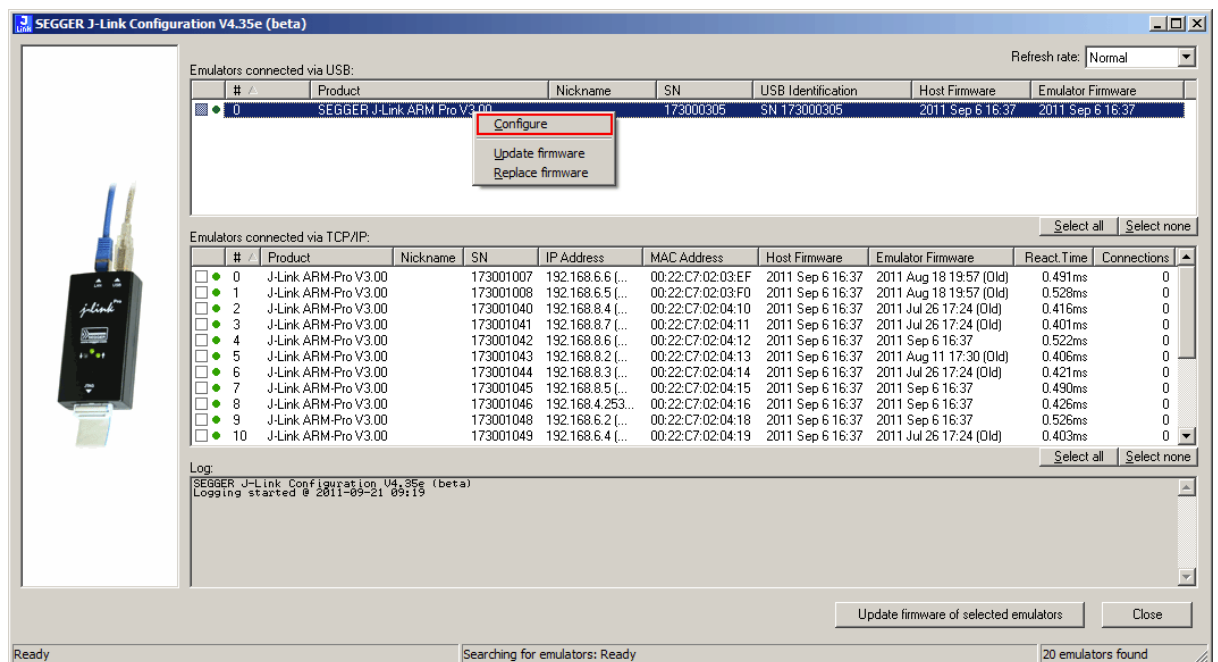

In order to configure a J-Link to use the new USB identification method (reporting the real serial number) simply select "Real SN" as USB identification method and click the OK button. The same dialog also allows configuration of the IP settings of the connected J-Link if it supports the Ethernet interface.

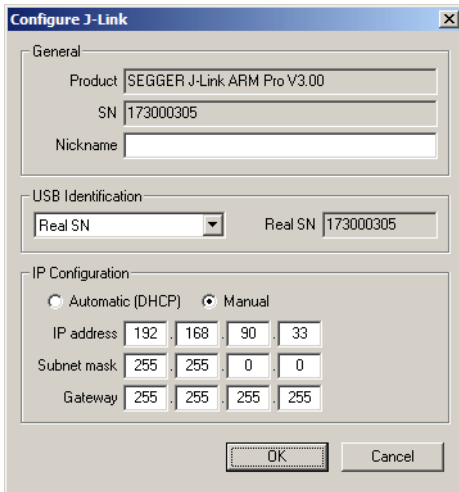

Note: When re-configuring older J-Links which use the old enumeration method (USB identification: USB 0 - USB 3) you can only have 1 J-Link connected which uses the old method at the same time. So re-configuration has to be done one at a time.

4.6 J-Link USB identification

In general, when using USB, there are two ways in which a J-Link can be identified:

- By serial number
- By USB address

Default configuration of J-Link is: Identification by serial number. Identification via USB address is used for compatibility and not recommended.

Background information

"USB address" really means changing the USB-Product Id (PID).

The following table shows how J-Links enumerate in the different identification modes.

Identification	PID	Serial number
Serial number (default)	0x0101	Serial number is real serial number of the J-Link or user assigned.
USB address 0 (Deprecated)	0x0101	123456
USB address 1 (Deprecated)	0x0102	123456
USB address 2 (Deprecated)	0x0103	123456
USB address 3 (Deprecated)	0x0104	123456

Table 4.1: J-Link enumeration in different identification modes

4.6.1 Connecting to different J-Links connected to the same host PC via USB

In general, when having multiple J-Links connected to the same PC, the J-Link to connect to is explicitly selected by its serial number. Most software/debuggers provide an extra field to type-in the serial number of the J-Link to connect to:

The following screenshot shows the connection dialog of the J-Flash software:

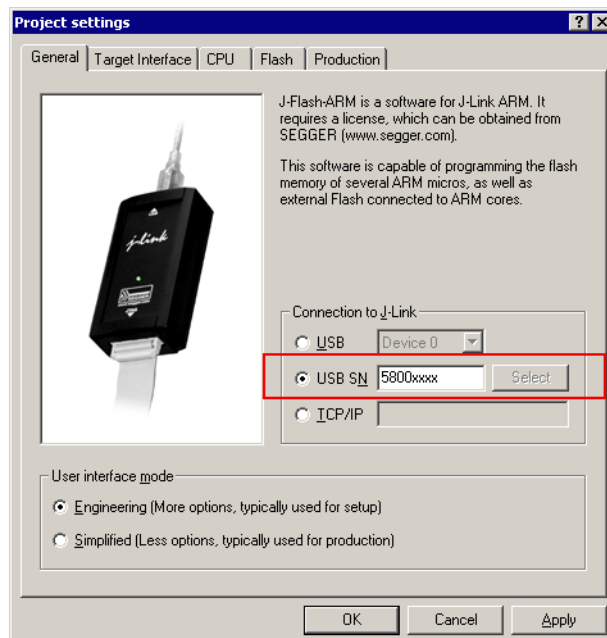

The following screenshot shows the connection dialog of IAR EWARM:

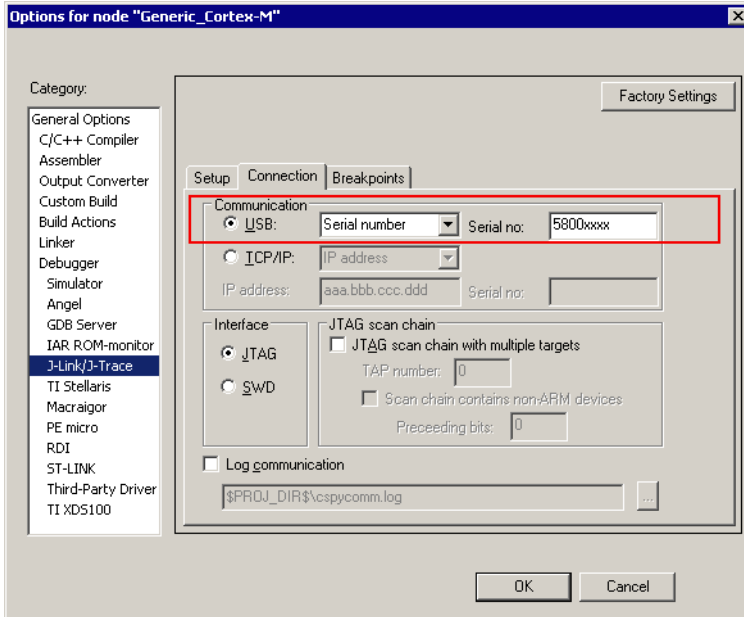

For debuggers / software which does not provide such a functionality, the J-Link DLL automatically detects that multiple J-Links are connected to the PC and shows a selection dialog which allows the user to select the appropriate J-Link he wants to connect to.

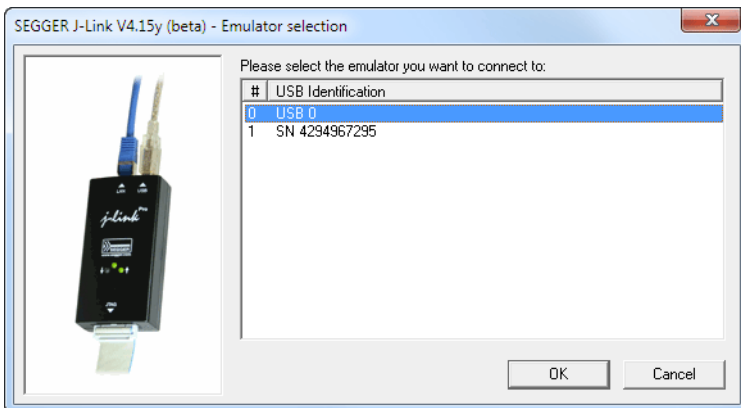

So even in IDEs which do not have an selection option for the J-Link, it is possible to connect to different J-Links.

4.7 Using the J-Link DLL

4.7.1 What is the JLink DLL?

The `J-LinkARM.dll` is a standard Windows DLL typically used from C or C++, but also Visual Basic or Delphi projects. It makes the entire functionality of the J-Link / J-Trace available through the exported functions.

The functionality includes things such as halting/stepping the ARM core, reading/writing CPU and ICE registers and reading/writing memory. Therefore, it can be used in any kind of application accessing a CPU core.

4.7.2 Updating the DLL in third-party programs

The JLink DLL can be used by any debugger that is designed to work with it. Some debuggers are usually shipped with the J-Link DLL already installed. Anyhow it may make sense to replace the included DLL with the latest one available, to take advantage of improvements in the newer version.

4.7.2.1 Updating the J-Link DLL in the IAR Embedded Workbench for ARM (EWARM)

It's recommended to use the J-Link DLL updater to update the J-Link DLL in the IAR Embedded Workbench. The IAR Embedded Workbench IDE is a high-performance integrated development environment with an editor, compiler, linker, debugger. The compiler generates very efficient code and is widely used. It comes with the `J-LinkARM.dll` in the `arm\bin` subdirectory of the installation directory. To update this DLL, you should backup your original DLL and then replace it with the new one.

Typically, the DLL is located in `C:\Program Files\IAR Systems\Embedded Workbench 6.n\arm\bin\`.

After updating the DLL, it is recommended to verify that the new DLL is loaded as described in *Determining which DLL is used by a program* on page 132.

J-Link DLL updater

The J-Link DLL updater is a tool which comes with the J-Link software and allows the user to update the `JLinkARM.dll` in all installations of the IAR Embedded Workbench, in a simple way. The updater is automatically started after the installation of a J-Link software version and asks for updating old DLLs used by IAR. The J-Link DLL updater can also be started manually. Simply enable the checkbox left to the IAR installation which has been found. Click **Ok** in order to update the `JLinkARM.dll` used by the IAR installation.

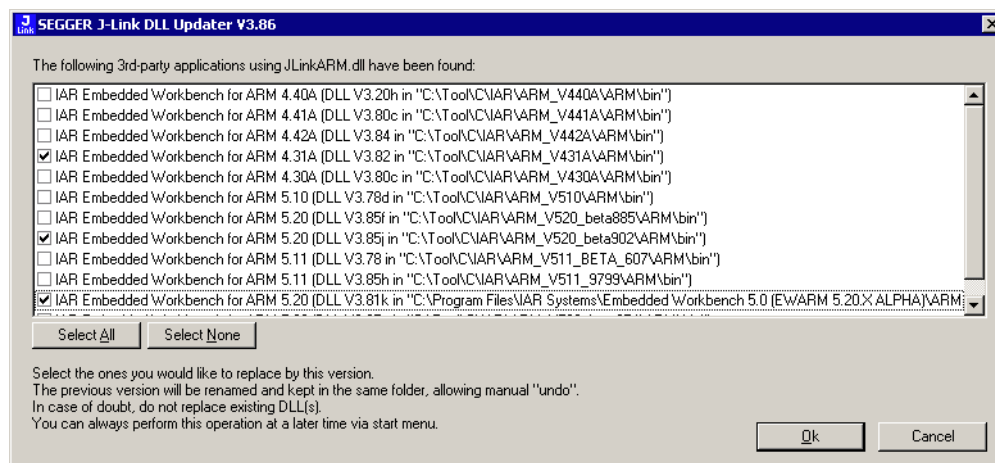

4.7.3 Determining the version of JLink DLL

To determine which version of the JLinkARM.dll you are facing, the DLL version can be viewed by right clicking the DLL in explorer and choosing **Properties** from the context menu. Click the **Version** tab to display information about the product version.

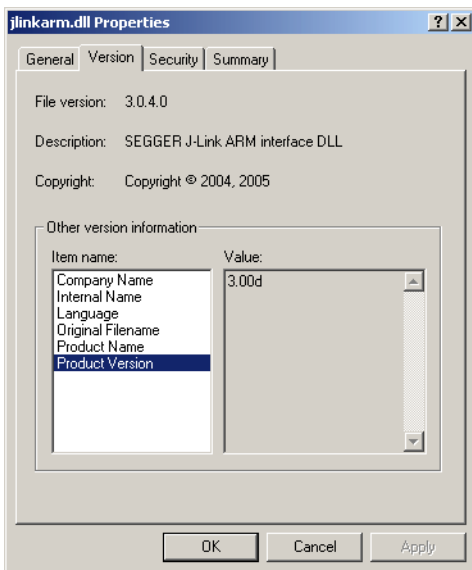

4.7.4 Determining which DLL is used by a program

To verify that the program you are working with is using the DLL you expect it to use, you can investigate which DLLs are loaded by your program with tools like Sysinternals' Process Explorer. It shows you details about the DLLs, used by your program, such as manufacturer and version.

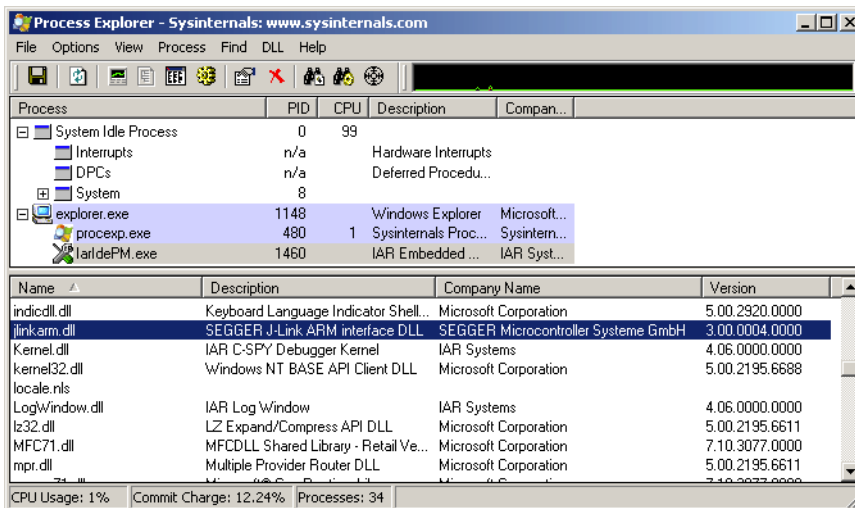

Process Explorer is - at the time of writing - a free utility which can be downloaded from www.sysinternals.com.

4.8 Getting started with J-Link and ARM DS-5

J-Link supports ARM DS-5 Development via the RDDI protocol.

For commercially using J-Link via RDDI in ARM DS-5, an RDI/RDDI license is required. J-Link models which come with an RDI license, can also be used via RDDI. RDDI can be evaluated free of charge.

In order to use J-Link in ARM DS-5 Development Studio, the RDDI DLL in DS-5 needs to be replaced by the SEGGER version of this DLL. The SEGGER version of the RDDI still allows using ARM's DSTREAM in DS-5. After installing the J-Link software and documentation package, the J-Link DLL Updater is started which allows easily updating the RDDI DLL in DS-5. An backup of the original DLL is made automatically.

4.8.1 Replacing the RDDI DLL manually

If J-Link DLL Updater is unable to find a DS-5 installation and does not list it for updating, the RDDI DLL can always be replaced manually. For more information about how to manually update the RDDI DLL, please refer to `$JLINK_INST_DIR$\RDDI\ManualInstallation.txt`.

4.8.2 Using J-Link in DS-5 Development Studio

Please follow the following steps, in order to use J-Link in DS-5, after replacing the RDDI DLL accordingly:

- Connect J-Link and target.
- Open ARM DS-5.
- Open DS-5 Project for target.
- Open **Debug Configurations...**
- Select DS-5 Debugger on the left side.
- Press **New** button.
- In the Connection tab, select The target from the device database, **Bare Metal Debug, Debug via DSTREAM/RVI**.
- Click on the **Browse...** button right to the Text box at the bottom **Connection**.
- In the Dialog select the J-Link which is connected to the target (e.g. **JLinkUSB:174200001**).

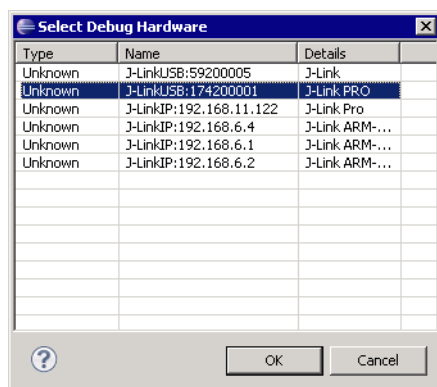

- Click **OK**.
- Add the device name to the connection string (e.g. **JLinkUSB:174200001:Device**

STM32F103ZG)

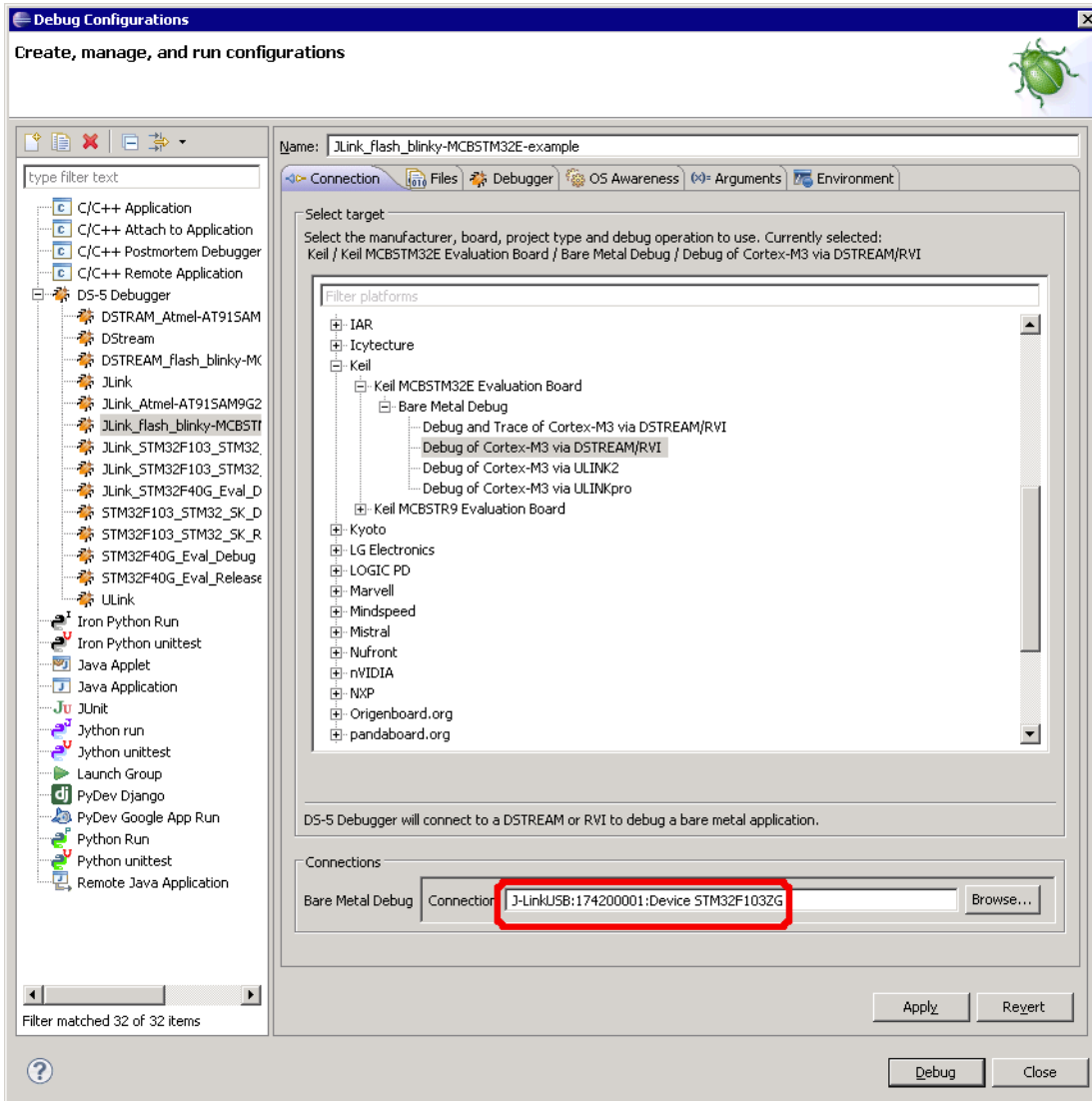

- Click **Apply**.
- In the **Files** tab, select the application to download.
- In the **Debugger** tab, select 'Debug from symbol' and enter main or select **Debug from entry point**.
- Click **Apply**.
- Start a new debug session with the newly created debug configuration.
- Now the debug session should start and downloaded the application to the target.

Chapter 5

Working with J-Link and J-Trace

This chapter describes functionality and how to use J-Link and J-Trace.

5.1 Connecting the target system

5.1.1 Power-on sequence

In general, J-Link / J-Trace should be powered on before connecting it with the target device. That means you should first connect J-Link / J-Trace with the host system via USB and then connect J-Link / J-Trace with the target device via JTAG. Power-on the device after you connected J-Link / J-Trace to it.

5.1.2 Verifying target device connection

If the USB driver is working properly and your J-Link / J-Trace is connected with the host system, you may connect J-Link / J-Trace to your target hardware. Then start `JLink.exe` which should now display the normal J-Link / J-Trace related information and in addition to that it should report that it found a JTAG target and the target's core ID. The screenshot below shows the output of `JLink.exe`. As can be seen, it reports a J-Link with one JTAG device connected.

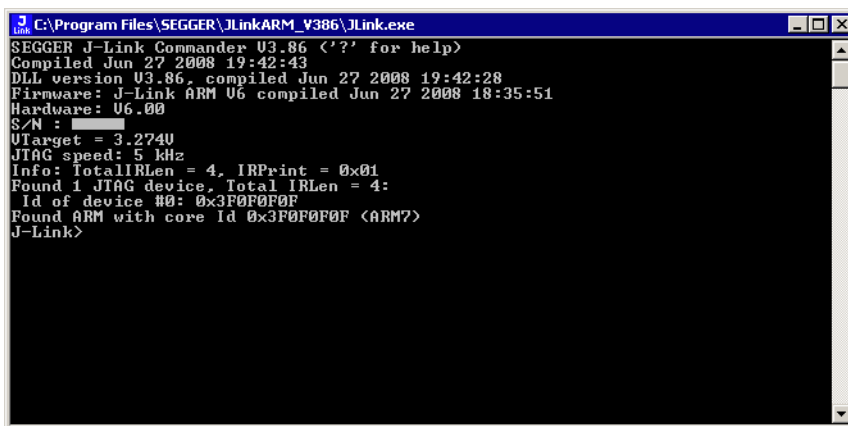

```
C:\Program Files\SEGGER\JLinkARM_V386\JLink.exe
SEGGER J-Link Commander V3.86 ('?' for help)
Compiled Jun 27 2008 19:42:43
DLL version V3.86, compiled Jun 27 2008 19:42:28
Firmware: J-Link ARM U6 compiled Jun 27 2008 18:35:51
Hardware: U6.00
S/N : 
UTarget = 3.2740
JTAG speed: 5 kHz
Info: TotalIRLen = 4, IRPrint = 0x01
Found 1 JTAG device, Total IRLen = 4:
  Id of device #0: 0x3F0F0F0F
Found ARM with core Id 0x3F0F0F0F <ARM?>
J-Link>
```

5.1.3 Problems

If you experience problems with any of the steps described above, read the chapter *Support and FAQs* on page 307 for troubleshooting tips. If you still do not find appropriate help there and your J-Link / J-Trace is an original SEGGER product, you can contact SEGGER support via e-mail. Provide the necessary information about your target processor, board etc. and we will try to solve your problem. A checklist of the required information together with the contact information can be found in chapter *Support and FAQs* on page 307 as well.

5.2 Indicators

J-Link uses indicators (LEDs) to give the user some information about the current status of the connected J-Link. All J-Links feature the main indicator. Some newer J-Links such as the J-Link Pro / Ultra come with additional input/output Indicators. In the following, the meaning of these indicators will be explained.

5.2.1 Main indicator

For J-Links up to V7, the main indicator is single color (Green). J-Link V8 comes with a bi-color indicator (Green & Red LED), which can show multiple colors: green, red and orange.

5.2.1.1 Single color indicator (J-Link V7 and earlier)

Indicator status	Meaning
GREEN, flashing at 10 Hz	Emulator enumerates.
GREEN, flickering	Emulator is in operation. Whenever the emulator is executing a command, the LED is switched off temporarily. Flickering speed depends on target interface speed. At low interface speeds, operations typically take longer and the "OFF" periods are typically longer than at fast speeds.
GREEN, constant	Emulator has enumerated and is in Idle mode.
GREEN, switched off for 10ms once per second	J-Link heart beat. Will be activated after the emulator has been in idle mode for at least 7 seconds.
GREEN, flashing at 1 Hz	Emulator has a fatal error. This should not normally happen.

Table 5.1: J-Link single color main indicator

5.2.1.2 Bi-color indicator (J-Link V8)

Indicator status	Meaning
GREEN, flashing at 10 Hz	Emulator enumerates.
GREEN, flickering	Emulator is in operation. Whenever the emulator is executing a command, the LED is switched off temporarily. Flickering speed depends on target interface speed. At low interface speeds, operations typically take longer and the "OFF" periods are typically longer than at fast speeds.
GREEN, constant	Emulator has enumerated and is in Idle mode.
GREEN, switched off for 10ms once per second	J-Link heart beat. Will be activated after the emulator has been in idle mode for at least 7 seconds.
ORANGE	Reset is active on target.
RED, flashing at 1 Hz	Emulator has a fatal error. This should not normally happen.

Table 5.2: J-Link single color LED main color indicator

5.2.2 Input indicator

Some newer J-Links such as the J-Link Pro/Ultra come with additional input/output Indicators. The input indicator is used to give the user some information about the status of the target hardware.

5.2.2.1 Bi-color input indicator

Indicator status	Meaning
GREEN	Target voltage could be measured. Target is connected.
ORANGE	Target voltage could be measured. RESET is pulled low (active) on target side.
RED	RESET is pulled low (active) on target side. If no target is connected, reset will be also active on target side.

Table 5.3: J-Link bi-color input indicator

5.2.3 Output indicator

Some newer J-Links such as the J-Link Pro/Ultra come with additional input/output Indicators. The output indicator is used to give the user some information about the emulator-to-target connection.

5.2.3.1 Bi-color output indicator

Indicator status	Meaning
OFF	Target power supply via Pin 19 is not active.
GREEN	Target power supply via Pin 19 is active.
ORANGE	Target power supply via Pin 19 is active. Emulator pulls RESET low (active).
RED	Emulator pulls RESET low (active).

Table 5.4: J-Link bi-color output indicator

5.3 JTAG interface

By default, only one device is assumed to be in the JTAG scan chain. If you have multiple devices in the scan chain, you must properly configure it. To do so, you have to specify the exact position of the CPU that should be addressed. Configuration of the scan chain is done by the target application. A target application can be a debugger such as the IAR C-SPY® debugger, ARM's AXD using RDI, a flash programming application such as SEGGER's J-Flash, or any other application using J-Link / J-Trace. It is the application's responsibility to supply a way to configure the scan chain. Most applications offer a dialog box for this purpose.

5.3.1 Multiple devices in the scan chain

J-Link / J-Trace can handle multiple devices in the scan chain. This applies to hardware where multiple chips are connected to the same JTAG connector. As can be seen in the following figure, the TCK and TMS lines of all JTAG device are connected, while the TDI and TDO lines form a bus.

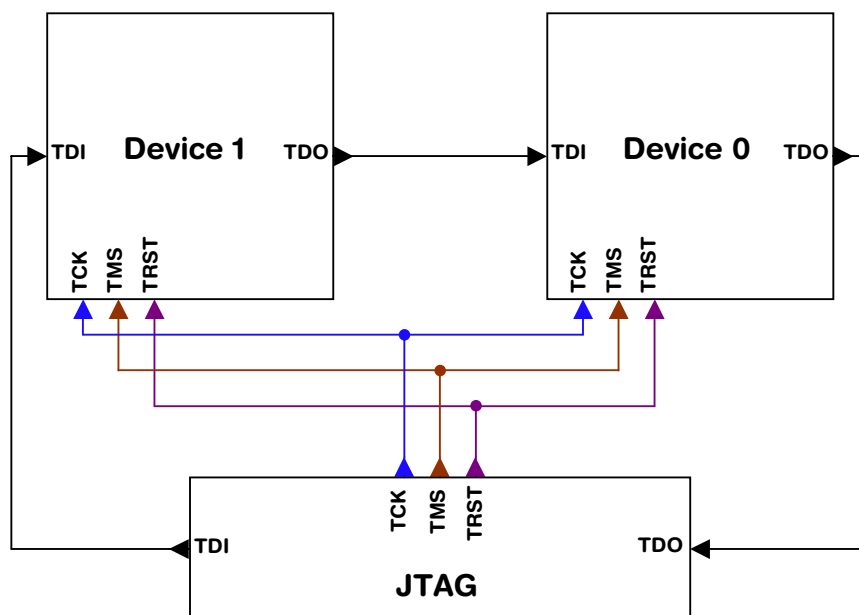

Currently, up to 8 devices in the scan chain are supported. One or more of these devices can be CPU cores; the other devices can be of any other type but need to comply with the JTAG standard.

5.3.1.1 Configuration

The configuration of the scan chain depends on the application used. Read *JTAG interface* on page 140 for further instructions and configuration examples.

5.3.2 Sample configuration dialog boxes

As explained before, it is responsibility of the application to allow the user to configure the scan chain. This is typically done in a dialog box; some sample dialog boxes are shown below.

SEGGER J-Flash configuration dialog

This dialog box can be found at **Options|Project** settings.

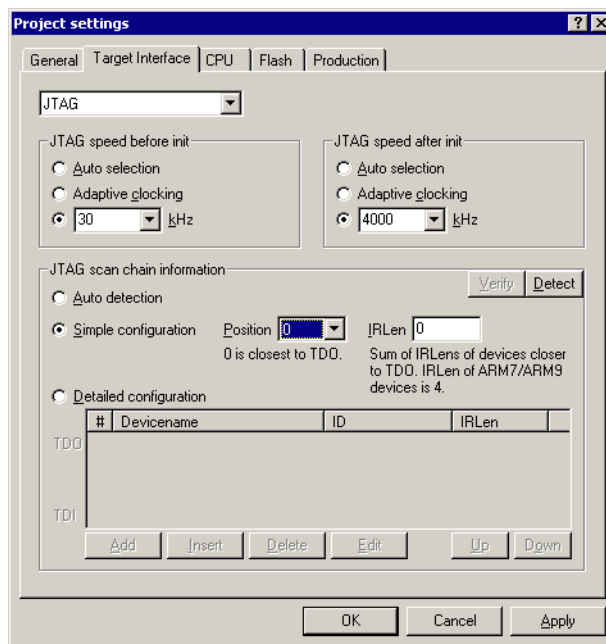

SEGGER J-Link RDI configuration dialog box

This dialog can be found under **RDI|Configure** for example in IAR Embedded Workbench®. For detailed information check the IAR Embedded Workbench user guide.

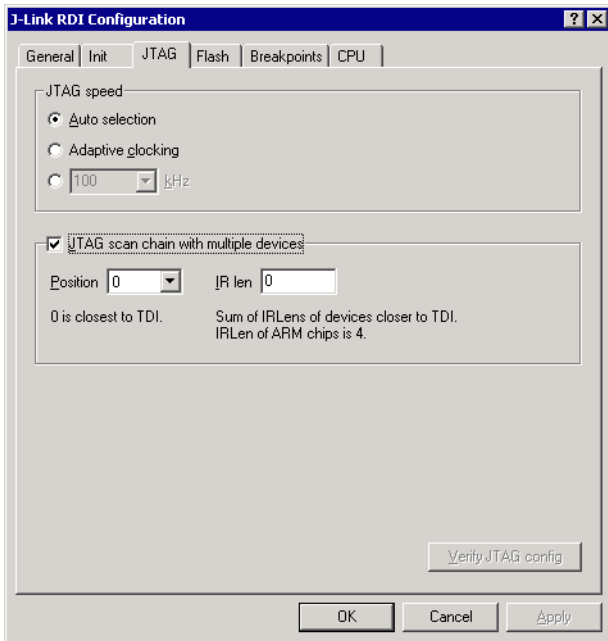

IAR J-Link configuration dialog box

This dialog box can be found under **Project|Options**.

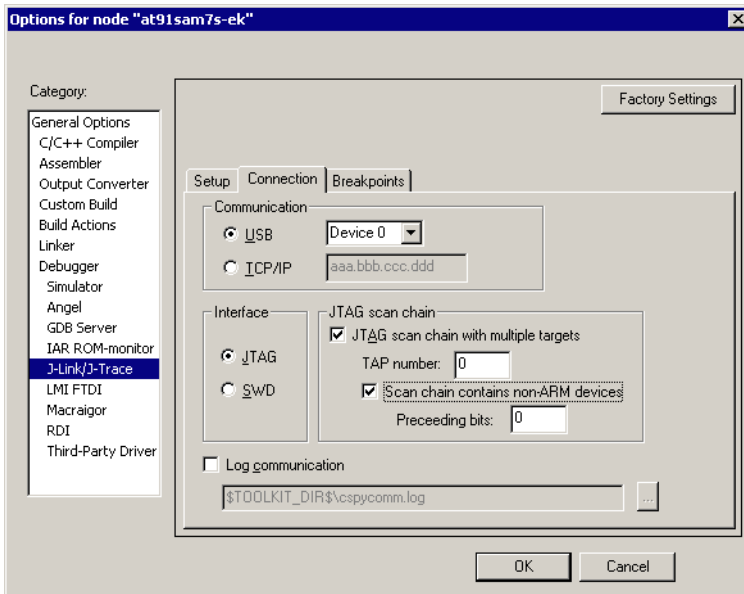

5.3.3 Determining values for scan chain configuration

When do I need to configure the scan chain?

If only one device is connected to the scan chain, the default configuration can be used. In other cases, J-Link / J-Trace may succeed in automatically recognizing the devices on the scan chain, but whether this is possible depends on the devices present on the scan chain.

How do I configure the scan chain?

2 values need to be known:

- The position of the target device in the scan chain
- The total number of bits in the instruction registers of the devices before the target device (IR len).

The position can usually be seen in the schematic; the IR len can be found in the manual supplied by the manufacturers of the others devices.

ARM7/ARM9 have an IR len of four.

Sample configurations

The diagram below shows a scan chain configuration sample with 2 devices connected to the JTAG port.

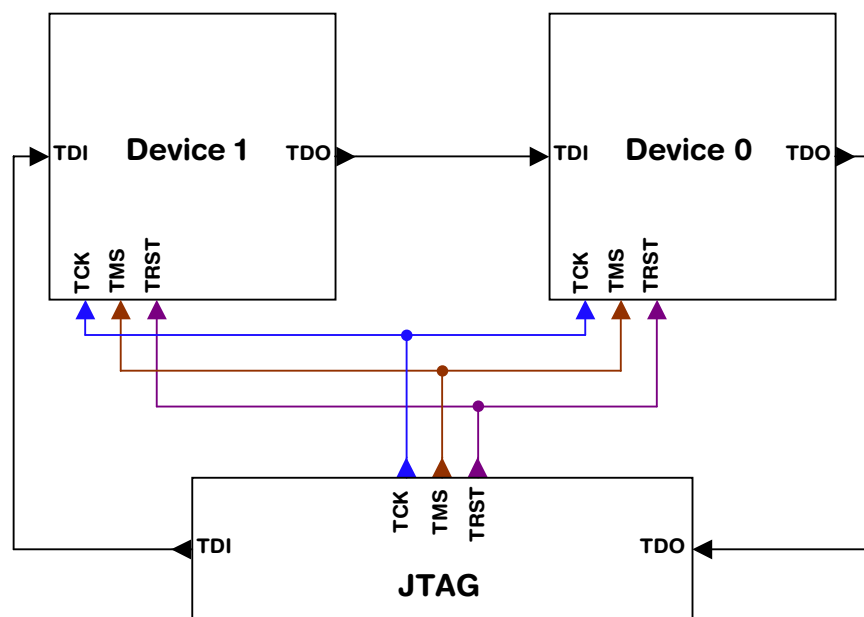

Examples

The following table shows a few sample configurations with 1,2 and 3 devices in different configurations.

Device 0 Chip(IR len)	Device 1 Chip(IR len)	Device 2 Chip(IR len)	Position	IR len
ARM (4)	-	-	0	0
ARM (4)	Xilinx(8)	-	0	0
Xilinx(8)	ARM (4)	-	1	8
Xilinx(8)	Xilinx(8)	ARM (4)	2	16

Table 5.5: Example scan chain configurations

Device 0 Chip(IR len)	Device 1 Chip(IR len)	Device 2 Chip(IR len)	Position	IR len
ARM(4)	Xilinx(8)	ARM(4)	0	0
ARM(4)	Xilinx(8)	ARM(4)	2	12
Xilinx(8)	ARM(4)	Xilinx(8)	1	8

Table 5.5: Example scan chain configurations

The target device is marked in blue.

5.3.4 JTAG Speed

There are basically three types of speed settings:

- Fixed JTAG speed
- Automatic JTAG speed
- Adaptive clocking.

These are explained below.

5.3.4.1 Fixed JTAG speed

The target is clocked at a fixed clock speed. The maximum JTAG speed the target can handle depends on the target itself. In general CPU cores without JTAG synchronization logic (such as ARM7-TDMI) can handle JTAG speeds up to the CPU speed, ARM cores with JTAG synchronization logic (such as ARM7-TDMI-S, ARM946E-S, ARM966EJ-S) can handle JTAG speeds up to 1/6 of the CPU speed.

JTAG speeds of more than 10 MHz are not recommended.

5.3.4.2 Automatic JTAG speed

Selects the maximum JTAG speed handled by the TAP controller.

Note: On ARM cores without synchronization logic, this may not work reliably, because the CPU core may be clocked slower than the maximum JTAG speed.

5.3.4.3 Adaptive clocking

If the target provides the RTCK signal, select the adaptive clocking function to synchronize the clock to the processor clock outside the core. This ensures there are no synchronization problems over the JTAG interface.

If you use the adaptive clocking feature, transmission delays, gate delays, and synchronization requirements result in a lower maximum clock frequency than with non-adaptive clocking.

5.4 SWD interface

The J-Link support ARM's Serial Wire Debug (SWD). SWD replaces the 5-pin JTAG port with a clock (SWDCLK) and a single bi-directional data pin (SWDIO), providing all the normal JTAG debug and test functionality. SWDIO and SWCLK are overlaid on the TMS and TCK pins. In order to communicate with a SWD device, J-Link sends out data on SWDIO, synchronous to the SWCLK. With every rising edge of SWCLK, one bit of data is transmitted or received on the SWDIO.

5.4.1 SWD speed

Currently only fixed SWD speed is supported by J-Link. The target is clocked at a fixed clock speed. The SWD speed which is used for target communication should not exceed **target CPU speed * 10**. The maximum SWD speed which is supported by J-Link depends on the hardware version and model of J-Link. For more information about the maximum SWD speed for each J-Link / J-Trace model, please refer to *J-Link / J-Trace models* on page 24.

5.4.2 SWO

Serial Wire Output (SWO) support means support for a single pin output signal from the core. The Instrumentation Trace Macrocell (ITM) and Serial Wire Output (SWO) can be used to form a Serial Wire Viewer (SWV). The Serial Wire Viewer provides a low cost method of obtaining information from inside the MCU.

Usually it should not be necessary to configure the SWO speed because this is usually done by the debugger.

5.4.2.1 Max. SWO speeds

The supported SWO speeds depend on the connected emulator. They can be retrieved from the emulator. To get the supported SWO speeds for your emulator, use J-Link Commander:

```
J-Link> si 1 //Select target interface SWD
J-Link> SWOSpeed
```

Currently, following speeds are supported:

Emulator	Speed formula	Resulting max. speed
J-Link V9	60MHz/n, n >= 8	7.5 MHz
J-Link Pro/ULTRA V4	3.2GHz/n, n >= 64	50 MHz

Table 5.6: J-Link supported SWO input speeds

5.4.2.2 Configuring SWO speeds

The max. SWO speed in practice is the max. speed which both, target and J-Link can handle. J-Link can handle the frequencies described in *SWO* on page 145 whereas the max. deviation between the target and the J-Link speed is about 3%.

The computation of possible SWO speeds is typically done in the debugger. The SWO output speed of the CPU is determined by TRACECLKIN, which is normally the same as the CPU clock.

Example1

Target CPU running at 72 MHz. n is between 1 and 8192.

Possible SWO output speeds are:

72MHz, 36MHz, 24MHz, ...

J-Link V9: Supported SWO input speeds are: 60MHz / n, n >= 8:

7.5MHz, 6.66MHz, 6MHz, ...

Permitted combinations are:

SWO output	SWO input	Deviation percent
6MHz, n = 12	6MHz, n = 10	0
4MHz, n = 18	4MHz, n = 15	0
...	...	<= 3
2MHz, n = 36	2MHz, n = 30	0
...

Table 5.7: Permitted SWO speed combinations

Example 2

Target CPU running at 10 MHz.

Possible SWO output speeds are:

10MHz, 5MHz, 3.33MHz, ...

J-Link V7: Supported SWO input speeds are: 6MHz / n, n >= 1:

6MHz, 3MHz, 2MHz, 1.5MHz, ...

Permitted combinations are:

SWO output	SWO input	Deviation percent
2MHz, n = 5	2MHz, n = 3	0
1MHz, n = 10	1MHz, n = 6	0
769kHz, n = 13	750kHz, n = 8	2.53
...

Table 5.8: Permitted SWO speed combinations

5.5 Multi-core debugging

J-Link / J-Trace is able to debug multiple cores on one target system connected to the same scan chain. Configuring and using this feature is described in this section.

5.5.1 How multi-core debugging works

Multi-core debugging requires multiple debuggers or multiple instances of the same debugger. Two or more debuggers can use the same J-Link / J-Trace simultaneously. Configuring a debugger to work with a core in a multi-core environment does not require special settings. All that is required is proper setup of the scan chain for each debugger. This enables J-Link / J-Trace to debug more than one core on a target at the same time.

The following figure shows a host, debugging two CPU cores with two instances of the same debugger.

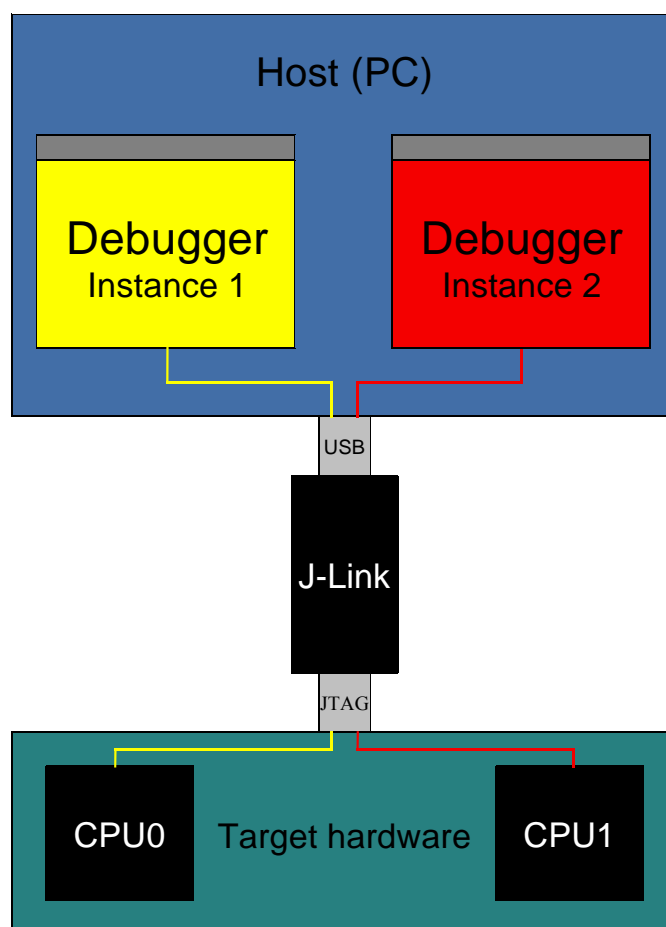

Both debuggers share the same physical connection. The core to debug is selected through the JTAG-settings as described below.

5.5.2 Using multi-core debugging in detail

1. Connect your target to J-Link / J-Trace.
2. Start your debugger, for example IAR Embedded Workbench for ARM.
3. Choose `Project|Options` and configure your scan chain. The picture below shows the configuration for the first CPU core on your target.

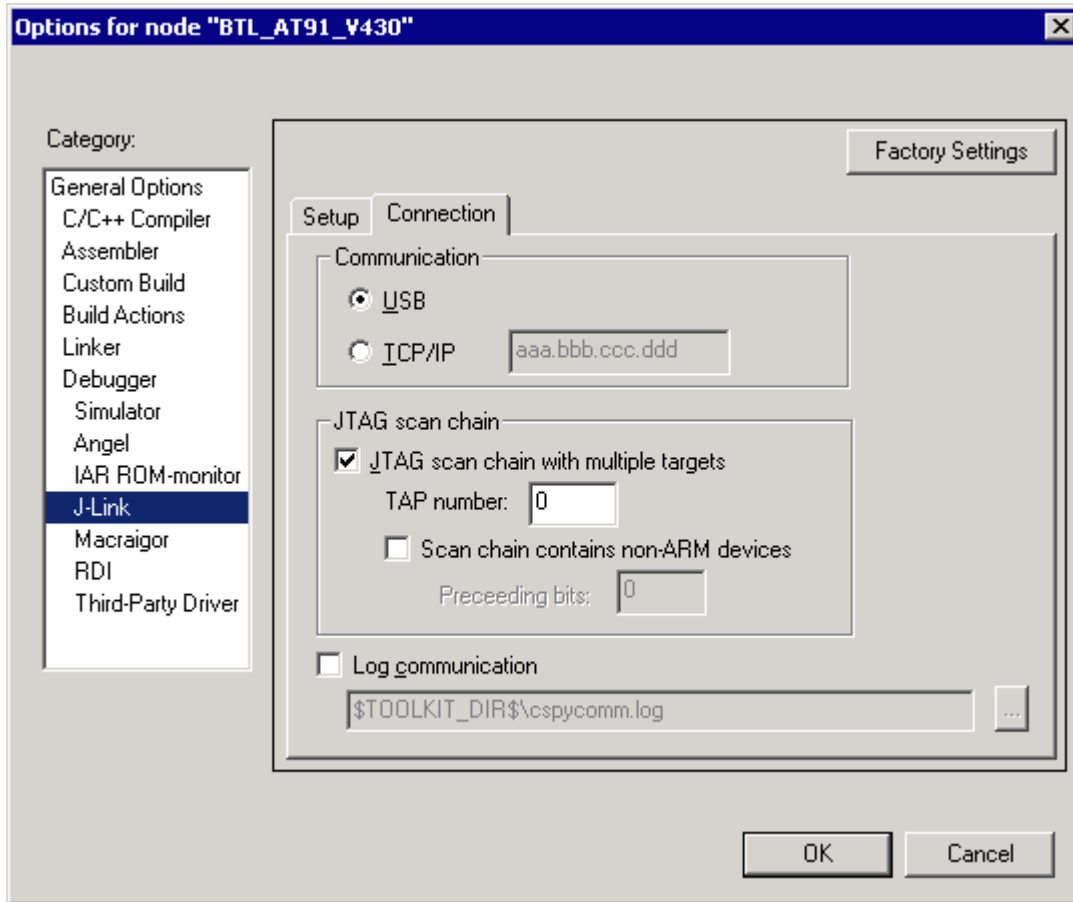

4. Start debugging the first core.
5. Start another debugger, for example another instance of IAR Embedded Workbench for ARM.

6. Choose `Project|Options` and configure your second scan chain. The following dialog box shows the configuration for the second ARM core on your target.

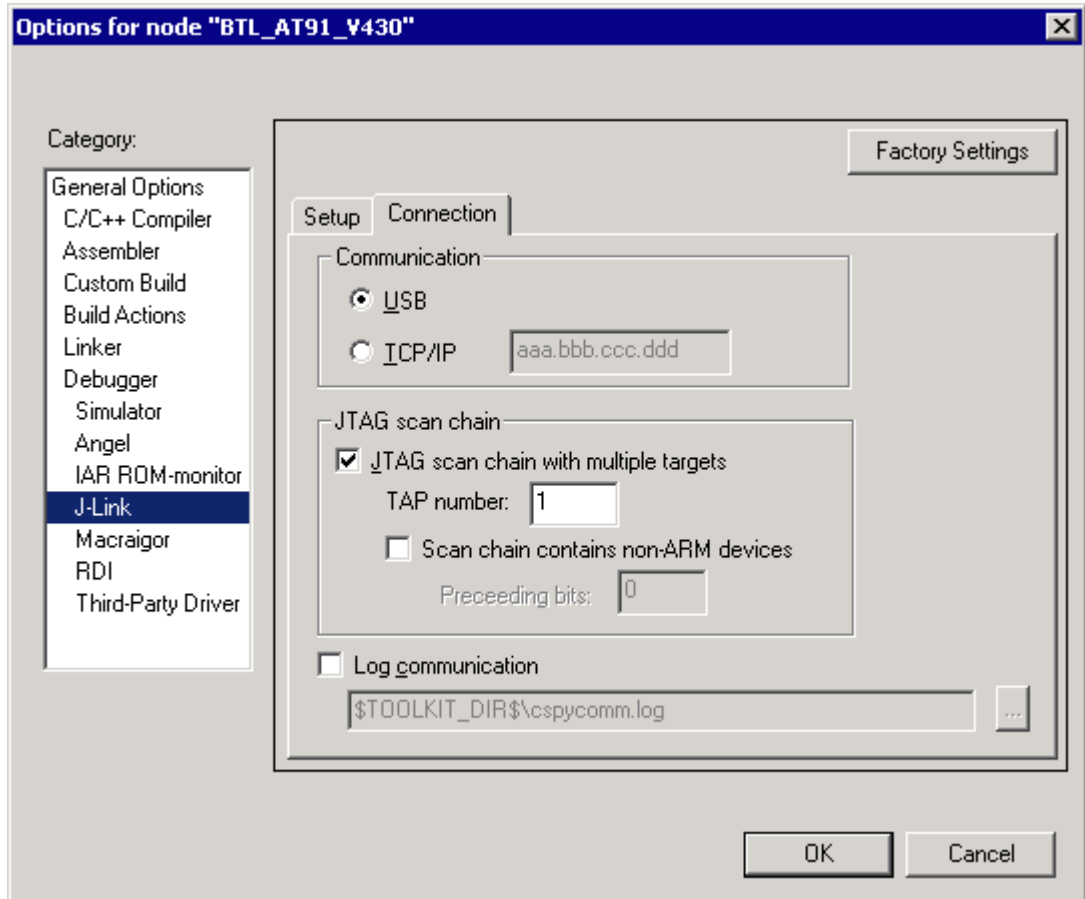

7. Start debugging your second core.

Example:

Core #1	Core #2	Core #3	TAP number debugger #1	TAP number debugger #2
ARM7TDMI	ARM7TDMI-S	ARM7TDMI	0	1
ARM7TDMI	ARM7TDMI	ARM7TDMI	0	2
ARM7TDMI-S	ARM7TDMI-S	ARM7TDMI-S	1	2

Table 5.9: Multicore debugging

Cores to debug are marked in blue.

5.5.3 Things you should be aware of

Multi-core debugging is more difficult than single-core debugging. You should be aware of the pitfalls related to JTAG speed and resetting the target.

5.5.3.1 JTAG speed

Each core has its own maximum JTAG speed. The maximum JTAG speed of all cores in the same chain is the minimum of the maximum JTAG speeds.

For example:

- Core #1: 2MHz maximum JTAG speed
- Core #2: 4MHz maximum JTAG speed
- Scan chain: 2MHz maximum JTAG speed

5.5.3.2 Resetting the target

All cores share the same RESET line. You should be aware that resetting one core through the RESET line means resetting all cores which have their RESET pins connected to the RESET line on the target.

5.6 Connecting multiple J-Links / J-Traces to your PC

In general, it is possible to have an unlimited number of J-Links / J-Traces connected to the same PC. Current J-Link models are already factory-configured to be used in a multi-J-Link environment, older J-Links can be re-configured to use them in a multi-J-link environment.

5.6.1 How does it work?

USB devices are identified by the OS by their product id, vendor id and serial number. The serial number reported by current J-Links is a unique number which allows to have an almost unlimited number of J-Links connected to the same host at the same time.

The sketch below shows a host, running two application programs. Each application-communicates with one CPU core via a separate J-Link.

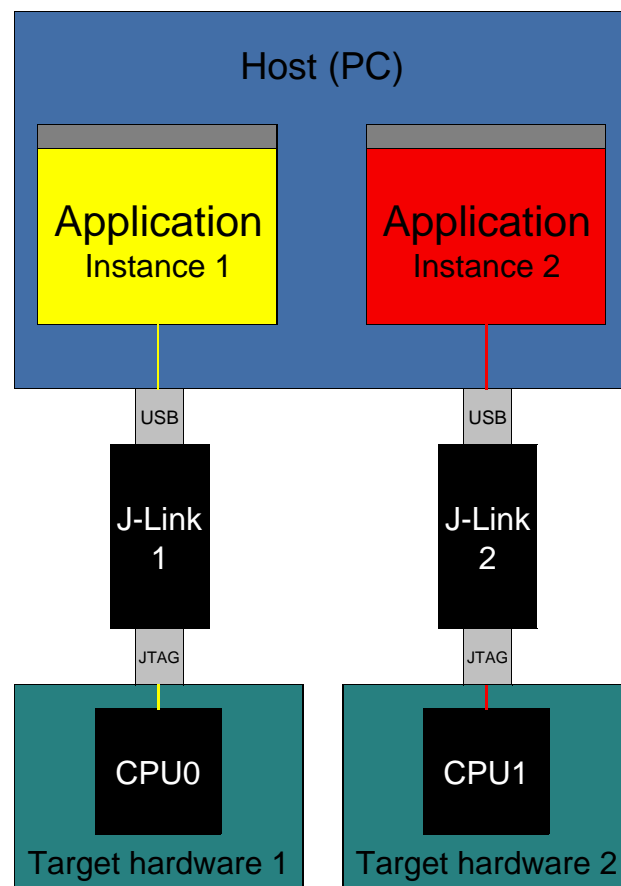

Older J-Links / J-Traces all reported the same serial number which made it necessary to configure them for USB0-3 if multiple J-Link should be connected to the same PC in parallel.

For these J-Links, we recommend to re-configure them to use the new enumeration method (report real serial number).

Re-configuration can be done by using the J-Link Configurator, which is part of the J-Link software and documentation package.

Re-configuring J-Link to use the new method does not have any bad side-effects on the current debug environment. Usually the user does not see any difference as long as only one emulator is connected.

In order to re-configure a J-Link to use the new USB identification method use the J-Link Configurator which comes with the J-Link software and documentation package. For more information about the J-Link Configurator and how to use it, please refer to *J-Link Configurator* on page 127.

5.7 J-Link control panel

Since software version V3.86 J-Link the J-Link control panel window allows the user to monitor the J-Link status and the target status information in real-time. It also allows the user to configure the use of some J-Link features such as flash download, flash breakpoints and instruction set simulation. The J-Link control panel window can be accessed via the J-Link tray icon in the tray icon list. This icon is available when the debug session is started.



To open the status window, simply click on the tray icon.

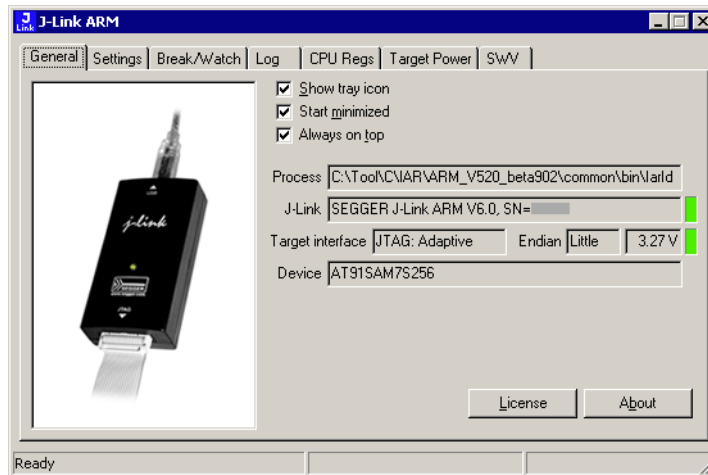

5.7.1 Tabs

The J-Link status window supports different features which are grouped in tabs. The organization of each tab and the functionality which is behind these groups will be explained in this section

5.7.1.1 General

In the **General** section, general information about J-Link and the target hardware are shown. Moreover the following general settings can be configured:

- **Show tray icon:** If this checkbox is disabled the tray icon will not show from the next time the DLL is loaded.
- **Start minimized:** If this checkbox is disabled the J-Link status window will show up automatically each time the DLL is loaded.
- **Always on top:** if this checkbox is enabled the J-Link status window is always visible even if other windows will be opened.

The general information about target hardware and J-Link which are shown in this section, are:

- **Process:** Shows the path of the file which loaded the DLL.
- **J-Link:** Shows OEM of the connected J-Link, the hardware version and the Serial number. If no J-Link is connected it shows "not connected" and the color indicator is red.
- **Target interface:** Shows the selected target interface (JTAG/SWD) and the current JTAG speed. The target current is also shown. (Only visible if J-Link is connected)
- **Endian:** Shows the target endianness (Only visible if J-Link is connected)
- **Device:** Shows the selected device for the current debug session.
- **License:** Opens the J-Link license manager.
- **About:** Opens the about dialog.

5.7.1.2 Settings

In the **Settings** section project- and debug-specific settings can be set. It allows the configuration of the use of flash download and flash breakpoints and some other target specific settings which will be explained in this topic. Settings are saved in the configuration file. This configuration file needs to be set by the debugger. If the debugger does not set it, settings can not be saved. All settings can only be changed by the user himself. All settings which are modified during the debug session have to be saved by pressing **Save settings**, otherwise they are lost when the debug session is closed.

Section: Flash download

In this section, settings for the use of the J-Link FlashDL feature and related settings can be configured. When a license for J-Link FlashDL is found, the color indicator is green and "License found" appears right to the J-Link FlashDL usage settings.

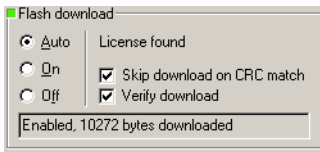

- **Auto:** This is the default setting of J-Link FlashDL usage. If a license is found J-Link FlashDL is enabled. Otherwise J-Link FlashDL will be disabled internally.
- **On:** Enables the J-Link FlashDL feature. If no license has been found an error message appears.
- **Off:** Disables the J-Link FlashDL feature.
- **Skip download on CRC match:** J-Link checks the CRC of the flash content to determine if the current application has already been downloaded to the flash. If a CRC match occurs, the flash download is not necessary and skipped. (Only available if J-Link FlashDL usage is configured as **Auto** or **On**)
- **Verify download:** If this checkbox is enabled J-Link verifies the flash content after the download. (Only available if J-Link FlashDL usage is configured as **Auto** or **On**)

Section: Flash breakpoints:

In this section, settings for the use of the FlashBP feature and related settings can be configured. When a license for FlashBP is found, the color indicator is green and "License found" appears right to the FlashBP usage settings.

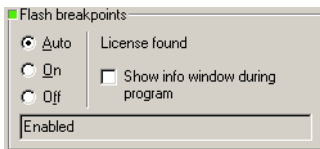

- **Auto:** This is the default setting of FlashBP usage. If a license has been found the FlashBP feature will be enabled. Otherwise FlashBP will be disabled internally.
- **On:** Enables the FlashBP feature. If no license has been found an error message appears.
- **Off:** Disables the FlashBP feature.
- **Show window during program:** When this checkbox is enabled the "Programming flash" window is shown when flash is re-programmed in order to set/clear flash breakpoints.

Flash download and flash breakpoints independent settings

These settings do not belong to the J-Link flash download and flash breakpoints settings section. They can be configured without any license needed.

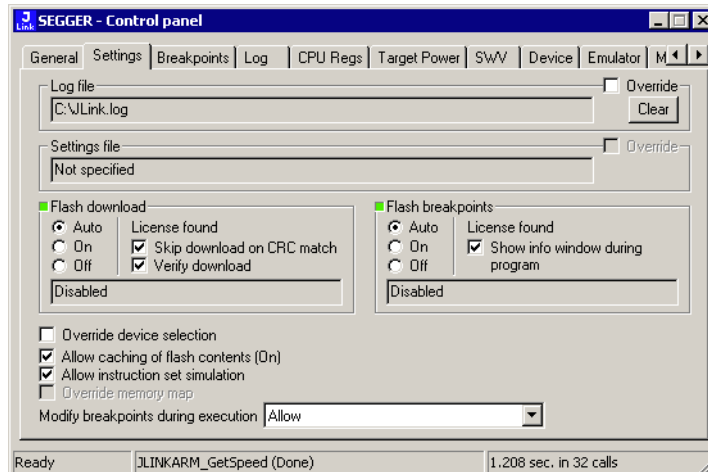

- **Log file:** Shows the path where the J-Link log file is placed. It is possible to override the selection manually by enabling the Override checkbox. If the Override checkbox is enabled a button appears which let the user choose the new location of the log file.
- **Settings file:** Shows the path where the configuration file is placed. This configuration file contains all the settings which can be configured in the **Settings** tab.
- **Override device selection:** If this checkbox is enabled, a dropdown list appears, which allows the user to set a device manually. This especially makes sense when J-Link can not identify the device name given by the debugger or if a particular device is not yet known to the debugger, but to the J-Link software.
- **Allow caching of flash contents:** If this checkbox is enabled, the flash contents are cached by J-Link to avoid reading data twice. This speeds up the transfer between debugger and target.
- **Allow instruction set simulation:** If this checkbox is enabled, instructions will be simulated as far as possible. This speeds up single stepping, especially when FlashBPs are used.
- **Save settings:** When this button is pushed, the current settings in the **Settings** tab will be saved in a configuration file. This file is created by J-Link and will be created for each project and each project configuration (e.g. Debug_RAM, Debug_Flash). If no settings file is given, this button is not visible.
- **Modify breakpoints during execution:** This dropdown box allows the user to change the behavior of the DLL when setting breakpoints if the CPU is running. The following options are available:
 - Allow:** Allows settings breakpoints while the CPU is running. If the CPU needs to be halted in order to set the breakpoint, the DLL halts the CPU, sets the breakpoints and restarts the CPU.
 - Allow if CPU does not need to be halted:** Allows setting breakpoints while the CPU is running, if it does not need to be halted in order to set the breakpoint. If the CPU has to be halted the breakpoint is not set.
 - Ask user if CPU needs to be halted:** If the user tries to set a breakpoint while the CPU is running and the CPU needs to be halted in order to set the breakpoint, the user is asked if the breakpoint should be set. If the breakpoint can be set without halting the CPU, the breakpoint is set without explicitly confirmation by the user.
 - Do not allow:** It is not allowed to set breakpoints while the CPU is running.

5.7.1.3 Break/Watch

In the Break/Watch section all breakpoints and watchpoints which are in the DLL internal breakpoint and watchpoint list are shown.

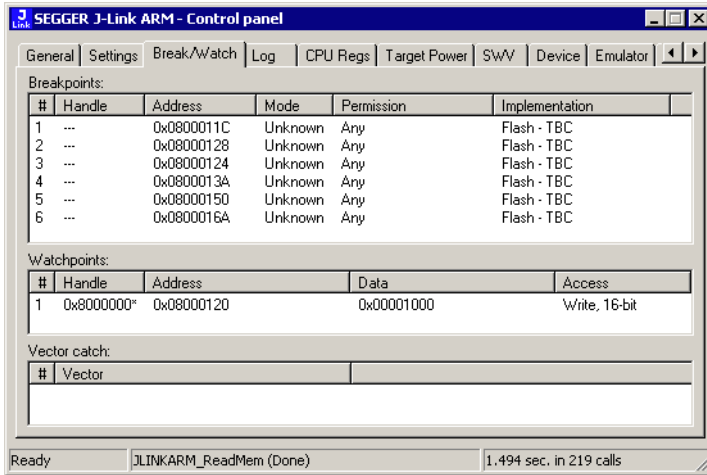

Section: Code

Lists all breakpoints which are in the DLL internal breakpoint list are shown.

- **Handle:** Shows the handle of the breakpoint.
- **Address:** Shows the address where the breakpoint is set.
- **Mode:** Describes the breakpoint type (ARM/THUMB)
- **Permission:** Describes the breakpoint implementation flags.
- **Implementation:** Describes the breakpoint implementation type. The breakpoint types are: RAM, Flash, Hard. An additional TBC (to be cleared) or TBS (to be set) gives information about if the breakpoint is (still) written to the target or if it's just in the breakpoint list to be written/cleared.

Note: It is possible for the debugger to bypass the breakpoint functionality of the J-Link software by writing to the debug registers directly. This means for ARM7/ARM9 cores write accesses to the ICE registers, for Cortex-M3 devices write accesses to the memory mapped flash breakpoint registers and in general simple write accesses for software breakpoints (if the program is located in RAM). In these cases, the J-Link software can not determine the breakpoints set and the list is empty.

Section: Data

In this section, all data breakpoints which are listed in the DLL internal breakpoint list are shown.

- **Handle:** Shows the handle of the data breakpoint.
- **Address:** Shows the address where the data breakpoint is set.
- **AddrMask:** Specifies which bits of **Address** are disregarded during the comparison for a data breakpoint match. (A 1 in the mask means: disregard this bit)
- **Data:** Shows on which data to be monitored at the address where the data breakpoint is set.
- **Data Mask:** Specifies which bits of **Data** are disregarded during the comparison for a data breakpoint match. (A 1 in the mask means: disregard this bit)
- **Ctrl:** Specifies the access type of the data breakpoint (read/write).
- **CtrlMask:** Specifies which bits of Ctrl are disregarded during the comparison for a data breakpoint match.

5.7.1.4 Log

In this section the log output of the DLL is shown. The user can determine which function calls should be shown in the log window.

Available function calls to log: Register read/write, Memory read/write, set/clear breakpoint, step, go, halt, is halted.

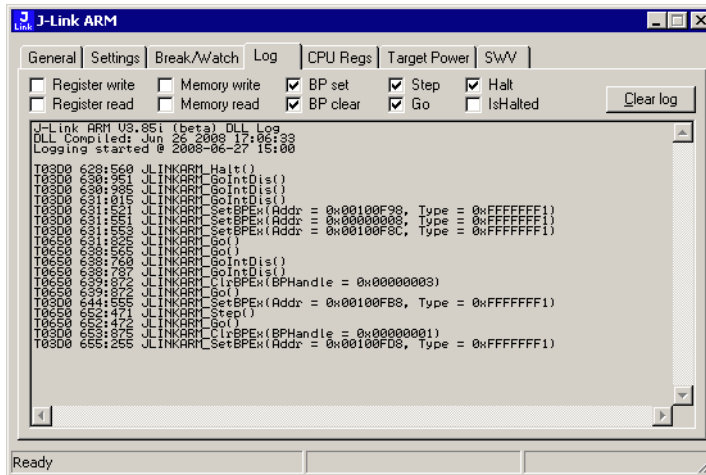

5.7.1.5 CPU Regs

In this section the name and the value of the CPU registers are shown.

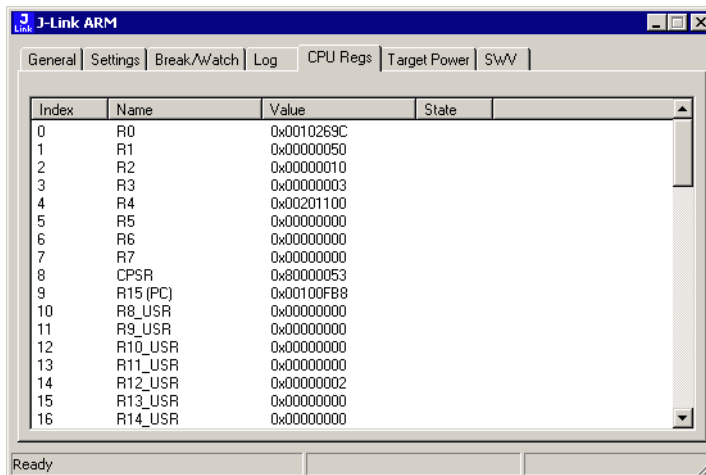

5.7.1.6 Target Power

In this section currently just the power consumption of the target hardware is shown.

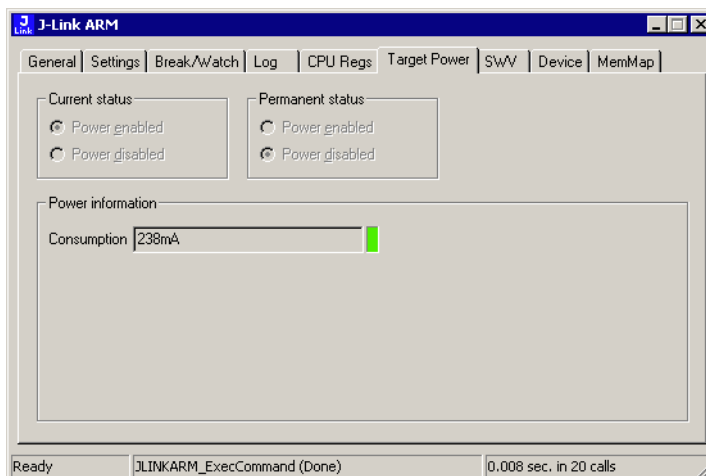

5.7.1.7 SWV

In this section SWV information are shown.

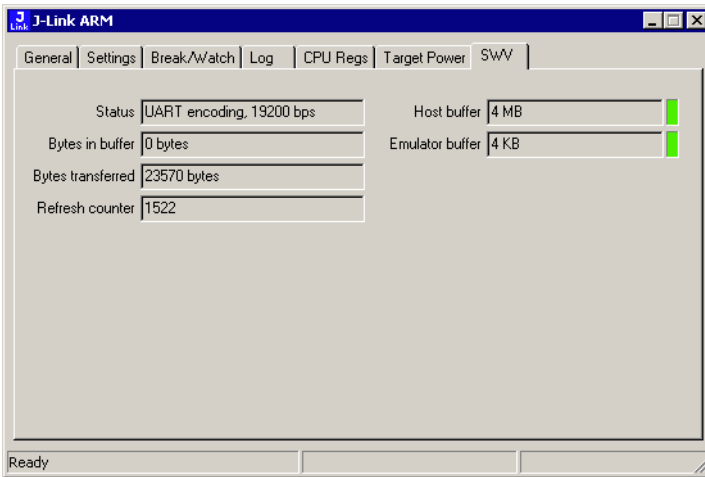

- **Status:** Shows the encoding and the baudrate of the SWV data received by the target (Manchester/UART, currently J-Link only supports UART encoding).
- **Bytes in buffer:** Shows how many bytes are in the DLL SWV data buffer.
- **Bytes transferred:** Shows how many bytes have been transferred via SWV, since the debug session has been started.
- **Refresh counter:** Shows how often the SWV information in this section has been updated since the debug session has been started.
- **Host buffer:** Shows the reserved buffer size for SWV data, on the host side.
- **Emulator buffer:** Shows the reserved buffer size for SWV data, on the emulator side.

5.8 Reset strategies

J-Link / J-Trace supports different reset strategies. This is necessary because there is no single way of resetting and halting an CPU core before it starts to execute instructions. For example reset strategies which use the reset pin can not succeed on targets where the reset pin of the CPU is not connected to the reset pin of the JTAG connector. Reset strategy 0 is always the recommended one because it has been adapted to work on every target even if the reset pin (Pin 15) is not connected.

What is the problem if the core executes some instructions after RESET?

The instructions which are executed can cause various problems. Some cores can be completely "confused", which means they can not be switched into debug mode (CPU can not be halted). In other cases, the CPU may already have initialized some hardware components, causing unexpected interrupts or worse, the hardware may have been initialized with illegal values. In some of these cases, such as illegal PLL settings, the CPU may be operated beyond specification, possibly locking the CPU.

5.8.1 Strategies for ARM 7/9 devices

5.8.1.1 Type 0: Hardware, halt after reset (normal)

The hardware reset pin is used to reset the CPU. After reset release, J-Link continuously tries to halt the CPU. This typically halts the CPU shortly after reset release; the CPU can in most systems execute some instructions before it is halted. The number of instructions executed depends primarily on the JTAG speed: the higher the JTAG speed, the faster the CPU can be halted.

Some CPUs can actually be halted before executing any instruction, because the start of the CPU is delayed after reset release. If a pause has been specified, J-Link waits for the specified time before trying to halt the CPU. This can be useful if a bootloader which resides in flash or ROM needs to be started after reset.

This reset strategy is typically used if nRESET and nTRST are coupled. If nRESET and nTRST are coupled, either on the board or the CPU itself, reset clears the breakpoint, which means that the CPU can not be stopped after reset with the BP@0 reset strategy.

5.8.1.2 Type 1: Hardware, halt with BP@0

The hardware reset pin is used to reset the CPU. Before doing so, the ICE breaker is programmed to halt program execution at address 0; effectively, a breakpoint is set at address 0. If this strategy works, the CPU is actually halted before executing a single instruction.

This reset strategy does not work on all systems for two reasons:

- If nRESET and nTRST are coupled, either on the board or the CPU itself, reset clears the breakpoint, which means the CPU is not stopped after reset.
- Some MCUs contain a bootloader program (sometimes called kernel), which needs to be executed to enable JTAG access.

5.8.1.3 Type 2: Software, for Analog Devices ADuC7xxx MCUs

This reset strategy is a software strategy. The CPU is halted and performs a sequence which causes a peripheral reset. The following sequence is executed:

- The CPU is halted
- A software reset sequence is downloaded to RAM
- A breakpoint at address 0 is set
- The software reset sequence is executed.

This sequence performs a reset of CPU and peripherals and halts the CPU before executing instructions of the user program. It is the recommended reset sequence for Analog Devices ADuC7xxx MCUs and works with these chips only.

5.8.1.4 Type 3: No reset

No reset is performed. Nothing happens.

5.8.1.5 Type 4: Hardware, halt with WP

The hardware RESET pin is used to reset the CPU. After reset release, J-Link continuously tries to halt the CPU using a watchpoint. This typically halts the CPU shortly after reset release; the CPU can in most systems execute some instructions before it is halted.

The number of instructions executed depends primarily on the JTAG speed: the higher the JTAG speed, the faster the CPU can be halted. Some CPUs can actually be halted before executing any instruction, because the start of the CPU is delayed after reset release

5.8.1.6 Type 5: Hardware, halt with DBGRQ

The hardware RESET pin is used to reset the CPU. After reset release, J-Link continuously tries to halt the CPU using the DBGRQ. This typically halts the CPU shortly after reset release; the CPU can in most systems execute some instructions before it is halted.

The number of instructions executed depends primarily on the JTAG speed: the higher the JTAG speed, the faster the CPU can be halted. Some CPUs can actually be halted before executing any instruction, because the start of the CPU is delayed after reset release.

5.8.1.7 Type 6: Software

This reset strategy is only a software reset. "Software reset" means basically no reset, just changing the CPU registers such as PC and CPSR. This reset strategy sets the CPU registers to their after-Reset values:

- PC = 0
- CPSR = 0xD3 (Supervisor mode, ARM, IRQ / FIQ disabled)
- All SPSR registers = 0x10
- All other registers (which are unpredictable after reset) are set to 0.
- The hardware RESET pin is not affected.

5.8.1.8 Type 7: Reserved

Reserved reset type.

5.8.1.9 Type 8: Software, for ATMEL AT91SAM7 MCUs

The reset pin of the device is disabled by default. This means that the reset strategies which rely on the reset pin (low pulse on reset) do not work by default. For this reason a special reset strategy has been made available.

It is recommended to use this reset strategy. This special reset strategy resets the peripherals by writing to the RSTC_CR register. Resetting the peripherals puts all peripherals in the defined reset state. This includes memory mapping register, which means that after reset flash is mapped to address 0. It is also possible to achieve the same effect by writing 0x4 to the RSTC_CR register located at address 0xffffd00.

5.8.1.10 Type 9: Hardware, for NXP LPC MCUs

After reset a bootloader is mapped at address 0 on ARM 7 LPC devices. This reset strategy performs a reset via reset strategy Type 1 in order to reset the CPU. It also ensures that flash is mapped to address 0 by writing the MEMMAP register of the LPC. This reset strategy is the recommended one for all ARM 7 LPC devices.

5.8.2 Strategies for Cortex-M devices

J-Link supports different specific reset strategies for the Cortex-M cores. All of the following reset strategies are available in JTAG and in SWD mode. All of them halt the CPU after the reset.

Note: It is recommended that the correct device is selected in the debugger so the debugger can pass the device name to the J-Link DLL which makes it possible for J-Link to detect what is the best reset strategy for the device. Moreover, we recommend that the debugger uses reset type 0 to allow J-Link to dynamically select what reset is the best for the connected device.

5.8.2.1 Type 0: Normal

This is the default strategy. It does whatever is the best way to reset the target device.

If the correct device is selected in the debugger this reset strategy may also perform some special handling which might be necessary for the connected device. This for example is the case for devices which have a ROM bootloader that needs to run after reset and before the user application is started (especially if the debug interface is disabled after reset and needs to be enabled by the ROM bootloader).

For most devices, this reset strategy does the same as reset strategy 8 does:

1. Make sure that the device halts immediately after reset (before it can execute any instruction of the user application) by setting the `VC_CORERESSET` in the `DEMCR`.
2. Reset the core and peripherals by setting the `SYSRESETREQ` bit in the `AIRCR`.
3. Wait for the `S_RESET_ST` bit in the `DHCSR` to first become high (reset active) and then low (reset no longer active) afterwards.
4. Clear `VC_CORERESSET`.

5.8.2.2 Type 1: Core

Only the core is reset via the `VECTRESET` bit. The peripherals are not affected. After setting the `VECTRESET` bit, J-Link waits for the `S_RESET_ST` bit in the Debug Halting Control and Status Register (`DHCSR`) to first become high and then low afterwards. The CPU does not start execution of the program because J-Link sets the `VC_CORERESSET` bit before reset, which causes the CPU to halt before execution of the first instruction.

Note: In most cases it is not recommended to reset the core only since most target applications rely on the reset state of some peripherals (PLL, External memory interface etc.) and may be confused if they boot up but the peripherals are already configured.

5.8.2.3 Type 2: ResetPin

J-Link pulls its `RESET` pin low to reset the core and the peripherals. This normally causes the CPU `RESET` pin of the target device to go low as well, resulting in a reset of both CPU and peripherals. This reset strategy will fail if the `RESET` pin of the target device is not pulled low. The CPU does not start execution of the program because J-Link sets the `VC_CORERESSET` bit before reset, which causes the CPU to halt before execution of the first instruction.

5.8.2.4 Type 3: Connect under Reset

J-Link connects to the target while keeping Reset active (reset is pulled low and remains low while connecting to the target). This is the recommended reset strategy for STM32 devices. This reset strategy has been designed for the case that communication with the core is not possible in normal mode so the `VC_CORERESSET` bit can not be set in order to guarantee that the core is halted immediately after reset.

5.8.2.5 Type 4: Reset core & peripherals, halt after bootloader

Same as type 0, but bootloader is always executed. This reset strategy has been designed for MCUs/CPUs which have a bootloader located in ROM which needs to run at first, after reset (since it might initialize some target settings to their reset state). When using this reset strategy, J-Link will let the bootloader run after reset and halts the target immediately after the bootloader and before the target application is started. This is the recommended reset strategy for LPC11xx and LPC13xx devices where a bootloader should execute after reset to put the chip into the "real" reset state.

5.8.2.6 Type 5: Reset core & peripherals, halt before bootloader

Basically the same as reset type 8. Performs a reset of core & peripherals and halts the CPU immediately after reset. The ROM bootloader is NOT executed.

5.8.2.7 Type 6: Reset for Freescale Kinetis devices

Performs a via reset strategy 0 (normal) first in order to reset the core & peripherals and halt the CPU immediately after reset. After the CPU is halted, the watchdog is disabled, since the watchdog is running after reset by default and if the target application does not feed the watchdog, J-Link loses connection to the device since it is reset permanently.

5.8.2.8 Type 7: Reset for Analog Devices CPUs (ADI Halt after kernel)

Performs a reset of the core and peripherals by setting the `SYSRESETREQ` bit in the `AIRCR`. The core is allowed to perform the ADI kernel (which enables the debug interface) but the core is halted before the first instruction after the kernel is executed in order to guarantee that no user application code is performed after reset.

Type 8: Reset core and peripherals

J-Link tries to reset both, core and peripherals by setting the `SYSRESETREQ` bit in the `AIRCR`. The `VC_CORERESSET` bit is used to halt the CPU before it executes a single instruction.

5.8.2.9 Type 8: Reset core and peripherals

Performs a reset by setting the `SYSRESETREQ` bit in the `AIRCR`. `VC_CORERESSET` in the `DEMCR` is also set to make sure that the CPU is halted immediately after reset and before executing any instruction.

Reset procedure:

1. Make sure that the device halts immediately after reset (before it can execute any instruction of the user application) by setting the `VC_CORERESSET` in the `DEMCR`.
2. Reset the core and peripherals by setting the `SYSRESETREQ` bit in the `AIRCR`.
3. Wait for the `S_RESET_ST` bit in the `DHCSR` to first become high (reset active) and then low (reset no longer active) afterwards.
4. Clear `VC_CORERESSET`.

This type of reset may fail if:

- J-Link has no connection to the debug interface of the CPU because it is in a low power mode.
- The debug interface is disabled after reset and needs to be enabled by a device internal bootloader. This would cause J-Link to lose communication after reset since the CPU is halted before it can execute the internal bootlader.

5.8.2.10 Type 9: Reset for LPC1200 devices

On the NXP LPC1200 devices the watchdog is enabled after reset and not disabled by the bootloader, if a valid application is in the flash memory. Moreover, the watchdog keeps counting if the CPU is in debug mode. When using this reset strategy, J-Link

performs a reset of the CPU and peripherals, using the `SYSRESETREQ` bit in the `AIRCR` and halts the CPU after the bootloader has been performed and before the first instruction of the user code is executed. Then the watchdog of the LPC1200 device is disabled. This reset strategy is only guaranteed to work on "modern" J-Links (J-Link V8, J-Link Pro, J-link ULTRA, J-Trace for Cortex-M, J-Link Lite) and if a SWD speed of min. 1 MHz is used. This reset strategy should also work for J-Links with hardware version 6, but it can not be guaranteed that these J-Links are always fast enough in disabling the watchdog.

5.8.2.11 Type 10: Reset for Samsung S3FN60D devices

On the Samsung S3FN60D devices the watchdog may be running after reset (if the watchdog is active after reset or not depends on content of the smart option bytes at addr 0xC0). The watchdog keeps counting even if the CPU is in debug mode (e.g. halted by a halt request or halted by vector catch). When using this reset strategy, J-Link performs a reset of the CPU and peripherals, using the `SYSRESETREQ` bit and sets `VC_CORERESET` in order to halt the CPU after reset, before it executes a single instruction. Then the watchdog of the S3FN60D device is disabled.

5.9 Using DCC for memory access

The ARM7/9 architecture requires cooperation of the CPU to access memory when the CPU is running (not in debug mode). This means that memory can not normally be accessed while the CPU is executing the application program. The normal way to read or write memory is to halt the CPU (put it into debug mode) before accessing memory. Even if the CPU is restarted after the memory access, the real time behavior is significantly affected; halting and restarting the CPU costs typically multiple milliseconds. For this reason, most debuggers do not even allow memory access if the CPU is running.

Fortunately, there is one other option: DCC (Direct communication channel) can be used to communicate with the CPU while it is executing the application program. All that is required is that the application program calls a DCC handler from time to time. This DCC handler typically requires less than 1 μ s per call.

The DCC handler, as well as the optional DCC abort handler, is part of the J-Link software package and can be found in the `Samples\DCC\IAR` directory of the package.

5.9.1 What is required?

- An application program on the host (typically a debugger) that uses DCC
- A target application program that regularly calls the DCC handler
- The supplied abort handler should be installed (optional)

An application program that uses DCC is `JLink.exe`.

5.9.2 Target DCC handler

The target DCC handler is a simple C-file taking care of the communication. The function `DCC_Process()` needs to be called regularly from the application program or from an interrupt handler. If a RTOS is used, a good place to call the DCC handler is from the timer tick interrupt. In general, the more often the DCC handler is called, the faster memory can be accessed. On most devices, it is also possible to let the DCC generate an interrupt which can be used to call the DCC handler.

5.9.3 Target DCC abort handler

An optional DCC abort handler (a simple assembly file) can be included in the application. The DCC abort handler allows data aborts caused by memory reads/writes via DCC to be handled gracefully. If the data abort has been caused by the DCC communication, it returns to the instruction right after the one causing the abort, allowing the application program to continue to run. In addition to that, it allows the host to detect if a data abort occurred.

In order to use the DCC abort handler, 3 things need to be done:

- Place a branch to `DCC_Abort` at address `0x10` ("vector" used for data aborts)
- Initialize the Abort-mode stack pointer to an area of at least 8 bytes of stack memory required by the handler
- Add the DCC abort handler assembly file to the application

5.10 J-Link script files

In some situations it is necessary to customize some actions performed by J-Link. In most cases it is the connection sequence and/or the way in which a reset is performed by J-Link, since some custom hardware needs some special handling which can not be integrated into the generic part of the J-Link software. J-Link script files are written in C-like syntax in order to have an easy start to learning how to write J-Link script files. The script file syntax does support most statements (if-else, while, declaration of variables, ...) which are allowed in C, but not all of them. Moreover, there are some statements that are script file specific. The script file allows maximum flexibility, so almost any target initialization which is necessary, can be supported.

5.10.1 Actions that can be customized

The script file support allows customizing of different actions performed by J-Link. If a generic-implemented action is replaced by an action defined in a script file depends on if the corresponding function is present in the script file. In the following all J-Link actions which can be customized using a script file, are listed and explained.

5.10.1.1 ResetTarget()

Description

If present, it replaces the reset strategy performed by the DLL when issuing a reset.

Prototype

```
void ResetTarget(void);
```

5.10.1.2 InitEMU()

Description

If present, it allows configuration of the emulator prior to starting target communication. Currently this function is only used to configure if the target which is connected to J-Link has an ETB or not. For more information how to configure the existence of an ETB, please refer to *Global DLL variables* on page 169.

Prototype

```
void InitEMU(void);
```

5.10.1.3 InitTarget()

Description

If present, it can replace the auto-detection capability of J-Link. Some targets can not be auto-detected by J-Link since some special target initialization is necessary before communication with the core is possible. Moreover, J-Link uses a TAP reset to get the JTAG IDs of the devices in the JTAG chain. On some targets this disables access to the core.

Prototype

```
void InitTarget(void);
```

5.10.2 Script file API functions

In the following, the API functions which can be used in a script file to communicate with the DLL are explained.

5.10.2.1 MessageBox()

Description

Outputs a string in a message box.

Prototype

```
__api__ int MessageBox(const char * sMsg);
```

5.10.2.2 MessageBox1()

Description

Outputs a constant character string in a message box. In addition to that, a given value (can be a constant value, the return value of a function or a variable) is added, right behind the string.

Prototype

```
__api__ int MessageBox1(const char * sMsg, int v);
```

5.10.2.3 Report()

Description

Outputs a constant character string on stdio.

Prototype

```
__api__ int Report(const char * sMsg);
```

5.10.2.4 Report1()

Description

Outputs a constant character string on stdio. In addition to that, a given value (can be a constant value, the return value of a function or a variable) is added, right behind the string.

Prototype

```
__api__ int Report1(const char * sMsg, int v);
```

5.10.2.5 JTAG_SetDeviceId()

Description

Sets the JTAG Id of a specified device, in the JTAG chain. The index of the device depends on its position in the JTAG chain. The device closest to TDO has index 0. The Id is used by the DLL to recognize the device.

Before calling this function, please make sure that the JTAG chain has been configured correctly by setting the appropriate global DLL variables. For more information about the known global DLL variables, please refer to *Global DLL variables* on page 169.

Prototype

```
__api__ int JTAG_SetDeviceId(int DeviceIndex, unsigned int Id);
```

5.10.2.6 JTAG_GetDeviceId()

Description

Retrieves the JTAG Id of a specified device, in the JTAG chain. The index of the device depends on its position in the JTAG chain. The device closest to TDO has index 0.

Prototype

```
__api__ int JTAG_GetDeviceId(int DeviceIndex);
```

5.10.2.7 JTAG_WriteIR()

Description

Writes a JTAG instruction.

Before calling this function, please make sure that the JTAG chain has been configured correctly by setting the appropriate global DLL variables. For more information about the known global DLL variables, please refer to *Global DLL variables* on page 169.

Prototype

```
__api__ int JTAG_WriteIR(unsigned int Cmd);
```

5.10.2.8 JTAG_StoreIR()

Description

Stores a JTAG instruction in the DLL JTAG buffer.

Before calling this function, please make sure that the JTAG chain has been configured correctly by setting the appropriate global DLL variables. For more information about the known global DLL variables, please refer to *Global DLL variables* on page 169.

Prototype

```
__api__ int JTAG_StoreIR(unsigned int Cmd);
```

5.10.2.9 JTAG_WriteDR()

Description

Writes JTAG data.

Before calling this function, please make sure that the JTAG chain has been configured correctly by setting the appropriate global DLL variables. For more information about the known global DLL variables, please refer to *Global DLL variables* on page 169.

Prototype

```
__api__ int JTAG_WriteDR(unsigned __int64 tdi, int NumBits);
```

5.10.2.10 JTAG_StoreDR()

Description

Stores JTAG data in the DLL JTAG buffer.

Before calling this function, please make sure that the JTAG chain has been configured correctly by setting the appropriate global DLL variables. For more information about the known global DLL variables, please refer to *Global DLL variables* on page 169.

Prototype

```
__api__ int JTAG_StoreDR(unsigned __int64 tdi, int NumBits);
```

5.10.2.11 JTAG_Write()

Description

Writes a JTAG sequence (max. 64 bits per pin).

Prototype

```
__api__ int JTAG_Write(unsigned __int64 tms, unsigned __int64 tdi, int NumBits);
```

5.10.2.12 JTAG_Store()

Description

Stores a JTAG sequence (max. 64 bits per pin) in the DLL JTAG buffer.

Prototype

```
__api__ int JTAG_Store(unsigned __int64 tms, unsigned __int64 tdi, int NumBits);
```

5.10.2.13 JTAG_GetU32()

Description

Gets 32 bits JTAG data, starting at given bit position.

Prototype

```
__api__ int JTAG_GetU32(int BitPos);
```

5.10.2.14 JTAG_WriteClocks()

Description

Writes a given number of clocks.

Prototype

```
__api__ int JTAG_WriteClocks(int NumClocks);
```

5.10.2.15 JTAG_StoreClocks()

Description

Stores a given number of clocks in the DLL JTAG buffer.

Prototype

```
__api__ int JTAG_StoreClocks(int NumClocks);
```

5.10.2.16 JTAG_Reset()

Description

Performs a TAP reset and tries to auto-detect the JTAG chain (Total IRLen, Number of devices). If auto-detection was successful, the global DLL variables which determine the JTAG chain configuration, are set to the correct values. For more information about the known global DLL variables, please refer to *Global DLL variables* on page 169.

Note: This will not work for devices which need some special init (for example to add the core to the JTAG chain), which is lost at a TAP reset.

Prototype

```
__api__ int JTAG_Reset(void);
```

5.10.2.17 SYS_Sleep()

Description

Waits for a given number of milliseconds. During this time, J-Link does not communicate with the target.

Prototype

```
__api__ int SYS_Sleep(int Delays);
```

5.10.2.18 CORESIGHT_AddAP()

Description

Allows the user to manually configure the AP-layout of the device J-Link is connected to. This makes sense on targets where J-Link can not perform a auto-detection of the APs which are present of the target system. Type can only be a known global J-Link DLL AP constant. For a list of all available constants, please refer to *Global DLL constants* on page 172.

Prototype

```
__api__ int CORESIGHT_AddAP(int Index, unsigned int Type);
```

Example

```
CORESIGHT_AddAP(0, CORESIGHT_AHB_AP); // First AP is a AHB-AP
CORESIGHT_AddAP(1, CORESIGHT_APB_AP); // Second AP is a APB-AP
CORESIGHT_AddAP(2, CORESIGHT_JTAG_AP); // Third AP is a JTAG-AP
```

5.10.3 Global DLL variables

The script file feature also provides some global variables which are used for DLL configuration. Some of these variables can only be set to some specific values, other ones can be set to the whole datatype with. In the following all global variables and their value ranges are listed and described.

Note: All global variables are treated as unsigned 32-bit values and are zero-initialized.

Variable	Description	R/W
CPU	Pre-select target CPU J-Link is communicating with. Used in InitTarget() to skip the core auto-detection of J-Link. This variable can only be set to a known global J-Link DLL constant. For a list of all valid values, please refer to <i>Global DLL constants</i> on page 172. Example CPU = ARM926EJS;	W
JTAG_IRPre	Used for JTAG chain configuration. Sets the number of IR-bits of all devices which are closer to TDO than the one we want to communicate with. Example JTAG_IRPre = 6;	R/W
JTAG_DRPre	Used for JTAG chain configuration. Sets the number of devices which are closer to TDO than the one we want to communicate with. Example JTAG_DRPre = 2;	R
JTAG_IRPost	Used for JTAG chain configuration. Sets the number of IR-bits of all devices which are closer to TDI than the one we want to communicate with. Example JTAG_IRPost = 6;	R
JTAG_DRPost	Used for JTAG chain configuration. Sets the number of devices which are closer to TDI than the one we want to "communicate with". Example JTAG_DRPost = 0;	R

Table 5.10: Global DLL variables

Variable	Description	R/W
JTAG_IRLen	IR-Len (in bits) of the device we want to communicate with. Example JTAG_IRLen = 4;	R
JTAG_TotalIRLen	Computed automatically, based on the values of JTAG_IRPre, JTAG_DRPre, JTAG_IRPost and JTAG_DRPost. Example v = JTAG_TotalIRLen;	R
JTAG_AllowTAPReset	En-/Disables auto-JTAG-detection of J-Link. Has to be disabled for devices which need some special init (for example to add the core to the JTAG chain), which is lost at a TAP reset. Allowed values 0 Auto-detection is enabled. 1 Auto-detection is disabled.	W
JTAG_Speed	Sets the JTAG interface speed. Speed is given in kHz. Example JTAG_Speed = 2000; // 2MHz JTAG speed	W
JTAG_ResetPin	Pulls reset pin low / Releases nRST pin. Used to issue a reset of the CPU. Value assigned to reset pin reflects the state. 0 = Low, 1 = high. Example JTAG_ResetPin = 0; SYS_Sleep(5); // Give pin some time to get low JTAG_ResetPin = 1;	W
JTAG_TRSTPin	Pulls reset pin low / Releases nTRST pin. Used to issue a reset of the debug logic of the CPU. Value assigned to reset pin reflects the state. 0 = Low, 1 = high. Example JTAG_TRSTPin = 0; SYS_Sleep(5); // Give pin some time to get low JTAG_TRSTPin = 1;	W
JTAG_TCKPin	Pulls TCK pin LOW / HIGH. Value assigned to reset pin reflects the state. 0 = LOW, 1 = HIGH. Example JTAG_TCKPin = 0;	R/W
JTAG_TDIpin	Pulls TDI pin LOW / HIGH. Value assigned to reset pin reflects the state. 0 = LOW, 1 = HIGH. Example JTAG_TDIpin = 0;	R/W
JTAG_TMSpin	Pulls TMS pin LOW / HIGH. Value assigned to reset pin reflects the state. 0 = LOW, 1 = HIGH. Example JTAG_TMSpin = 0;	R/W
EMU_ETB_IsPresent	If the connected device has an ETB and you want to use it with J-link, this variable should be set to 1. Setting this variable in another function as InitEmu() does not have any effect. Example void InitEmu(void) { EMU_ETB_IsPresent = 1; }	W

Table 5.10: Global DLL variables

Variable	Description	R/W
<code>EMU_ETB_UseETB</code>	Use ETB instead of RAWTRACE capability of the emulator. Setting this variable in another function as <code>InitEmu()</code> does not have any effect. Example <code>EMU_ETB_UseETB = 0;</code>	R
<code>EMU_ETM_IsPresent</code>	Selects whether an ETM is present on the target or not. Setting this variable in another function as <code>InitEmu()</code> does not have any effect. Example <code>EMU_ETM_IsPresent= 0;</code>	R/W
<code>EMU_ETM_UseETM</code>	Use ETM as trace source. Setting this variable in another function as <code>InitEmu()</code> does not have any effect. Example <code>EMU_ETM_UseETM = 1;</code>	W
<code>EMU_JTAG_DisableHWTransmissions</code>	Disable use of hardware units for JTAG transmissions since this can cause problems on some hardware designs. Example <code>EMU_JTAG_DisableHWTransmissions = 1;</code>	W
<code>CORESIGHT_CoreBaseAddr</code>	Set base address of core debug component for CoreSight compliant devices. Setting this variable disables the J-Link auto-detection of the core debug component base address. Used on devices where auto-detection of the core debug component base address is not possible due to incorrect CoreSight information. Example <code>CORESIGHT_CoreBaseAddr = 0x80030000;</code>	R/W
<code>CORESIGHT_IndexAHBAPToUse</code>	Pre-select an AP as an AHB-AP that J-Link uses for debug communication (Cortex-M). Setting this variable is necessary for example when debugging multi-core devices where multiple AHB-APs are present (one for each device). This function can only be used if a AP-layout has been configured via <code>CORESIGHT_AddAP()</code> . Example <code>CORESIGHT_AddAP(0, CORESIGHT_AHB_AP);</code> <code>CORESIGHT_AddAP(1, CORESIGHT_AHB_AP);</code> <code>CORESIGHT_AddAP(2, CORESIGHT_APB_AP);</code> <code>//</code> <code>// Use second AP as AHB-AP</code> <code>// for target communication</code> <code>//</code> <code>CORESIGHT_IndexAHBAPToUse = 1;</code>	W

Table 5.10: Global DLL variables

Variable	Description	R/W
<code>CORESIGHT_IndexAPBAPToUse</code>	<p>Pre-select an AP as an APB-AP that J-Link uses for debug communication (Cortex-A/R). Setting this variable is necessary for example when debugging multi-core devices where multiple APB-APs are present (one for each device). This function can only be used if a AP-layout has been configured via <code>CORESIGHT_AddAP()</code>.</p> <p>Example</p> <pre>CORESIGHT_AddAP(0, CORESIGHT_AHB_AP); CORESIGHT_AddAP(1, CORESIGHT_APB_AP); CORESIGHT_AddAP(2, CORESIGHT_APB_AP); // // Use third AP as APB-AP // for target communication // CORESIGHT_IndexAPBAPToUse = 2;</pre>	W
<code>MAIN_ResetType</code>	<p>Used to determine what reset type is currently selected by the debugger. This is useful, if the script has to behave differently if a specific reset type is selected by the debugger and the script file has a <code>ResetTarget()</code> function which overrides the J-Link reset strategies.</p> <p>Example</p> <pre>if (MAIN_ResetType == 2) { [...] } else { [...] }</pre>	R
<code>MAIN_IsFirstIdentify</code>	<p>Used to check if this is the first time we are running into <code>InitTarget()</code>. Useful if some init steps only need to be executed once per debug session.Example</p> <pre>if (MAIN_IsFirstIdentify == 1) { [...] } else { [...] }</pre>	R

Table 5.10: Global DLL variables

5.10.4 Global DLL constants

Currently there are only global DLL constants to set the global DLL variable `CPU`. If necessary, more constants will be implemented in the future.

5.10.4.1 Constants for global variable: CPU

The following constants can be used to set the global DLL variable `CPU`:

- ARM7
- ARM7TDMI
- ARM7TDMIR3
- ARM7TDMIR4
- ARM7TDMIS
- ARM7TDMISR3
- ARM7TDMISR4
- ARM9
- ARM9TDMIS
- ARM920T
- ARM922T
- ARM926EJS
- ARM946EJS

- ARM966ES
- ARM968ES
- ARM11
- ARM1136
- ARM1136J
- ARM1136JS
- ARM1136JF
- ARM1136JFS
- ARM1156
- ARM1176
- ARM1176J
- ARM1176JS
- ARM1176IF
- ARM1176JFS
- CORTEX_M0
- CORTEX_M1
- CORTEX_M3
- CORTEX_M3R1P0
- CORTEX_M3R1P1
- CORTEX_M3R2P0
- CORTEX_M4
- CORTEX_A5
- CORTEX_A8
- CORTEX_A9
- CORTEX_R4
- CORESIGHT_AHB_AP
- CORESIGHT_APB_AP
- CORESIGHT_JTAG_AP
- CORESIGHT_CUSTOM_AP

5.10.5 Script file language

The syntax of the J-Link script file language follows the conventions of the C-language, but it does not support all expressions and operators which are supported by the C-language. In the following, the supported operators and expressions are listed.

5.10.5.1 Supported Operators

The following operators are supported by the J-Link script file language:

- Multiplicative operators: *, /, %
- Additive operators: +, -
- Bitwise shift operators: <<, >>)
- Relational operators: <, >, <=, >=
- Equality operators: ==, !=
- Bitwise operators: &, |, ^
- Logical operators: &&, ||
- Assignment operators: =, *=, /=, +=, -=, <<=, >>=, &=, ^=, |=

5.10.5.2 Supported type specifiers

The following type specifiers are supported by the J-Link script file language:

- void
- char
- int (32-bit)
- __int64

5.10.5.3 Supported type qualifiers

The following type qualifiers are supported by the J-Link script file language:

- const
- signed

- unsigned

5.10.5.4 Supported declarators

The following type qualifiers are supported by the J-Link script file language:

- Array declarators

5.10.5.5 Supported selection statements

The following selection statements are supported by the J-Link script file language:

- if-statements
- if-else-statements

5.10.5.6 Supported iteration statements

The following iteration statements are supported by the J-Link script file language:

- while
- do-while

5.10.5.7 Jump statements

The following jump statements are supported by the J-Link script file language:

- return

5.10.5.8 Sample script files

The J-Link software and documentation package comes with sample script files for different devices. The sample script files can be found at `$JLINK_INST_DIR$\Samples\JLink\Scripts`.

5.10.6 Script file writing example

In the following, a short example how a J-Link script file could look like. In this example we assume a JTAG chain with two devices on it (Cortex-A8 4 bits IRLen, custom device 5-bits IRLen).

```
void InitTarget(void) {
    Report("J-Link script example.");
    JTAG_Reset(); // Perform TAP reset and J-Link JTAG auto-detection
    if (JTAG_TotalIRLen != 9) { // Basic check if JTAG chain information matches
        MessageBox("Can not find xxx device");
        return 1;
    }
    JTAG_DRPre = 0; // Cortex-A8 is closest to TDO, no no pre devices
    JTAG_DRPost = 1; // 1 device (custom device) comes after the Cortex-A8
    JTAG_IRPre = 0; // Cortex-A8 is closest to TDO, no no pre IR bits
    JTAG_IRPost = 5; // custom device after Cortex-A8 has 5 bits IR len
    JTAG_IRLen = 4; // We selected the Cortex-A8, it has 4 bits IRLen
    CPU = CORTEX_A8; // We are connected to a Cortex-A8
    JTAG_AllowTAPReset = 1; // We are allowed to enter JTAG TAP reset
    //
    // We have a non-CoreSight compliant Cortex-A8 here
    // which does not allow auto-detection of the Core debug components base address.
    // so set it manually to overwrite the DLL auto-detection
    //
    CORESIGHT_CoreBaseAddr = 0x80030000;
}
```

5.10.7 Executing J-Link script files

5.10.7.1 In J-Link commander

When J-Link commander is started it searches for a script file called `Default.JLinkScript` in the folder which contains the `JLink.exe` and the J-Link DLL (by default the installation folder e.g. `"C:\Program Files\SEGGER\JLinkARM_V456\"`).

If this file is found, it is executed instead of the standard auto detection of J-Link. If this file is not present, J-Link commander behaves as before and the normal auto-detection is performed.

5.10.7.2 In debugger IDE environment

To execute a script file out of your debugger IDE, simply select the script file to execute in the Settings tab of the J-Link control panel and click the save button (after the debug session has been started). Usually a project file for J-Link is set by the debugger, which allows the J-Link DLL to save the settings of the control panel in this project file. After selecting the script file restart your debug session. From now on, the script file will be executed when starting the debug session.

5.10.7.3 In GDB Server

In order to execute a script file when using J-Link GDB Server, simply start the GDB Server, using the following command line parameter:

```
-scriptfile <file>
```

For more information about the `-scriptfile` command line parameter, please refer to *J-Link GDB Server* on page 66.

5.11 Command strings

The behavior of the J-Link can be customized via command strings passed to the `JLinkARM.dll` which controls J-Link. Applications such as the J-Link Commander, but also the C-SPY debugger which is part of the IAR Embedded Workbench, allow passing one or more command strings. Command line strings can be used for passing commands to J-Link (such as switching on target power supply), as well as customize the behavior (by defining memory regions and other things) of J-Link. The use of command strings enables options which can not be set with the configuration dialog box provided by C-SPY.

5.11.1 List of available commands

The table below lists and describes the available command strings.

Command	Description
<code>device</code>	Selects the target device.
<code>DisableFlashBPs</code>	Disables the <code>FlashPB</code> feature.
<code>EnableFlashBPs</code>	Enables the <code>FlashPB</code> feature.
<code>map exclude</code>	Ignore all memory accesses to specified area.
<code>map indirectread</code>	Specifies an area which should be read indirect.
<code>map ram</code>	Specifies location of target RAM.
<code>map reset</code>	Restores the default mapping, which means all memory accesses are permitted.
<code>SetAllowSimulation</code>	Enable/Disable instruction set simulation.
<code>SetCheckModeAfterRead</code>	Enable/Disable CPSR check after read operations.
<code>SetResetPulseLen</code>	Defines the length of the RESET pulse in milliseconds.
<code>SetResetType</code>	Selects the reset strategy
<code>SetRestartOnClose</code>	Specifies restart behavior on close.
<code>SetDbgPowerDownOnClose</code>	Used to power-down the debug unit of the target CPU when the debug session is closed.
<code>SetSysPowerDownOnIdle</code>	Used to power-down the target CPU, when there are no transmissions between J-Link and target CPU, for a specified timeframe.
<code>SupplyPower</code>	Activates/Deactivates power supply over pin 19 of the JTAG connector.
<code>SupplyPowerDefault</code>	Activates/Deactivates power supply over pin 19 of the JTAG connector permanently.

Table 5.11: Available command line options

5.11.1.1 device

This command selects the target device.

Syntax

```
device = <DeviceID>
```

DeviceID has to be a valid device identifier. For a list of all available device identifiers please refer to chapter *Supported devices* on page 190.

Example

```
device = AT91SAM7S256
```

5.11.1.2 DisableFlashBPs

This command disables the FlashBP feature.

Syntax

```
DisableFlashBPs
```

5.11.1.3 EnableFlashBPs

This command enables the FlashBP feature.

Syntax

```
EnableFlashBPs
```

5.11.1.4 map exclude

This command excludes a specified memory region from all memory accesses. All subsequent memory accesses to this memory region are ignored.

Memory mapping

Some devices do not allow access of the entire 4GB memory area. Ideally, the entire memory can be accessed; if a memory access fails, the CPU reports this by switching to abort mode. The CPU memory interface allows halting the CPU via a WAIT signal. On some devices, the WAIT signal stays active when accessing certain unused memory areas. This halts the CPU indefinitely (until RESET) and will therefore end the debug session. This is exactly what happens when accessing critical memory areas. Critical memory areas should not be present in a device; they are typically a hardware design problem. Nevertheless, critical memory areas exist on some devices.

To avoid stalling the debug session, a critical memory area can be excluded from access: J-Link will not try to read or write to critical memory areas and instead ignore the access silently. Some debuggers (such as IAR C-SPY) can try to access memory in such areas by dereferencing non-initialized pointers even if the debugged program (the debuggee) is working perfectly. In situations like this, defining critical memory areas is a good solution.

Syntax

```
map exclude <SAddr>--<EAddr>
```

Example

This is an example for the `map exclude` command in combination with an NXP LPC2148 MCU.

Memory map

0x00000000-0x0007FFFF	On-chip flash memory
0x00080000-0x3FFFFFFF	Reserved
0x40000000-0x40007FFF	On-chip SRAM

0x40008000-0x7FCFFFFFFF	Reserved
0x7FD00000-0x7FD01FFF	On-chip USB DMA RAM
0x7FD02000-0x7FD02000	Reserved
0x7FFFD000-0x7FFFFFFF	Boot block (remapped from on-chip flash memory)
0x80000000-0xDFFFFFFF	Reserved
0xE0000000-0xEFFFFFFF	VPB peripherals
0xF0000000-0xFFFFFFFF	AHB peripherals

The "problematic" memory areas are:

0x00080000-0x3FFFFFFF	Reserved
0x40008000-0x7FCFFFFFFF	Reserved
0x7FD02000-0x7FD02000	Reserved
0x80000000-0xDFFFFFFF	Reserved

To exclude these areas from being accessed through J-Link the `map exclude` command should be used as follows:

```
map exclude 0x00080000-0x3FFFFFFF
map exclude 0x40008000-0x7FCFFFFFFF
map exclude 0x7FD02000-0x7FD02000
map exclude 0x80000000-0xDFFFFFFF
```

5.11.1.5 map indirectread

This command can be used to read a memory area indirectly. Indirectly reading means that a small code snippet is downloaded into RAM of the target device, which reads and transfers the data of the specified memory area to the host. Before `map indirectread` can be called a RAM area for the indirectly read code snippet has to be defined. Use therefor the `map ram` command and define a RAM area with a size of ≥ 256 byte.

Typical applications

Refer to chapter *Fast GPIO bug* on page 258 for an example.

Syntax

```
map indirectread <StartAddressOfArea>--<EndAddress>
```

Example

```
map indirectread 0x3fffc000-0x3fffcfff
```

5.11.1.6 map ram

This command should be used to define an area in RAM of the target device. The area must be 256-byte aligned. The data which was located in the defined area will not be corrupted. Data which resides in the defined RAM area is saved and will be restored if necessary. This command has to be executed before `map indirectread` will be called.

Typical applications

Refer to chapter *Fast GPIO bug* on page 258 for an example.

Syntax

```
map ram <StartAddressOfArea>--<EndAddressOfArea>
```

Example

```
map ram 0x40000000-0x40003fff;
```

5.11.1.7 map reset

This command restores the default memory mapping, which means all memory accesses are permitted.

Typical applications

Used with other "map" commands to return to the default values. The map reset command should be called before any other "map" command is called.

Syntax

```
map reset
```

Example

```
map reset
```

5.11.1.8 SetAllowSimulation

This command can be used to enable or disable the instruction set simulation. By default the instruction set simulation is enabled.

Syntax

```
SetAllowSimulation = 0 | 1
```

Example

```
SetAllowSimulation 1 // Enables instruction set simulation
```

5.11.1.9 SetCheckModeAfterRead

This command is used to enable or disable the verification of the CPSR (current processor status register) after each read operation. By default this check is enabled. However this can cause problems with some CPUs (e.g. if invalid CPSR values are returned). Please note that if this check is turned off (SetCheckModeAfterRead = 0), the success of read operations cannot be verified anymore and possible data aborts are not recognized.

Typical applications

This verification of the CPSR can cause problems with some CPUs (e.g. if invalid CPSR values are returned). Note that if this check is turned off (SetCheckModeAfterRead = 0), the success of read operations cannot be verified anymore and possible data aborts are not recognized.

Syntax

```
SetCheckModeAfterRead = 0 | 1
```

Example

```
SetCheckModeAfterRead = 0
```

5.11.1.10 SetResetPulseLen

This command defines the length of the RESET pulse in milliseconds. The default for the RESET pulse length is 20 milliseconds.

Syntax

```
SetResetPulseLen = <value>
```

Example

```
SetResetPulseLen = 50
```

5.11.1.11 SetResetType

This command selects the reset strategy which shall be used by J-Link, to reset the device. The value which is used for this command is analog to the reset type which shall be selected. For a list of all reset types which are available, please refer to *Reset strategies* on page 159. Please note that there are different reset strategies for ARM 7/9 and Cortex-M devices.

Syntax

```
SetResetType = <value>
```

Example

```
SetResetType = 0 // Selects reset strategy type 0: normal
```

5.11.1.12 SetRestartOnClose

This command specifies whether the J-Link restarts target execution on close. The default is to restart target execution. This can be disabled by using this command.

Syntax

```
SetRestartOnClose = 0 | 1
```

Example

```
SetRestartOnClose = 1
```

5.11.1.13 SetDbgPowerDownOnClose

When using this command, the debug unit of the target CPU is powered-down when the debug session is closed.

Note: This command works only for Cortex-M3 devices

Typical applications

This feature is useful to reduce the power consumption of the CPU when no debug session is active.

Syntax

```
SetDbgPowerDownOnClose = <value>
```

Example

```
SetDbgPowerDownOnClose = 1 // Enables debug power-down on close.  
SetDbgPowerDownOnClose = 0 // Disables debug power-down on close.
```

5.11.1.14 SetSysPowerDownOnIdle

When using this command, the target CPU is powered-down when no transmission between J-Link and the target CPU was performed for a specific time. When the next command is given, the CPU is powered-up.

Note: This command works only for Cortex-M3 devices.

Typical applications

This feature is useful to reduce the power consumption of the CPU.

Syntax

```
SetSysPowerDownOnIdle = <value>
```

Note: A 0 for <value> disables the power-down on idle functionality.

Example

```
SetSysPowerDownOnIdle = 10; // The target CPU is powered-down when there is no
                             // transmission between J-Link and target CPU for at least
10ms
```

5.11.1.15 SupplyPower

This command activates power supply over pin 19 of the JTAG connector. The KS (Kickstart) versions of J-Link have the V5 supply over pin 19 activated by default.

Typical applications

This feature is useful for some eval boards that can be powered over the JTAG connector.

Syntax

```
SupplyPower = 0 | 1
```

Example

```
SupplyPower = 1
```

5.11.1.16 SupplyPowerDefault

This command activates power supply over pin 19 of the JTAG connector permanently. The KS (Kickstart) versions of J-Link have the V5 supply over pin 19 activated by default.

Typical applications

This feature is useful for some eval boards that can be powered over the JTAG connector.

Syntax

```
SupplyPowerDefault = 0 | 1
```

Example

```
SupplyPowerDefault = 1
```

5.11.2 Using command strings

5.11.2.1 J-Link Commander

The J-Link command strings can be tested with the J-Link Commander. Use the command `exec` supplemented by one of the command strings.

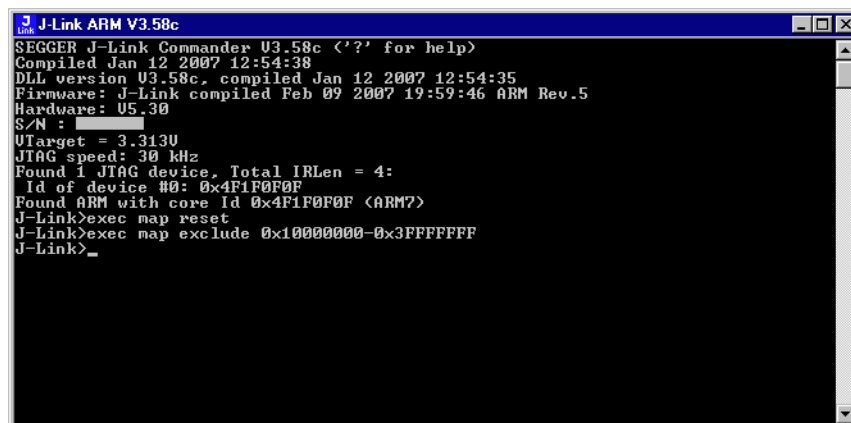

```
J-Link ARM V3.58c
SEGGER J-Link Commander V3.58c ('?' for help)
Compiled Jan 12 2007 12:54:38
DLL version V3.58c, compiled Jan 12 2007 12:54:35
Firmware: J-Link compiled Feb 09 2007 19:59:46 ARM Rev.5
Hardware: U5.30
S/N : 
UTarget = 3.313U
JTAG speed: 30 kHz
Found 1 JTAG device, Total IRLen = 4:
  Id of device #0: 0x4F1F0F0F
Found ARM with core Id 0x4F1F0F0F <ARM7>
J-Link>exec map reset
J-Link>exec map exclude 0x10000000-0x3FFFFFFF
J-Link>_
```

Example

```
exec SupplyPower = 1
exec map reset
exec map exclude 0x10000000-0x3FFFFFFF
```

5.11.2.2 IAR Embedded Workbench

The J-Link command strings can be supplied using the C-SPY debugger of the IAR Embedded Workbench. Open the **Project options** dialog box and select **Debugger**.

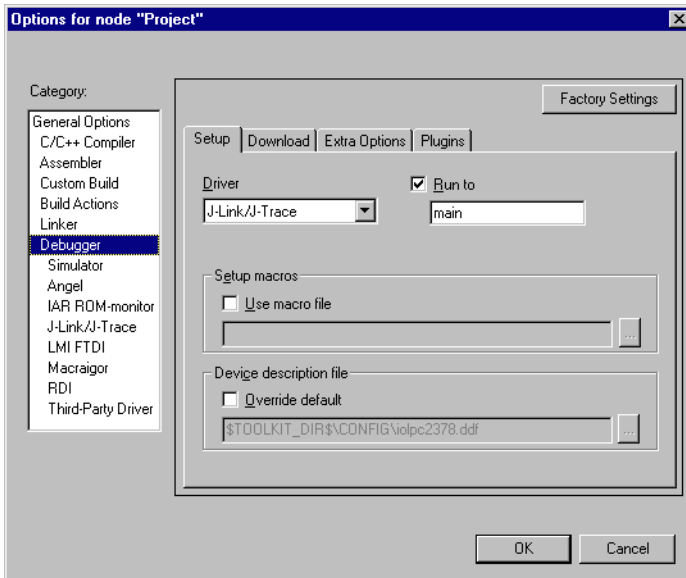

On the **Extra Options** page, select **Use command line options**.

Enter `--jlink_exec_command "<CommandLineOption>"` in the textfield, as shown in the screenshot below. If more than one command should be used separate the commands with semicolon.

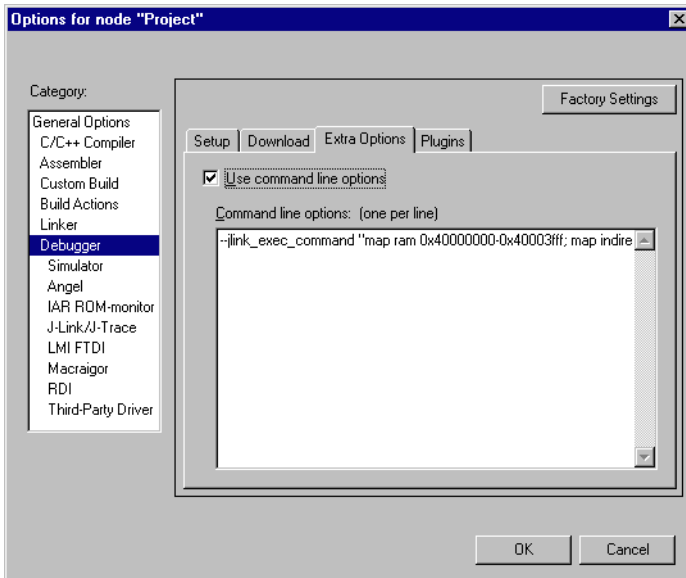

5.12 Switching off CPU clock during debug

We recommend not to switch off CPU clock during debug. However, if you do, you should consider the following:

Non-synthesizable cores (ARM7TDMI, ARM9TDMI, ARM920, etc.)

With these cores, the TAP controller uses the clock signal provided by the emulator, which means the TAP controller and ICE-Breaker continue to be accessible even if the CPU has no clock.

Therefore, switching off CPU clock during debug is normally possible if the CPU clock is periodically (typically using a regular timer interrupt) switched on every few ms for at least a few us. In this case, the CPU will stop at the first instruction in the ISR (typically at address 0x18).

Synthesizable cores (ARM7TDMI-S, ARM9E-S, etc.)

With these cores, the clock input of the TAP controller is connected to the output of a three-stage synchronizer, which is fed by clock signal provided by the emulator, which means that the TAP controller and ICE-Breaker are not accessible if the CPU has no clock.

If the RTCK signal is provided, adaptive clocking function can be used to synchronize the JTAG clock (provided by the emulator) to the processor clock. This way, the JTAG clock is stopped if the CPU clock is switched off.

If adaptive clocking is used, switching off CPU clock during debug is normally possible if the CPU clock is periodically (typically using a regular timer interrupt) switched on every few ms for at least a few us. In this case, the CPU will stop at the first instruction in the ISR (typically at address 0x18).

5.13 Cache handling

Most target systems with external memory have at least one cache. Typically, ARM7 systems with external memory come with a unified cache, which is used for both code and data. Most ARM9 systems with external memory come with separate caches for the instruction bus (I-Cache) and data bus (D-Cache) due to the hardware architecture.

5.13.1 Cache coherency

When debugging or otherwise working with a system with processor with cache, it is important to maintain the cache(s) and main memory coherent. This is easy in systems with a unified cache and becomes increasingly difficult in systems with hardware architecture. A write buffer and a D-Cache configured in write-back mode can further complicate the problem.

ARM9 chips have no hardware to keep the caches coherent, so that this is the responsibility of the software.

5.13.2 Cache clean area

J-Link / J-Trace handles cache cleaning directly through JTAG commands. Unlike other emulators, it does not have to download code to the target system. This makes setting up J-Link / J-Trace easier. Therefore, a cache clean area is not required.

5.13.3 Cache handling of ARM7 cores

Because ARM7 cores have a unified cache, there is no need to handle the caches during debug.

5.13.4 Cache handling of ARM9 cores

ARM9 cores with cache require J-Link / J-Trace to handle the caches during debug. If the processor enters debug state with caches enabled, J-Link / J-Trace does the following:

When entering debug state

J-Link / J-Trace performs the following:

- it stores the current write behavior for the D-Cache
- it selects write-through behavior for the D-Cache.

When leaving debug state

J-Link / J-Trace performs the following:

- it restores the stored write behavior for the D-Cache
- it invalidates the D-Cache.

Note: The implementation of the cache handling is different for different cores. However, the cache is handled correctly for all supported ARM9 cores.

5.14 Virtual COM Port (VCOM)

5.14.1 Configuring Virtual COM Port

In general, the VCOM feature can be disabled and enabled for debug probes which comes with support for it via J-Link Commander and J-Link Configurator. Below, a small description howto use them to configure the feature is given.

Note: VCOM can only be used when debugging via SWD target interface. Pin 5 = J-Link-Tx (out), Pin 17 = J-Link-Rx (in).

Note: Currently, only J-Link models with hardware version 9 or newer comes with VCOM capabilities.

5.14.1.1 Via J-Link Configurator

The J-Link software and documentation package comes with a free GUI-based utility called J-Link Configurator which auto-detects all J-Links that are connected to the host PC via USB & Ethernet. The J-Link Configurator allows the user to enable and disable the VCOM. For more information about the J-Link Configurator, please refer to *J-Link Configurator* on page 127.

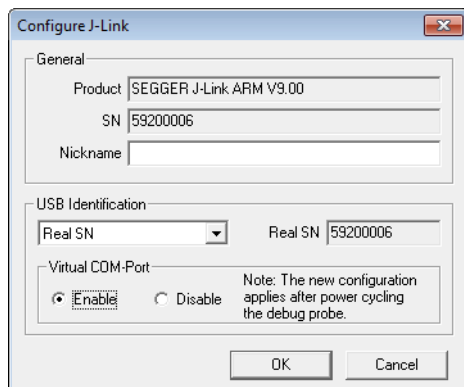

5.14.1.2 Via J-Link Commander

Simply start J-Link Commander, which is part of the J-Link software and documentation package and enter the `vcom enable|disable` command as in the screenshot below. After changing the configuration a power on cycle of the debug probe is necessary in order to use the new configuration. For feature information about how to use the J-Link Commander, please refer to *J-Link Commander (Command line tool)* on page 63.

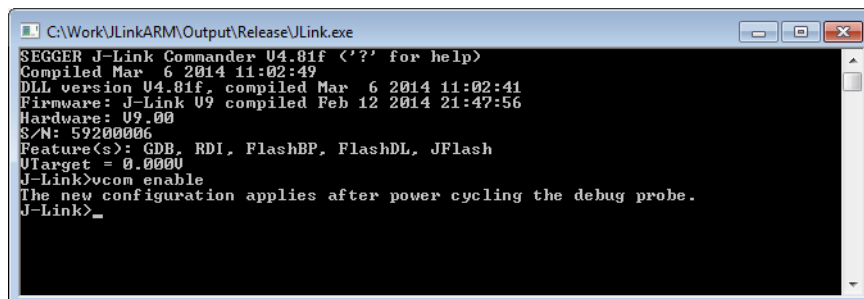

Chapter 6

Flash download

This chapter describes how the flash download feature of the DLL can be used in different debugger environments.

6.1 Introduction

The J-Link DLL comes with a lot of flash loaders that allow direct programming of internal flash memory for popular microcontrollers. Moreover, the J-Link DLL also allows programming of CFI-compliant external NOR flash memory. The flash download feature of the J-Link DLL does not require an extra license and can be used free of charge.

Why should I use the J-Link flash download feature?

Being able to download code directly into flash from the debugger or integrated IDE significantly shortens the turn-around times when testing software. The flash download feature of J-Link is very efficient and allows fast flash programming. For example, if a debugger splits the download image into several pieces, the flash download software will collect the individual parts and perform the actual flash programming right before program execution. This avoids repeated flash programming. Once the setup of flash download is completed. Moreover, the J-Link flash loaders make flash behave as RAM. This means that the debugger only needs to select the correct device which enables the J-Link DLL to automatically activate the correct flash loader if the debugger writes to a specific memory address.

This also makes it very easy for debugger vendors to make use of the flash download feature because almost no extra work is necessary on the debugger side since the debugger has not to differ between memory writes to RAM and memory writes to flash.

6.2 Licensing

No extra license required. The flash download feature can be used free of charge.

6.3 Supported devices

J-Link supports download into the internal flash of a large number of microcontrollers. You can always find the latest list of supported devices on our website:

http://www.segger.com/jlink_supported_devices.html

In general, J-Link can be used with any ARM7/9/11, Cortex-M0/M1/M3/M4 and Cortex-A5/A8/R4 core even if it does not provide internal flash.

Furthermore, flash download is also available for all CFI-compliant external NOR-flash devices.

6.4 Setup for various debuggers (internal flash)

The J-Link flash download feature can be used by different debuggers, such as IAR Embedded Workbench, Keil MDK, GDB based IDEs, ... For different debuggers there are different steps required to enable J-Link flash download. In this section, the setup for different debuggers is explained.

6.4.1 IAR Embedded Workbench

Using the J-Link flash download feature in IAR EWARM is quite simple:

First, choose the right device in the project settings if not already done. The device settings can be found at **Project->Options->General Options->Target**.

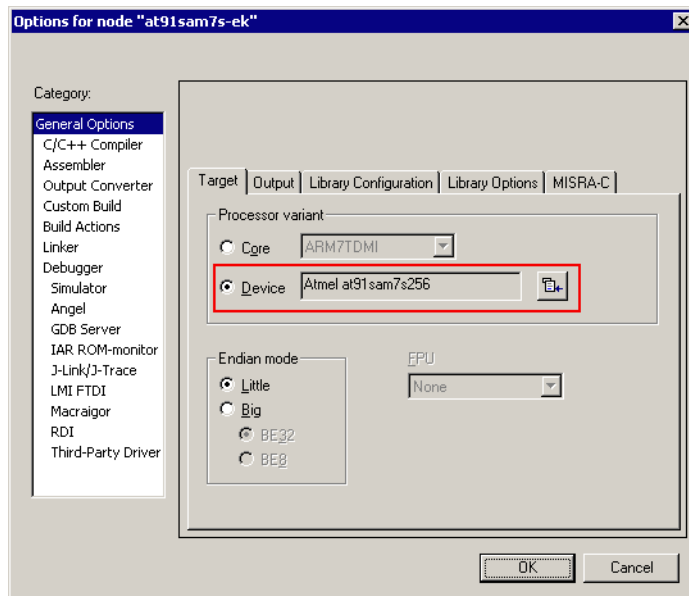

To use the J-Link flash loaders, the IAR flash loader has to be disabled. To disable the IAR flash loader, the checkbox **Use flash loader(s)** at **Project->Options->Debugger->Download** has to be disabled, as shown below.

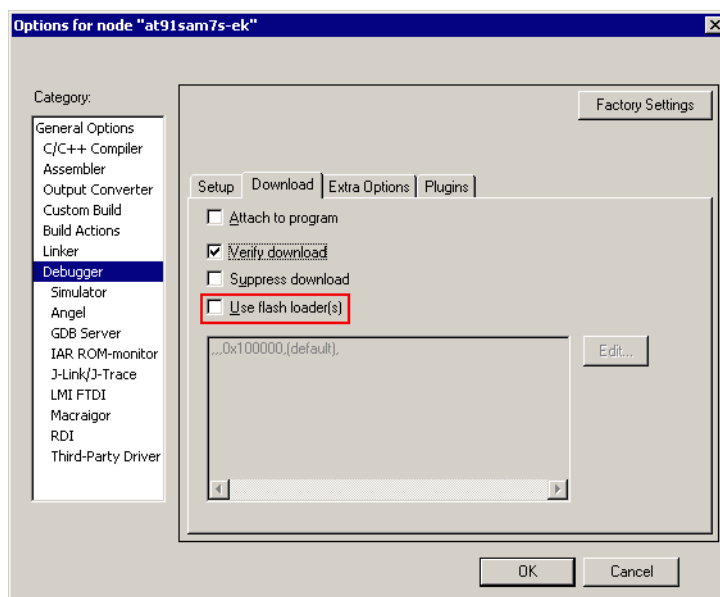

6.4.2 Keil MDK

To use the J-Link flash download feature in Keil MDK, the following steps need to be performed:

First, choose the device in the project settings if not already done. The device settings can be found at **Project->Options for Target->Device**.

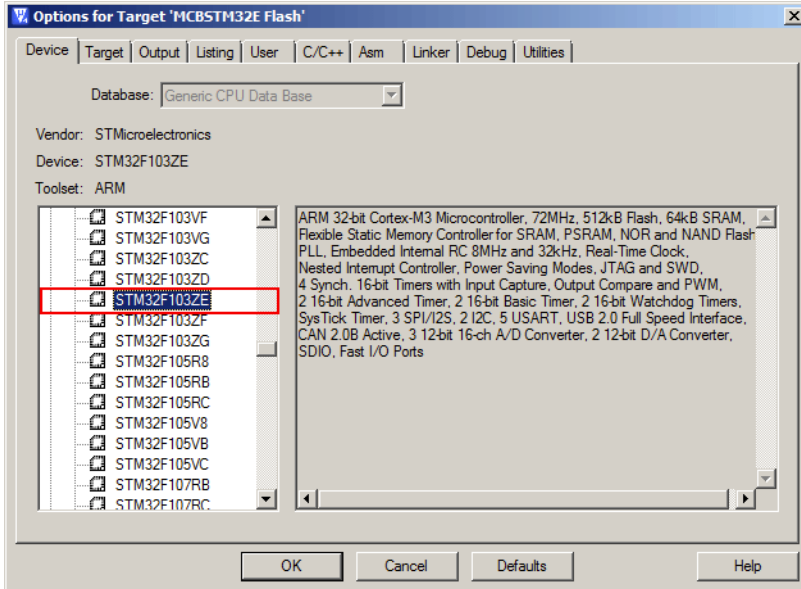

To enable the J-Link flash loader **J-Link / J-Trace** at **Project->Options for Target->Utilities** has to be selected. It is important that "Update Target before Debugging" is unchecked since otherwise uVision tries to use its own flashloader.

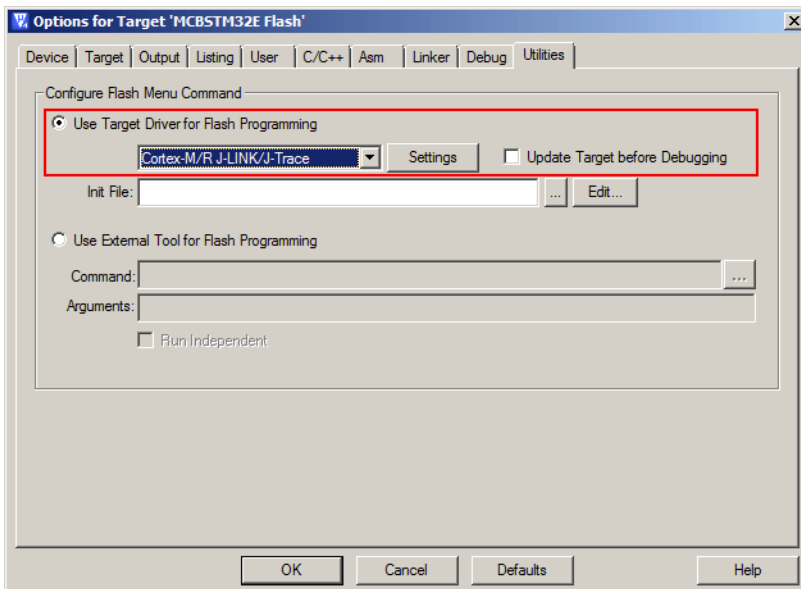

Then J-Link has to be selected as debugger. To select J-Link as debugger simply choose J-Link / J-Trace from the list box which can be found at **Project->Options for Target->Debug**.

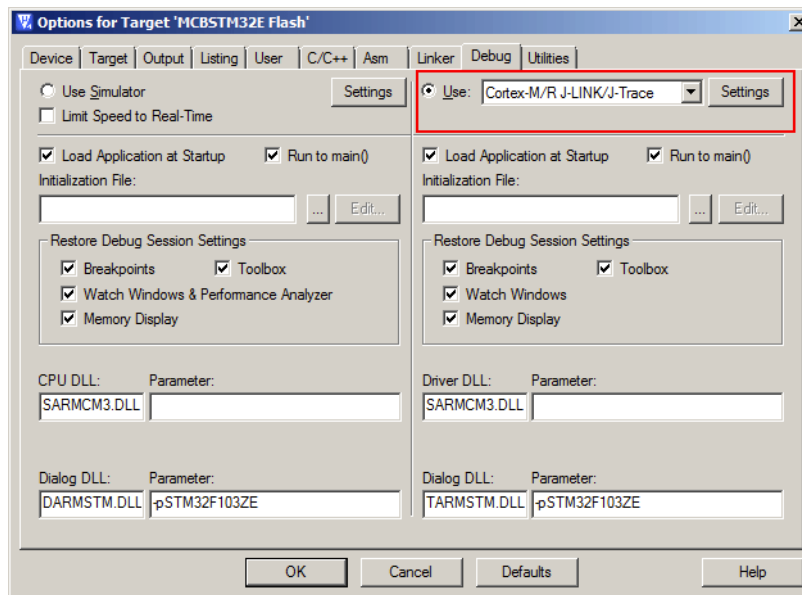

Now setup the **Download Options** at **Project->Options for Target->Debug -> Settings**. Check **Verify Code Download** and **Download to Flash** as shown in the screenshot below.

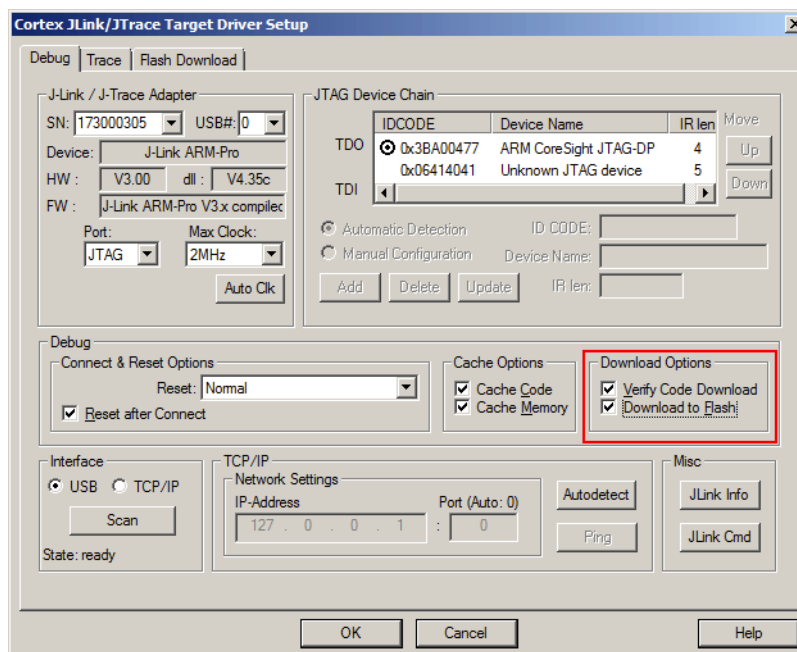

6.4.3 Mentor Sourcery CodeBench

To use the J-Link flash download feature in Mentor Sourcery CodeBench, the following steps need to be performed:

Current versions of Sourcery CodeBench do not pass the device name selected in CodeBench, to the J-Link DLL. Therefore a device override via J-Link settings file is needed.

- Copy the J-Link settings file template from
`$JLINK_INST_DIR$\Samples\JLink\SettingsFiles\Sample.jlinksettings`
 to the directory where the CodeBench project is located.
- Open the `Sample.jlinksettings` in a text editor and scroll to the [FLASH] section
- Change the line
`Device="UNSPECIFIED"`
 to the device name that shall be selected (keep the quotation marks). A list of valid device names can be found here: http://www.segger.com/jlink_supported_devices.html (List of known devices)
- Change the line
`Override = 0`
 to
`Override = 1`
- Select the settings file to be used in Sourcery CodeBench:

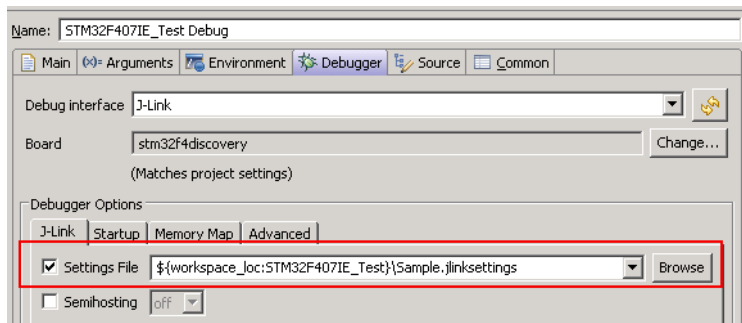

Additional steps for enabling Flash Breakpoints feature

By default, Mentor Sourcery CodeBench does not allow the user to use the J-Link unlimited number of breakpoints in flash feature, since it only allows hardware breakpoints being set, by default. Enabling this feature, requires an additional tweak in the J-Link settings file:

- Make sure that all steps from *Mentor Sourcery CodeBench* on page 194, to enable flash download, have been performed.
- Make sure that Sourcery CodeBench uses a J-Link DLL with version V4.85d or later. If an earlier version is used, this tweak does not work.
 To update the DLL used by CodeBench, copy the J-Link DLL from the J-Link installation directory to:
`C:\Tool\C\Mentor\CodeBench\bin\arm-none-eabi-jlinkarm.dll`
- Open the settings file in a text editor and scroll to the [BREAKPOINTS] section.
- Add the line:
`ForceImpTypeAny = 1`
- Make sure that CodeBench uses the settings file.

6.4.4 J-Link GDB Server

The configuration for the J-Link GDB Server is done by the `.gdbinit` file. The following command has to be added to the `.gdbinit` file to enable the J-Link flash download feature:

```
monitor flash device <DeviceName>
```

<DeviceName> is the name of the device for which download into internal flash memory shall be enabled. For a list of supported devices, please refer to *Supported devices* on page 190. For more information about the GDB monitor commands please refer to *J-Link GDB Server* on page 66.

6.4.5 J-Link Commander

J-Link Commander supports downloading bin files into internal flash memory of popular microcontrollers. In the following, it is explained which steps are necessary to prepare J-Link Commander for download into internal flash memory.

6.4.5.1 Preparing J-Link Commander for flash download

To configure J-Link Commander for flash download simply select the connected device by typing in the following command:

```
exec device = <DeviceName>
```

<DeviceName> is the name of the device for which download into internal flash memory shall be enabled. For a list of supported devices, please refer to *Supported devices* on page 190. In order to start downloading the binary data file into flash, please type in the following command:

```
loadbin <filename>, <addr>
```

<Filename> is the path of the binary data file which should be downloaded into the flash.<Addr> is the start address, the data file should be written to.

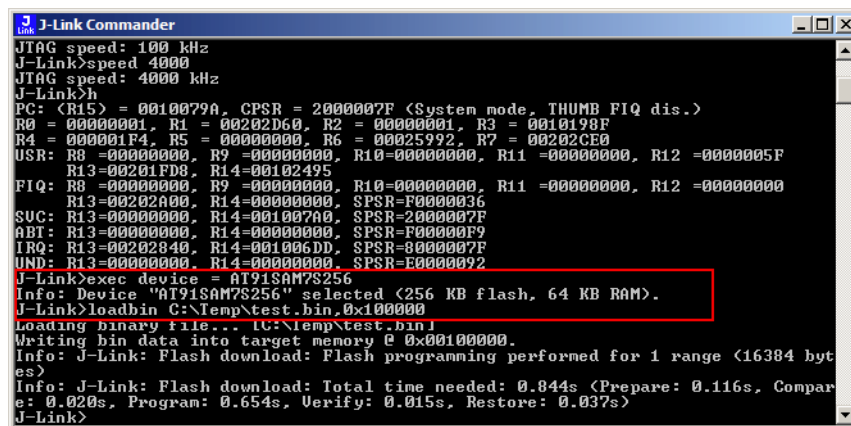

```
J-Link Commander
JTAG speed: 100 kHz
J-Link>speed 4000
JTAG speed: 4000 kHz
J-Link>h
PC: (R15) = 0010079A, CPSR = 2000007F (System mode, THUMB FIQ dis.)
R0 = 00000001, R1 = 00202D60, R2 = 00000001, R3 = 0010198F
R4 = 000001F4, R5 = 00000000, R6 = 00025992, R7 = 00202CE0
USR: R8 = 00000000, R9 = 00000000, R10=00000000, R11 = 00000000, R12 = 0000005F
R13=00201FD8, R14=00102495
FIQ: R8 = 00000000, R9 = 00000000, R10=00000000, R11 = 00000000, R12 = 00000000
R13=00202A00, R14=00000000, SPSR=F0000036
SUC: R13=00000000, R14=001007A0, SPSR=2000007F
ABT: R13=00000000, R14=00000000, SPSR=F00000F9
IRQ: R13=00202840, R14=001006DD, SPSR=8000007F
UND: R13=00000000, R14=00000000, SPSR=F0000092
J-Link>exec device = AT91SAM7S256
Info: Device "AT91SAM7S256" selected (256 KB flash, 64 KB RAM).
J-Link>loadbin C:\Temp\test.bin,0x100000
Loading binary file... IC:\Temp\test.bin
Writing bin data into target memory @ 0x00100000.
Info: J-Link: Flash download: Flash programming performed for 1 range (16384 bytes)
Info: J-Link: Flash download: Total time needed: 0.844s (Prepare: 0.116s, Compare: 0.020s, Program: 0.654s, Verify: 0.015s, Restore: 0.037s)
J-Link>
```

6.4.5.2 Converting non-bin files

As previously mentioned, J-Link Commander supports programming of bin files into flash memory. If the data file to be programmed is in non-bin format (.hex, .mot, .srec), the file needs to be converted into binary first. There are various free software utilities available which allow data file conversion. Another possibility is to use J-Flash which is part of the J-Link software and documentation package. For converting data files, no J-Flash license is needed.

In order to convert a hex/mot/... file into a bin file using J-Flash, the following needs to be done:

1. Start J-Flash
2. Click **File | Open data file...** to open the data file to be converted in J-Flash.
3. Click **File | Save data file as...**
4. Select Binary file (*.bin) as file type so J-Flash knows that the file shall be saved as binary (bin) file.
5. Click **Save**

6.4.6 J-Link RDI

The configuration for J-Link RDI is done via the J-Link RDI configuration dialog.

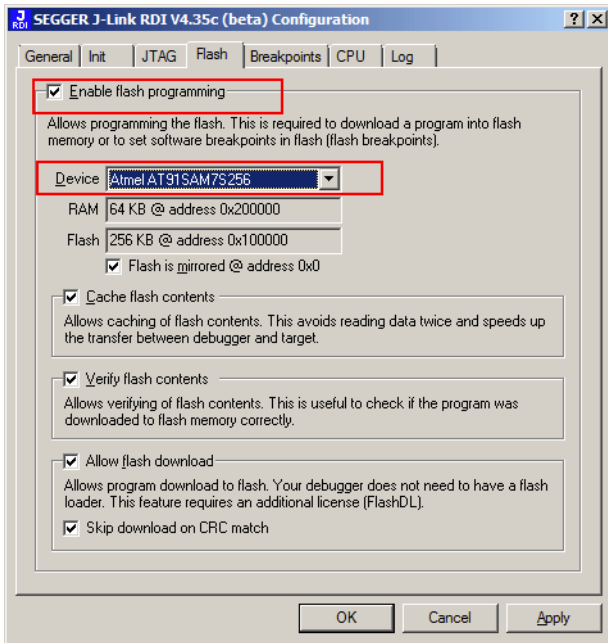

For more information about the J-Link RDI configuration dialog please refer to *UM08004, J-Link RDI User Guide*, chapter *Configuration dialog*.

6.5 Setup for various debuggers (CFI flash)

The setup for download into CFI-compliant memory is different from the one for internal flash. In this section, the setup for different debuggers is explained.

6.5.1 IAR Embedded Workbench / Keil MDK

Using the J-Link flash download feature with IAR Embedded Workbench / Keil MDK is quite simple:

First, start the debug session and open the J-Link Control Panel. In the tab "Settings" you will find the location of the settings file.

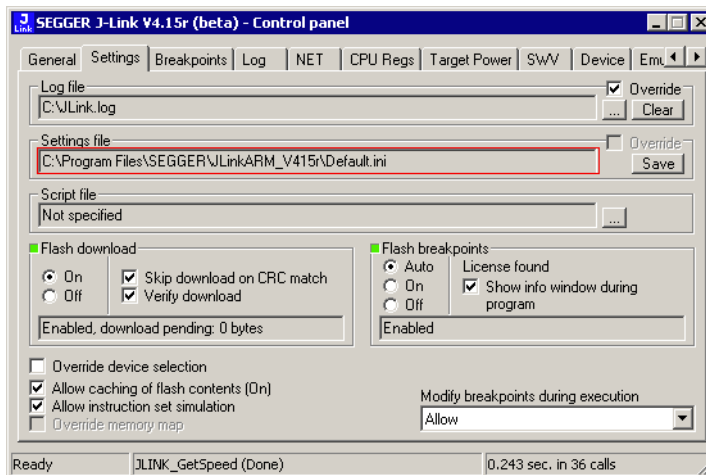

Close the debug session and open the settings file with a text editor. Add the following lines to the file:

```
[CFI]
CFISize = <FlashSize>
CFIAddr = <FlashAddr>
[GENERAL]
WorkRAMSize = <RAMSize>
WorkRAMAddr = <RAMAddr>
```

After this the file should look similar to the sample in the following screenshot.

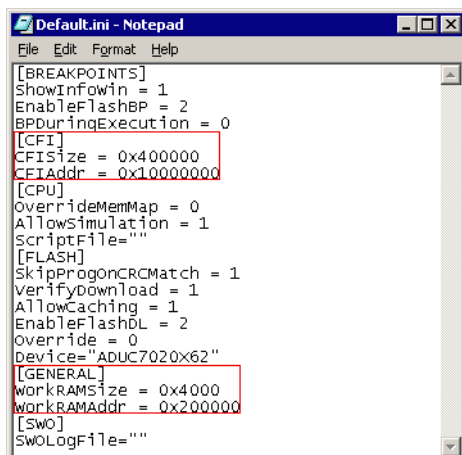

Save the settings file and restart the debug session. Open the J-Link Control Panel and verify that the "MemMap" tab shows the new settings for CFI flash and work RAM area.

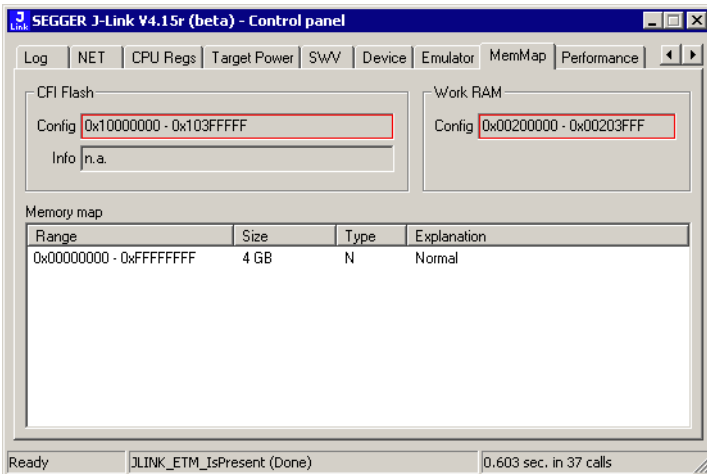

6.5.2 J-Link GDB Server

The configuration for the J-Link GDB Server is done by the `.gdbinit` file. The following commands have to be added to the `.gdbinit` file to enable the flash download feature:

```
monitor WorkRAM = <SAddr>-<EAddr>
monitor flash CFI = <SAddr>-<EAddr>
```

For more information about the GDB monitor commands please refer to *J-Link GDB Server* on page 66.

6.5.3 J-Link commander

J-Link Commander supports downloading bin files into external CFI flash memory. In the following, it is explained which steps are necessary to prepare J-Link Commander for download into external CFI flash memory based on a sample sequence for a ST STM32F103ZE device:

```
r
speed 1000
exec setcfiflash 0x64000000 - 0x64FFFFFF
exec setworkram 0x20000000 - 0x2000FFFF
w4 0x40021014, 0x00000114 // RCC_AHBENR, FSMC clock enable
w4 0x40021018, 0x000001FD // GPIOD~G clock enable
w4 0x40011400, 0xB4BB44BB // GPIOD low config, NOE, NWE => Output, NWAIT => Input
w4 0x40011404, 0BBBBBBBB // GPIOD high config, A16-A18
w4 0x40011800, 0BBBBBBBB // GPIOE low config, A19-A23
w4 0x40011804, 0BBBBBBBB // GPIOE high config, D5-D12
w4 0x40011C00, 0x44BBBBBB // GPIOF low config, A0-A5
w4 0x40011C04, 0BBBB4444 // GPIOF high config, A6-A9
w4 0x40012000, 0x44BBBBBB // GPIOG low config, A10-A15
w4 0x40012004, 0x444B4BB4 // GPIOG high config, NE2 => output
w4 0xA0000008, 0x00001059 // CS control reg 2, 16-bit, write enable, Type: NOR flash
w4 0xA000000C, 0x10000505 // CS2 timing reg (read access)
w4 0xA000010C, 0x10000505 // CS2 timing reg (write access)
speed 4000
mem 0x64000000,100
loadbin C:\STMB672_STM32F103ZE_TestBlinky.bin,0x64000000
mem 0x64000000,100
```

6.5.3.1 Converting non-bin files

As previously mentioned, J-Link Commander supports programming of bin files into flash memory. If the data file to be programmed is in non-bin format (`.hex`, `.mot`, `.srec`), the file needs to be converted into binary first. There are various free soft-

ware utilities available which allow data file conversion. Another possibility is to use J-Flash which is part of the J-Link software and documentation package. For converting data files, no J-Flash license is needed.

In order to convert a hex/mot/... file into a bin file using J-Flash, the following needs to be done:

1. Start J-Flash
2. Click **File | Open data file...** to open the data file to be converted in J-Flash.
3. Click **File | Save data file as...**
4. Select Binary file (*.bin) as file type so J-Flash knows that the file shall be saved as binary (bin) file.
5. Click **Save**

6.6 Using the DLL flash loaders in custom applications

The J-Link DLL flash loaders make flash behave as RAM from a user perspective, since flash programming is triggered by simply calling the J-Link API functions for memory reading / writing. For more information about how to setup the J-Link API for flash programming please refer to *UM08002 J-Link SDK* documentation (available for SDK customers only).

Chapter 7

Flash breakpoints

This chapter describes how the flash breakpoints feature of the DLL can be used in different debugger environments.

7.1 Introduction

The J-Link DLL supports a feature called flash breakpoints which allows the user to set an unlimited number of breakpoints in flash memory rather than only being able to use the hardware breakpoints of the device. Usually when using hardware breakpoints only, a maximum of 2 (ARM 7/9/11) to 8 (Cortex-A/R) breakpoints can be set. The flash memory can be the internal flash memory of a supported microcontroller or external CFI-compliant flash memory. In the following sections the setup for different debuggers to use the flash breakpoints feature is explained.

How do breakpoints work?

There are basically 2 types of breakpoints in a computer system: hardware breakpoints and software breakpoints. Hardware breakpoints require a dedicated hardware unit for every breakpoint. In other words, the hardware dictates how many hardware breakpoints can be set simultaneously. ARM 7/9 cores have 2 breakpoint units (called "watchpoint units" in ARM's documentation), allowing 2 hardware breakpoints to be set. Hardware breakpoints do not require modification of the program code. Software breakpoints are different: The debugger modifies the program and replaces the breakpointed instruction with a special value. Additional software breakpoints do not require additional hardware units in the processor, since simply more instructions are replaced. This is a standard procedure that most debuggers are capable of, however, this usually requires the program to be located in RAM.

What is special about software breakpoints in flash?

Flash breakpoints allows setting of an unlimited number of breakpoints even if the user application is not located in RAM. On modern microcontrollers this is the standard scenario because on most microcontrollers the internal RAM is not big enough to hold the complete application. When replacing instructions in flash memory this requires re-programming of the flash which takes much more time than simply replacing an instruction when debugging in RAM. The J-Link flash breakpoints feature is highly optimized for fast flash programming speed and in combination with the instruction set simulation only re-programs flash is absolutely necessary which makes debugging in flash using flash breakpoints almost as flawless as debugging in RAM.

What performance can I expect?

Flash algorithm, specially designed for this purpose, sets and clears flash breakpoints extremely fast; on microcontrollers with fast flash the difference between software breakpoints in RAM and flash is hardly noticeable.

How is this performance achieved?

We have put a lot of effort in making flash breakpoints really usable and convenient. Flash sectors are programmed only when necessary; this is usually the moment execution of the target program is started. A lot of times, more than one breakpoint is located in the same flash sector, which allows programming multiple breakpoints by programming just a single sector. The contents of program memory are cached, avoiding time consuming reading of the flash sectors. A smart combination of software and hardware breakpoints allows us to use hardware breakpoints a lot of times, especially when the debugger is source level-stepping, avoiding re-programming the flash in these situations. A built-in instruction set simulator further reduces the number of flash operations which need to be performed. This minimizes delays for the user, while maximizing the life time of the flash. All resources of the ARM microcontroller are available to the application program, no memory is lost for debugging.

7.2 Licensing

In order to use the flash breakpoints feature a separate license is necessary for each J-Link. For some devices J-Link comes with a device-based license and some J-Link models also come with a full license for flash breakpoints but the normal J-Link comes without any licenses. For more information about licensing itself and which devices have a device-based license, please refer to *Licensing* on page 47.

7.2.1 Free for evaluation and non-commercial use

In general, the unlimited flash breakpoints feature of the J-Link DLL can be used free of charge for evaluation and non-commercial use.

If used in a commercial project, a license needs to be purchased when the evaluation is complete. There is no time limit on the evaluation period. This feature allows setting an unlimited number of breakpoints even if the application program is located in flash memory, thereby utilizing the debugging environment to its fullest.

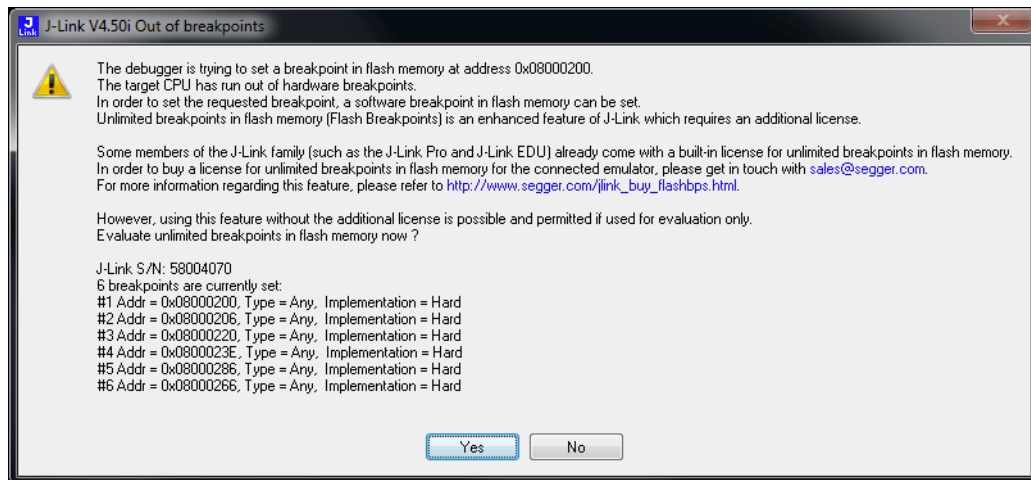

7.3 Supported devices

J-Link supports flash breakpoints for a large number of microcontrollers. You can always find the latest list of supported devices on our website:

http://www.segger.com/jlink_supported_devices.html

In general, J-Link can be used with any ARM7/9/11, Cortex-M0/M1/M3/M4 and Cortex-A5/A8/R4 core even if it does not provide internal flash.

Furthermore, flash breakpoints are also available for all CFI compliant external NOR-flash devices.

7.4 Setup & compatibility with various debuggers

7.4.1 Setup

In compatible debuggers, flash breakpoints work if the J-Link flash loader works and a license for flash breakpoints is present. No additional setup is required. The flash breakpoint feature is available for internal flashes and for external CFI-flash. For more information about how to setup various debuggers for flash download, please refer to *Setup for various debuggers (internal flash)* on page 191. If flash breakpoints are available can be verified using the J-Link control panel:

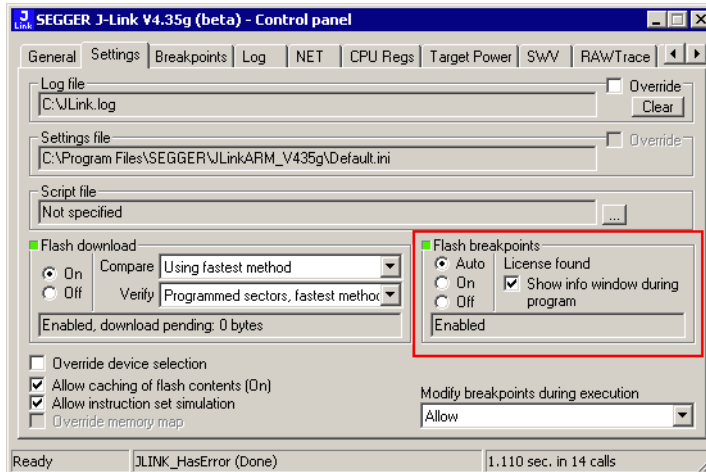

7.4.2 Compatibility with various debuggers

Flash breakpoints can be used in all debugger which use the proper J-Link API to set breakpoints. Compatible debuggers/ debug interfaces are:

- IAR Embedded Workbench
- Keil MDK
- GDB-based debuggers
- Freescale Codewarrior
- Mentor Graphics Sourcery CodeBench
- RDI-compliant debuggers

Incompatible debuggers / debug interfaces

- Rowley Crossworks

7.5 FAQ

- Q: Why can flash breakpoints not be used with Rowley Crossworks?
- A: Because Rowley Crossworks does not use the proper J-Link API to set breakpoints. Instead of using the breakpoint-API, Crossworks programs the debug hardware directly, leaving J-Link no choice to use its flash breakpoints.

Chapter 8

RDI

RDI (Remote Debug Interface) is a standard defined by ARM, trying to standardize a debugger / debug probe interface. It is defined for cores only that have the same CPU register set as ARM7 CPUs. This chapter describes how to use the RDI DLL which comes with the J-Link software and documentation package. The J-Link RDI DLL allows the user to use J-Link with any RDI-compliant debugger and IDE.

8.1 Introduction

Remote Debug Interface (RDI) is an Application Programming Interface (API) that defines a standard set of data structures and functions that abstract hardware for debugging purposes. J-Link RDI mainly consists of a DLL designed for ARM cores to be used with any RDI compliant debugger. The J-Link DLL feature flash download and flash breakpoints can also be used with J-Link RDI.

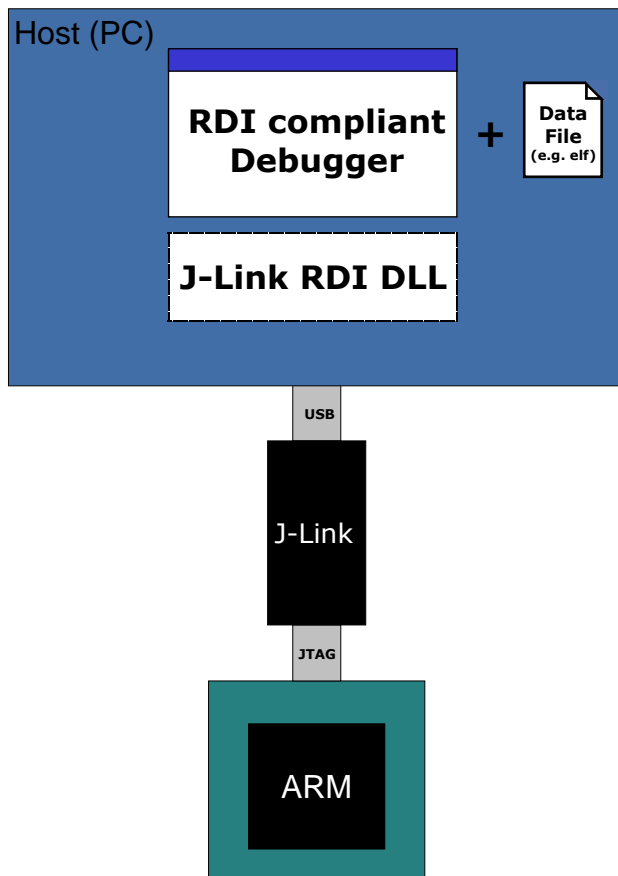

8.1.1 Features

- Can be used with every RDI compliant debugger
- Easy to use
- Flash download feature of J-Link DLL can be used
- Flash breakpoints feature of J-Link DLL can be used.
- Instruction set simulation (improves debugging performance)

8.2 Licensing

In order to use the J-Link RDI software a separate license is necessary for each J-Link. For some devices J-Link comes with a device-based license and some J-Link models also come with a full license for J-Link RDI but the normal J-Link comes without any licenses. For more information about licensing itself and which devices have a device-based license, please refer to *Licensing* on page 47.

8.3 Setup for various debuggers

The J-Link RDI software is an ARM Remote Debug Interface (RDI) for J-Link. It makes it possible to use J-Link with any RDI compliant debugger. Basically, J-Link RDI consists of a additional DLL (`JLinkRDI.dll`) which builds the interface between the RDI API and the normal J-Link DLL. The `JLinkRDI.dll` itself is part of the J-Link software and documentation package.

8.3.1 IAR Embedded Workbench IDE

J-Link RDI can be used with IAR Embedded Workbench for ARM.

8.3.1.1 Supported software versions

J-Link RDI has been tested with IAR Embedded Workbench IDE version 4.40. There should be no problems with other versions of IAR Embedded Workbench IDE. All screenshots are taken from IAR Embedded Workbench version 4.40.

Note: Since IAR EWARM V5.30 J-Link is fully and natively supported by EWARM, so RDI is no longer needed.

8.3.1.2 Configuring to use J-Link RDI

1. Start the IAR Embedded Workbench and open the tutor example project or the desired project. This tutor project has been preconfigured to use the simulator driver. In order to run the J-Link RDI you the driver needs to be changed.

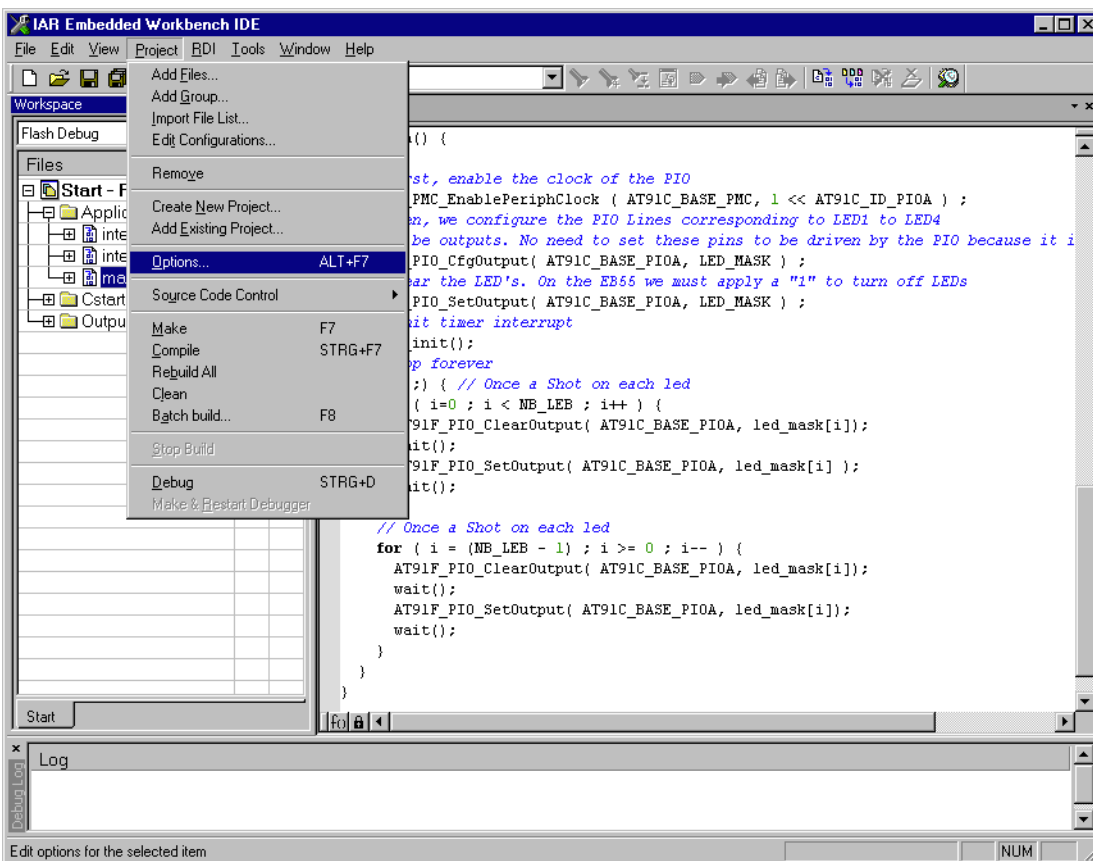

2. Choose **Project** | **Options** and select the **Debugger** category. Change the

Driver option to RDI.

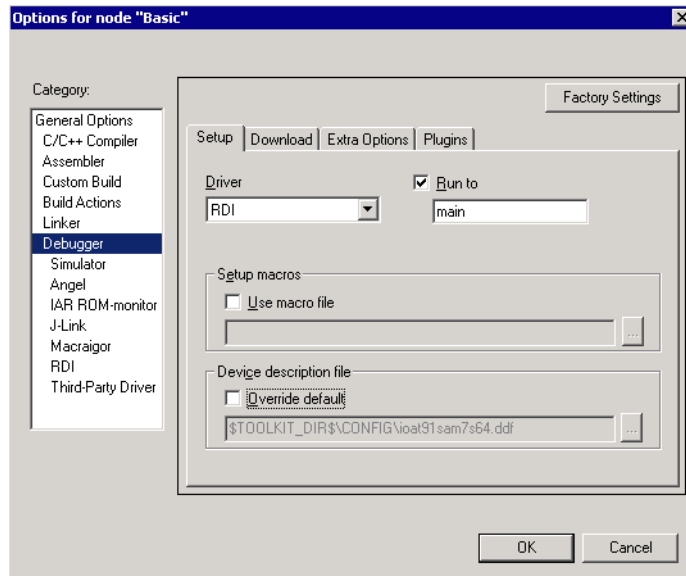

3. Go to the RDI page of the Debugger options, select the manufacturer driver (JLinkRDI.dll) and click **OK**.

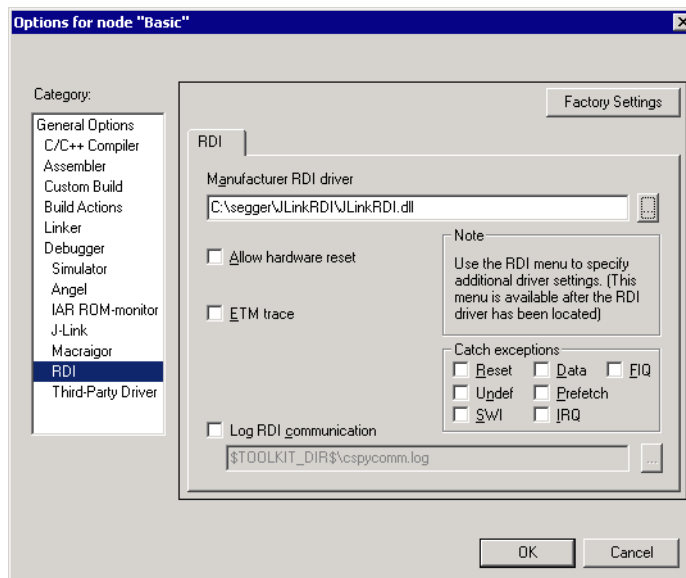

4. Now an extra menu, RDI, has been added to the menu bar. Choose **RDI | Configure** to configure the J-Link. For more information about the generic setup of J-Link RDI, please refer to *Configuration* on page 226.

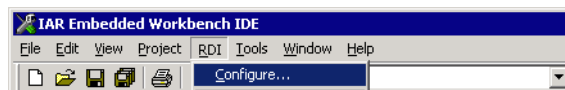

8.3.1.3 Debugging on Cortex-M3 devices

The RDI protocol has only been specified by ARM for ARM 7/9 cores. For Cortex-M there is no official extension of the RDI protocol regarding the register assignment, that has been approved by ARM. Since IAR EWARM version 5.11 it is possible to use J-Link RDI for Cortex-M devices because SEGGER and IAR have been come to an agreement regarding the RDI register assignment for Cortex-M. The following table lists the register assignment for RDI and Cortex-M:

Register Index	Assigned register
0	R0
1	R1
2	R2
3	R3
4	R4
5	R5
6	R6
7	R7
8	R8
9	R9
10	R10
11	R11
12	R12
13	MSP / PSP (depending on mode)
14	R14 (LR)
16	R15 (PC)
17	XPSR
18	APSR
19	IPSR
20	EPSR
21	IAPSR
22	EAPSR
23	IEPSR
24	PRIMASK
25	FAULTMASK
26	BASEPRI
27	BASEPRI_MAX
28	CFBP (CONTROL/FAULT/BASEPRI/PRIMASK)

Table 8.1: Cortex-M register mapping for IAR + J-Link RDI

8.3.2 ARM AXD (ARM Developer Suite, ADS)

8.3.2.1 Software version

The `JLinkRDI.dll` has been tested with ARM's AXD version 1.2.0 and 1.2.1. There should be no problems with other versions of ARM's AXD. All screenshots are taken from ARM's AXD version 1.2.0.

8.3.2.2 Configuring to use J-Link RDI

1. Start the ARM debugger and select **Options | Configure Target....** This opens the **Choose Target** dialog box:

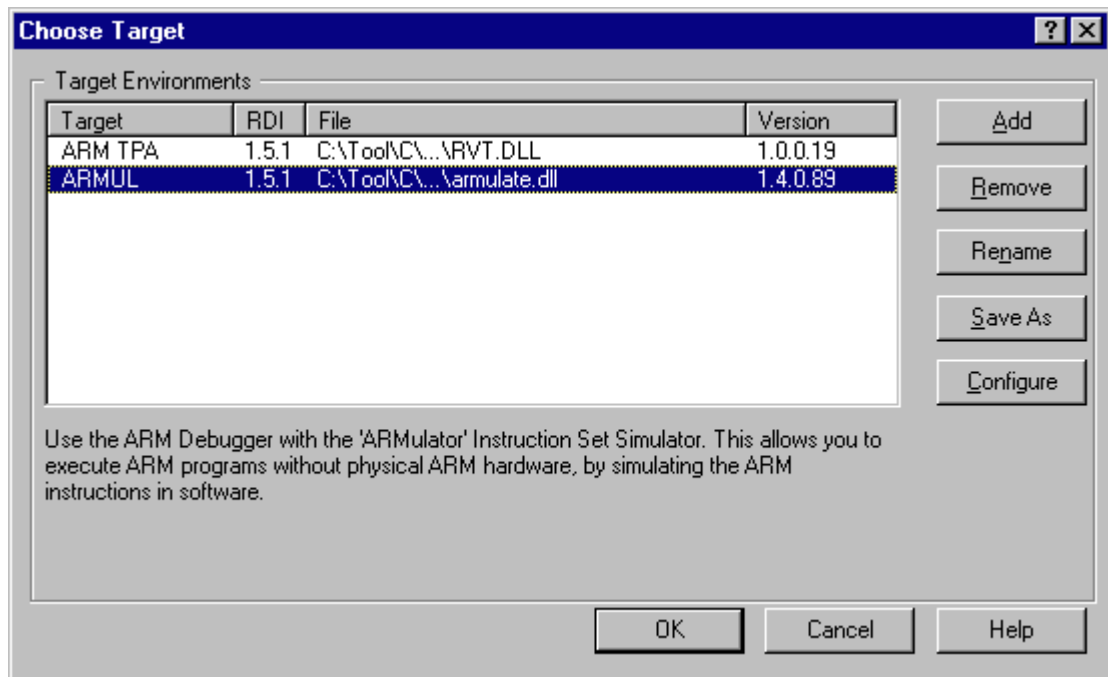

2. Press the **Add** Button to add the `JLinkRDI.dll`.

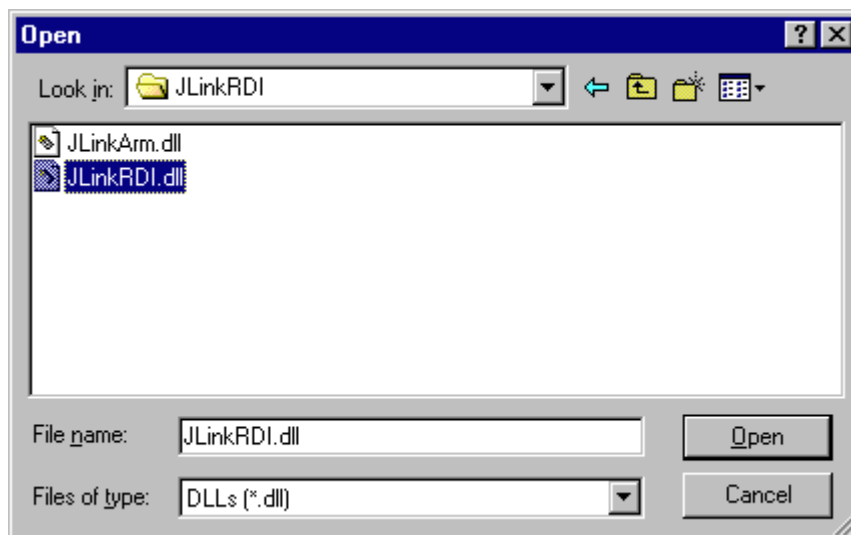

3. Now J-Link RDI is available in the **Target Environments** list.

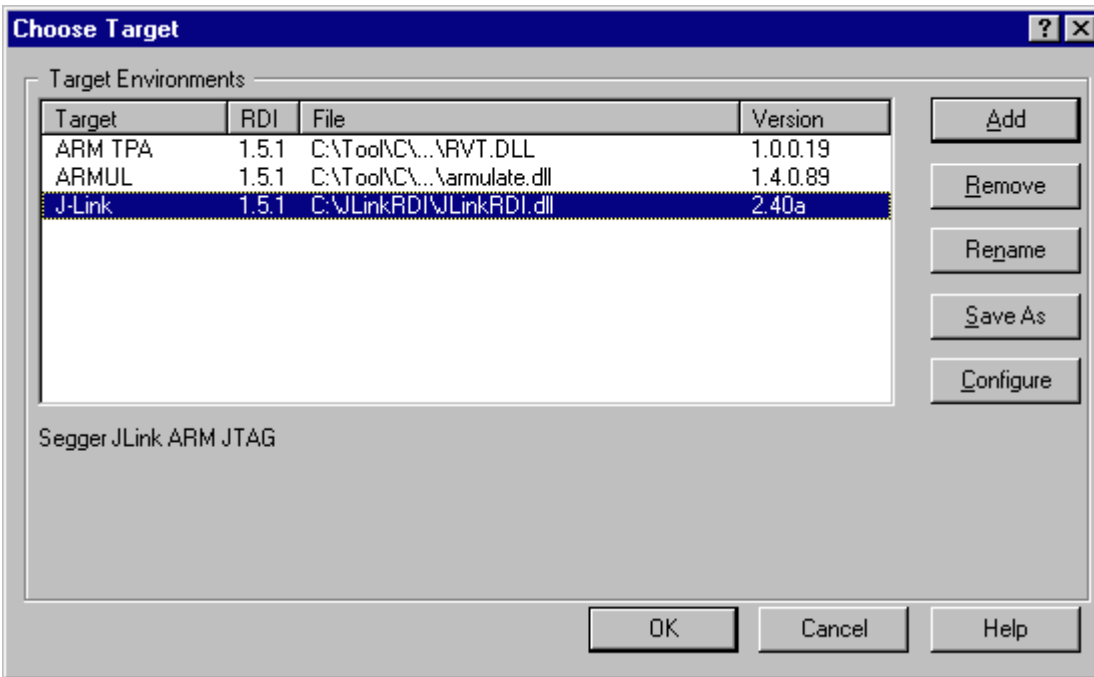

4. Select J-Link and press **OK** to connect to the target via J-Link. For more information about the generic setup of J-Link RDI, please refer to *Configuration* on page 226. After downloading an image to the target board, the debugger window looks as follows:

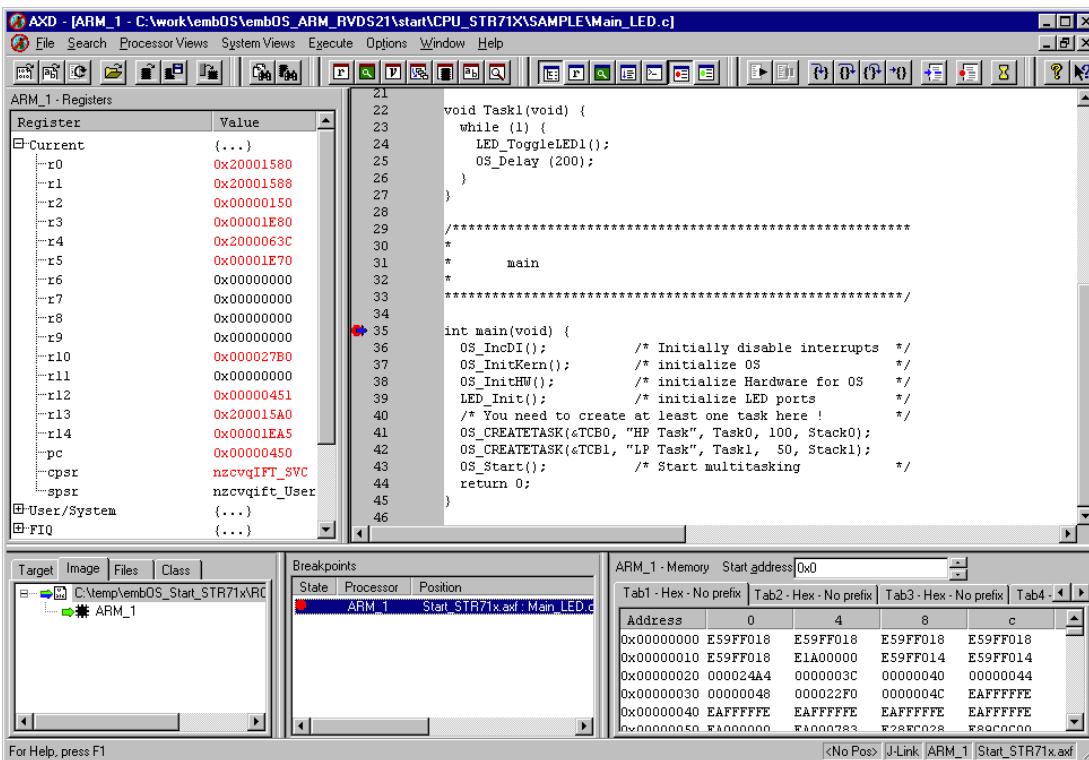

8.3.3 ARM RVDS (RealView developer suite)

8.3.3.1 Software version

J-Link RDI has been tested with ARM RVDS version 2.1 and 3.0. There should be no problems with earlier versions of RVDS (up to version v3.0.1). All screenshots are taken from ARM's RVDS version 2.1.

Note: RVDS version 3.1 does not longer support RDI protocol to communicate with the debugger.

8.3.3.2 Configuring to use J-Link RDI

1. Start the Real View debugger:

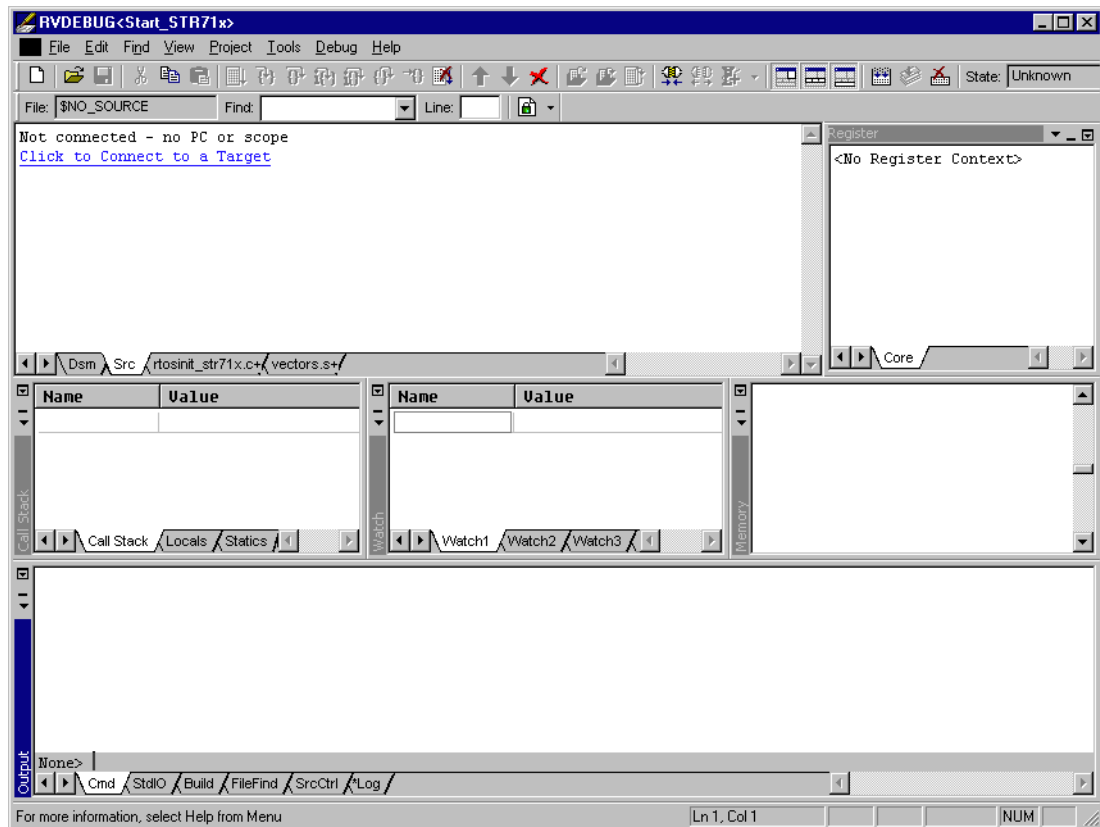

2. Select **File | Connection | Connect to Target.**

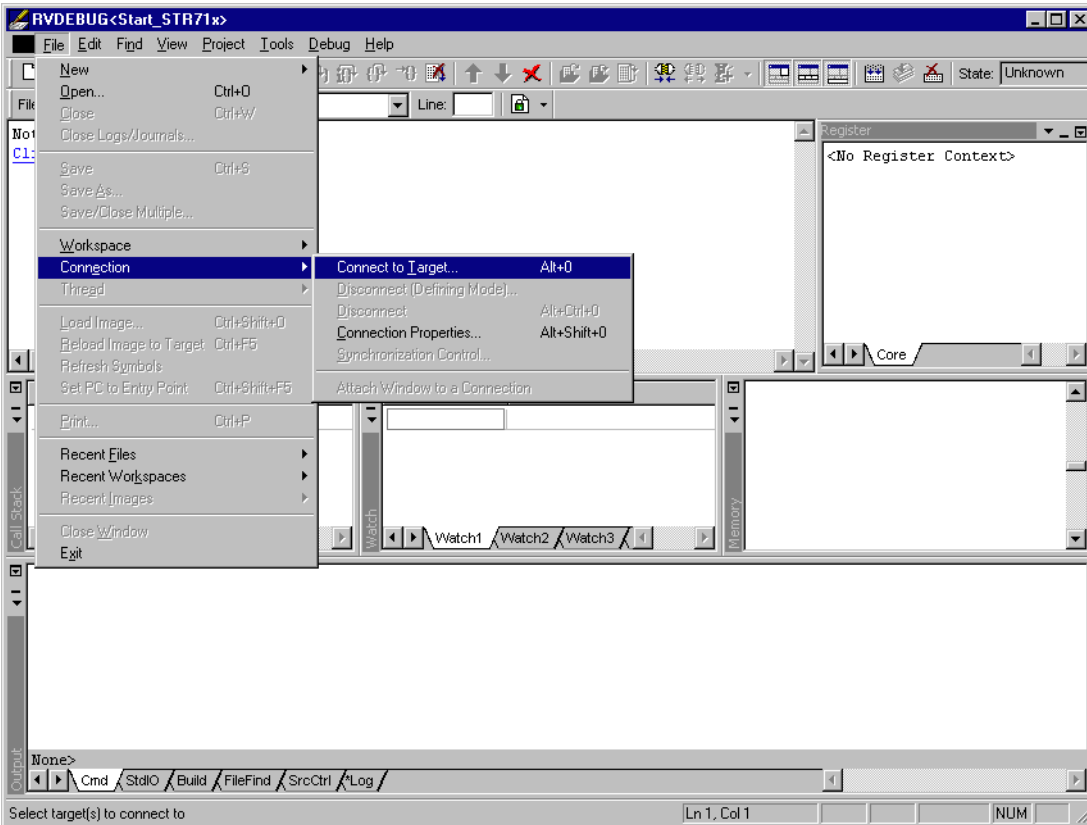

3. In the **Connection Control** dialog use the right mouse click on the first item and select **Add/Remove/Edit Devices**

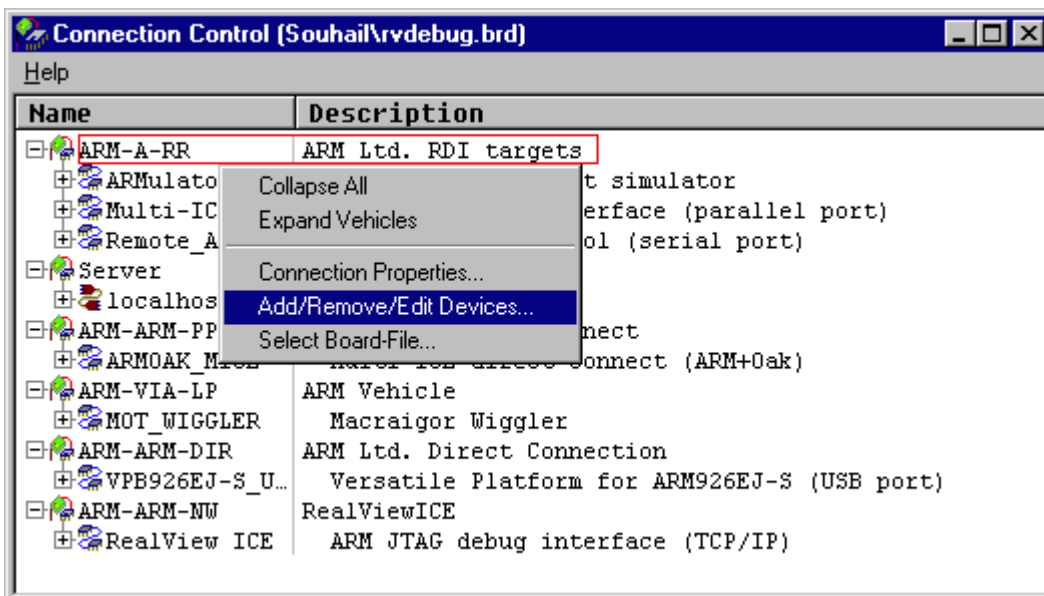

4. Now select **Add DLL** to add the `JLinkRDI.dll`. Select the installation path of the software, for example:

`C:\Program Files\SEGGER\JLinkARM_V350g\JLinkRDI.dll`

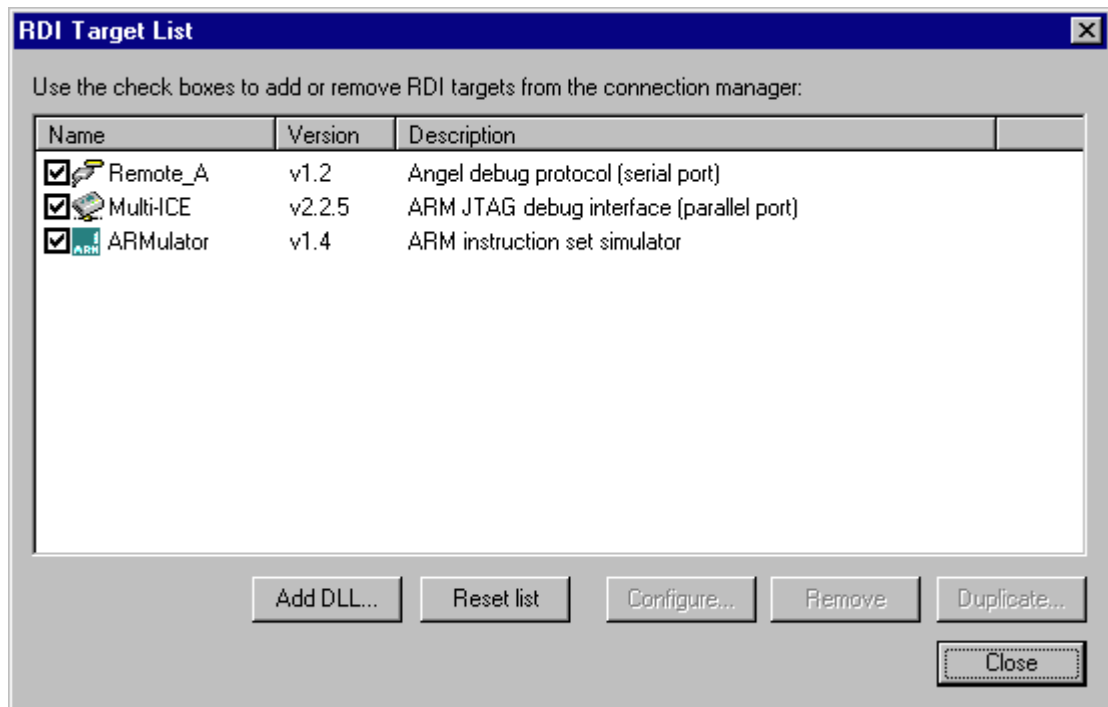

5. After adding the DLL, an additional Dialog opens and asks for description: (These values are voluntary, if you do not want change them, just click **OK**) Use the following values and click on **OK**, **Short Name:** `JLinkRDI` **Description:** `J-Link RDI Interface`.

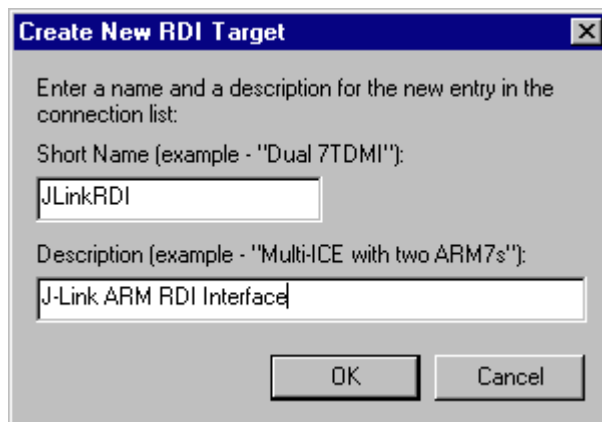

6. Back in the **RDI Target List** Dialog, select **JLink-RDI** and click **Configure**. For more information about the generic setup of J-Link RDI, please refer to *Configu-*

ration on page 226.

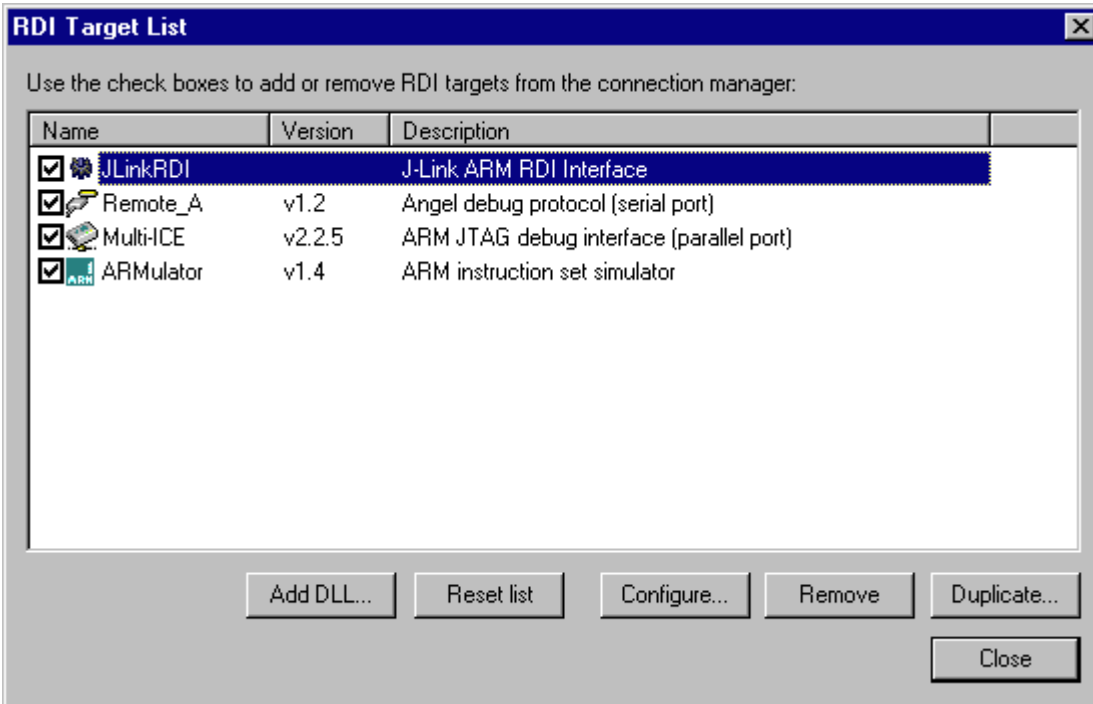

7. Click the **OK** button in the configuration dialog. Now close the **RDI Target List** dialog. Make sure your target hardware is already connected to J-Link.
8. In the **Connection control** dialog, expand the **JLink ARM RDI Interface** and select the ARM_0 Processor. Close the **Connection Control** Window.

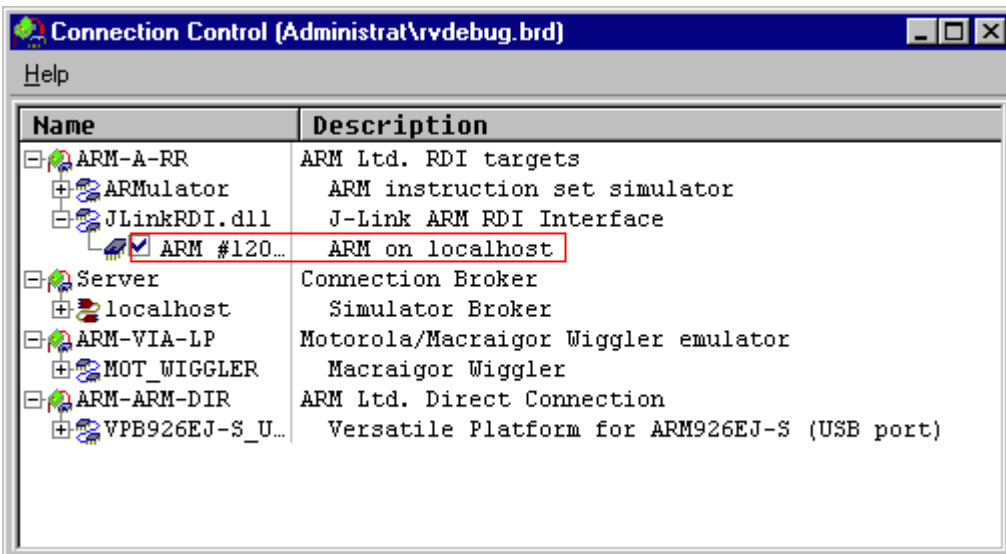

9. Now the RealView Debugger is connected to J-Link.

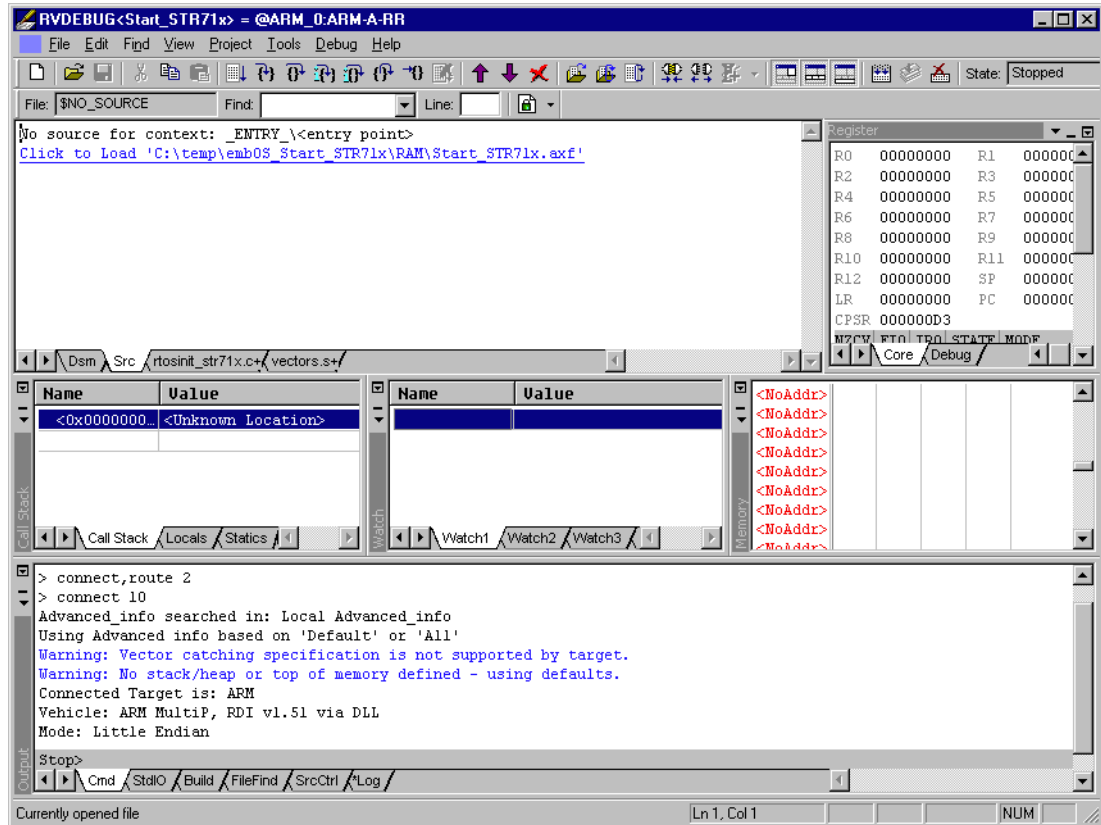

10. A project or an image is needed for debugging. After downloading, J-Link is used to debug the target.

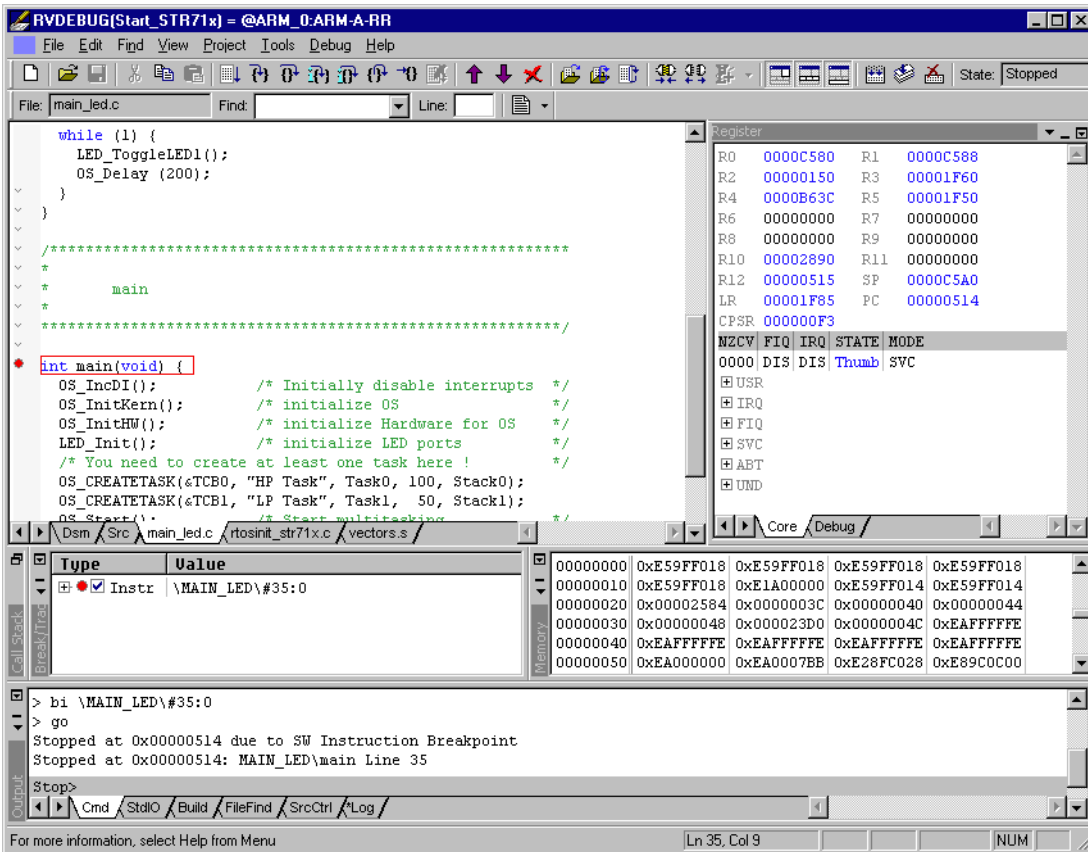

8.3.4 GHS MULTI

8.3.4.1 Software version

J-Link RDI has been tested with GHS MULTI version 4.07. There should be no problems with other versions of GHS MULTI. All screenshots are taken from GHS MULTI version 4.07.

8.3.4.2 Configuring to use J-Link RDI

1. Start Green Hills Software MULTI integrated development environment. Click **Connect | Connection Organizer** to open the **Connection Organizer**.

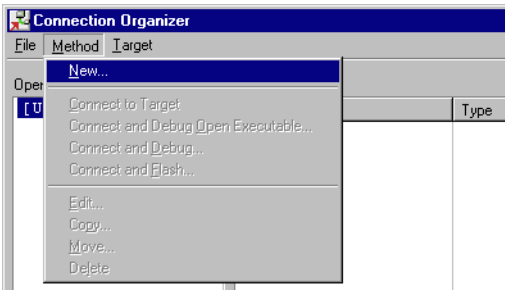

- Click **Method | New** in the **Connection Organizer** dialog.

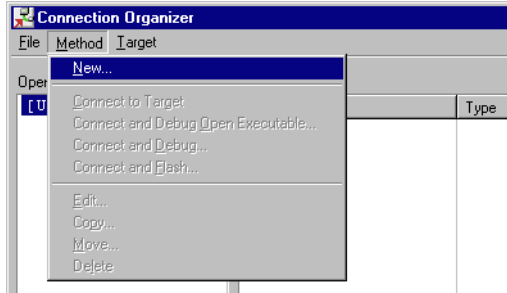

- The **Create a new Connection Method** will be opened. Enter a name for your configuration in the **Name** field and select **Custom** in the **Type** list. Confirm your choice with the **Create...** button.

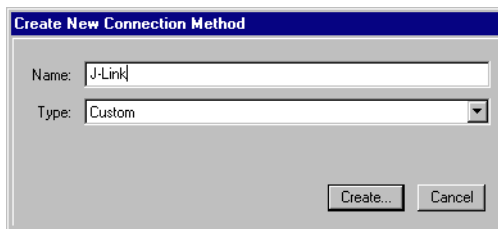

- The **Connection Editor** dialog will be opened. Enter **rdiserv** in the **Server** field and enter the following values in the **Arguments** field:

```
-config -dll <FullPathToJLinkDLLs>
```

Note that `JLinkRDI.dll` and `JLinkARM.dll` must be stored in the same directory. If the standard J-Link installation path or another path that includes spaces has been used, enclose the path in quotation marks.

Example:

```
-config -dll "C:\Program Files\SEGGER\JLinkARM_V350g\JLinkRDI.dll"
```

Refer to GHS manual "MULTI: Configuring Connections for ARM Targets", chapter "ARM Remote Debug Interface (rdiserv) Connections" for a complete list of possible arguments.

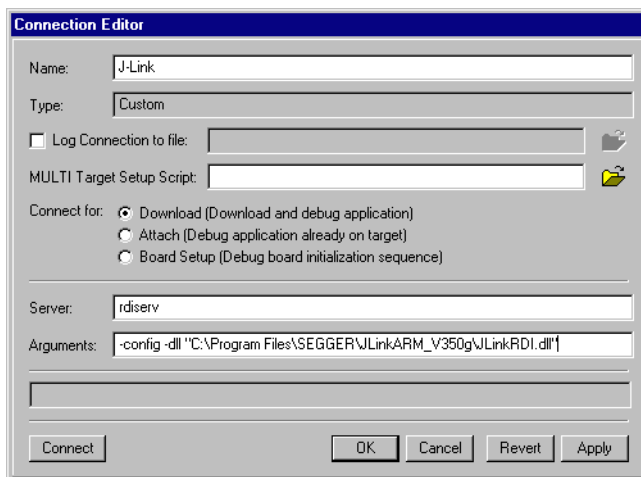

5. Confirm the choices by clicking the **Apply** button afterwards the **Connect** button.

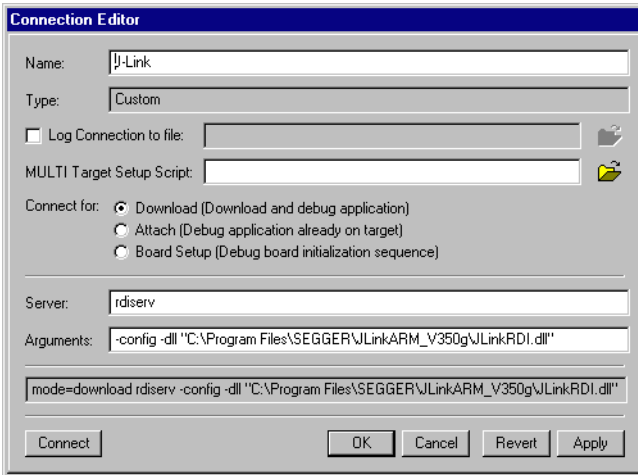

6. The **J-Link RDI Configuration** dialog will be opened. For more information about the generic setup of J-Link RDI, please refer to *Configuration* on page 226.
7. Click the **OK** button to connect to the target. Build the project and start the debugger. Note that at least one action (for example **step** or **run**) has to be performed in order to initiate the download of the application.

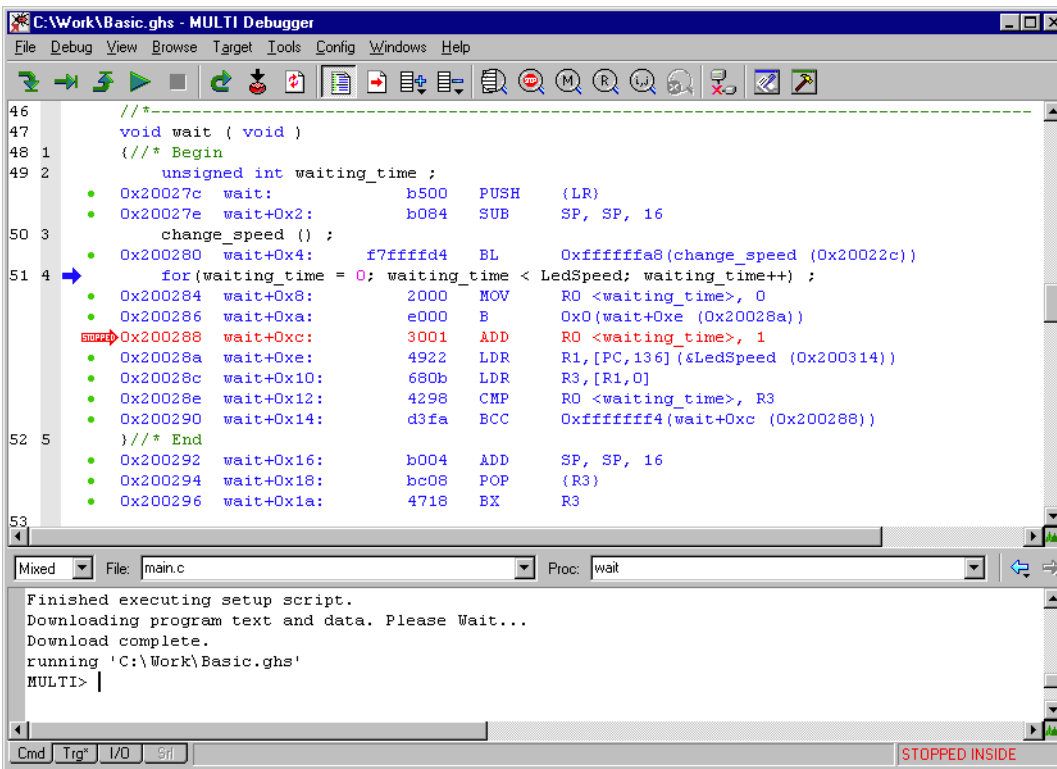

8.3.5 KEIL MDK (μ Vision IDE)

8.3.5.1 Software version

J-Link has been tested with KEIL MDK 3.34. There should be no problems with other versions of KEIL μ Vision. All screenshots are taken from MDK 3.34.

8.3.5.2 Configuring to use J-Link RDI

Start KEIL μ Vision and open the project.

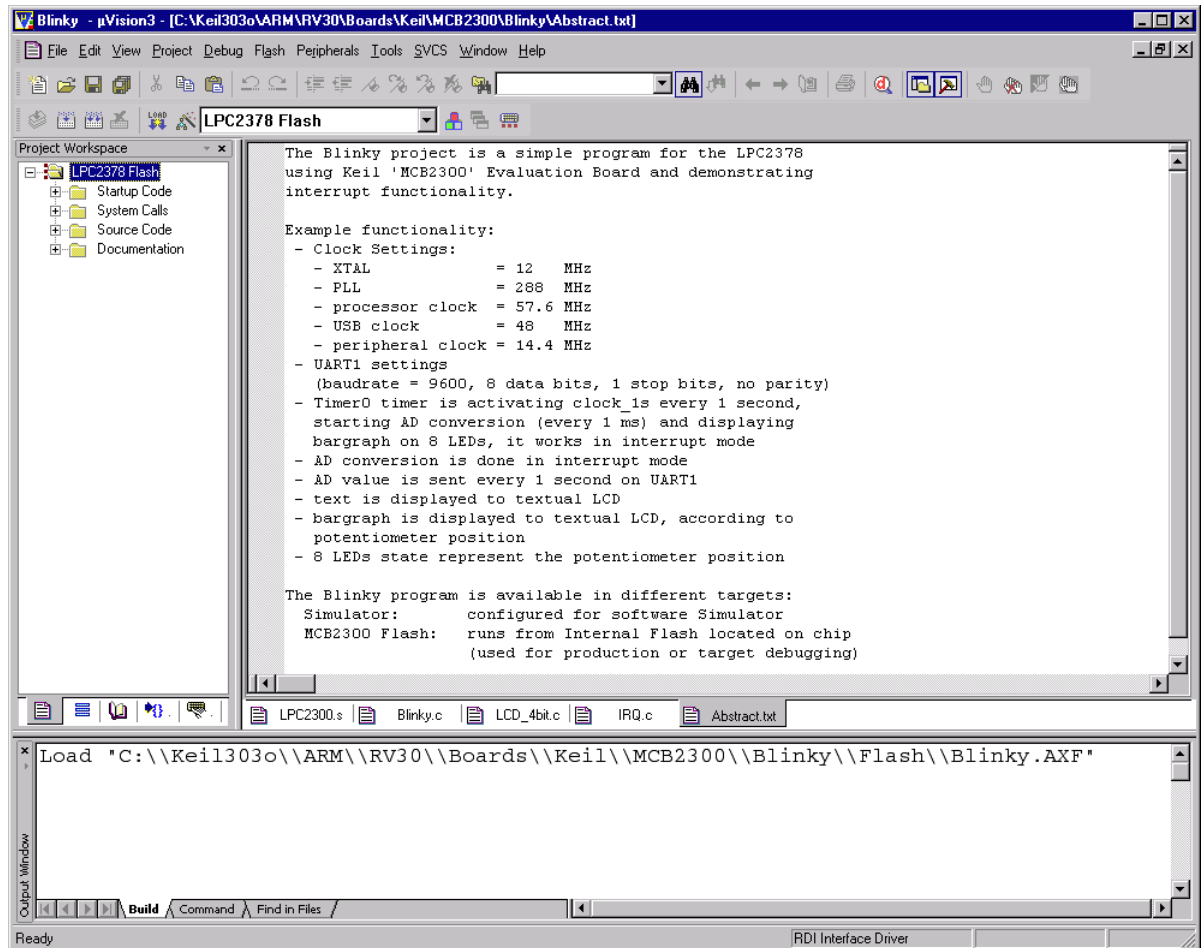

Select **Project | Options for Target** '<NameOfTarget>' to open the project options dialog and select the **Debug** tab.

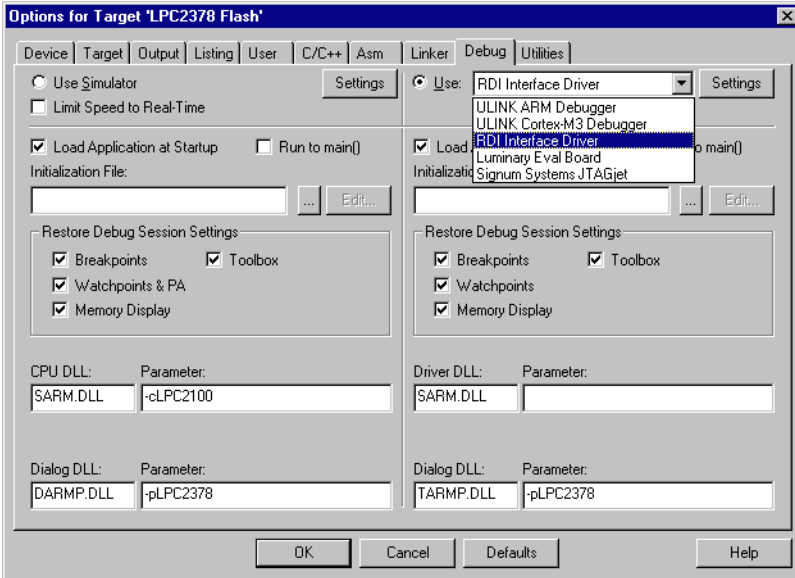

Choose **RDI Interface Driver** from the list as shown above and click the **Settings** button. Select the location of JLinkRDI.dll in **Browse for RDI Driver DLL** field, and click the **Configure RDI Driver** button.

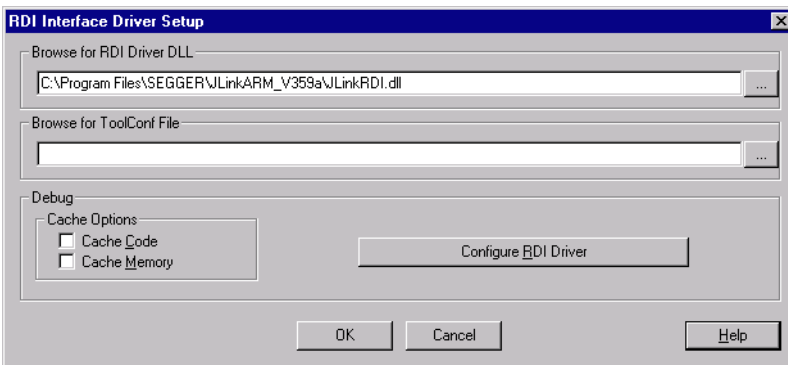

The J-Link RDI Configuration dialog will be opened. For more information about the generic setup of J-Link RDI, please refer to *Configuration* on page 226.

After finishing configuration, the project can be build (**Project | Build Target**) and the debugger can be started (**Debug | Start/Stop debug session**).

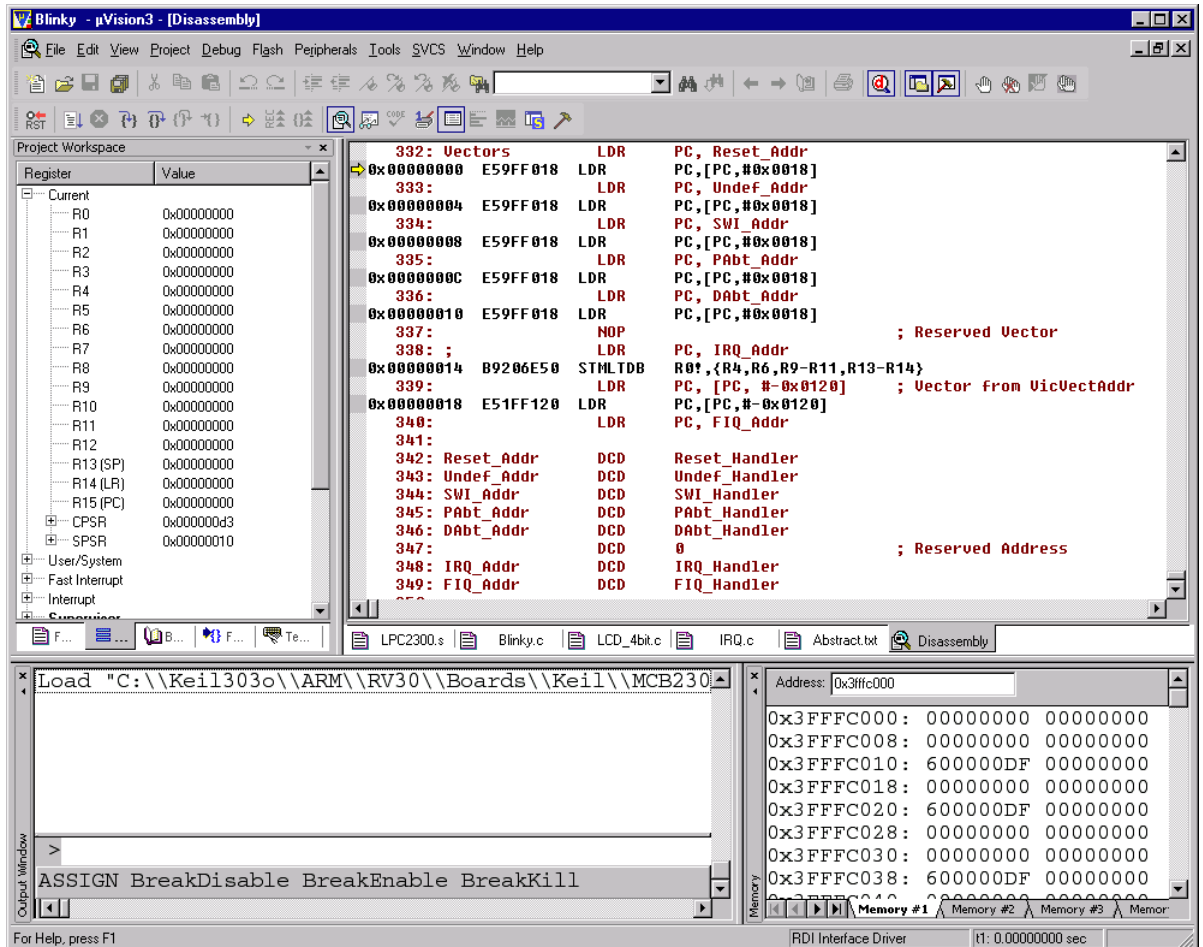

8.4 Configuration

This section describes the generic setup of J-Link RDI (same for all debuggers) using the J-Link RDI configuration dialog.

8.4.1 Configuration file JLinkRDI.ini

All settings are stored in the file `JLinkRDI.ini`. This file is located in the same directory as `JLinkRDI.dll`.

8.4.2 Using different configurations

It can be desirable to use different configurations for different targets. If this is the case, a new folder needs to be created and the `JLinkARM.dll` as well as the `JLinkRDI.dll` needs to be copied into it.

Project A needs to be configured to use `JLinkRDI.dll` A in the first folder, project B needs to be configured to use the DLL in the second folder. Both projects will use separate configuration files, stored in the same directory as the DLLs they are using.

If the debugger allows using a project-relative path (such as IAR EWARM: Use for example `$PROJ_DIR$\RDI\`), it can make sense to create the directory for the DLLs and configuration file in a subdirectory of the project.

8.4.3 Using multiple J-Links simultaneously

Same procedure as using different configurations. Each debugger session will use their own instance of the `JLinkRDI.dll`.

8.4.4 Configuration dialog

The configuration dialog consists of several tabs making the configuration of J-Link RDI very easy.

8.4.4.1 General tab



Connection to J-Link

This setting allows the user to configure how the DLL should connect to the J-Link. Some J-Link models also come with an Ethernet interface which allows to use an emulator remotely via TCP/IP connection.

License (J-Link RDI License management)

1. The **License** button opens the **J-Link RDI License management** dialog. J-Link RDI requires a valid license.

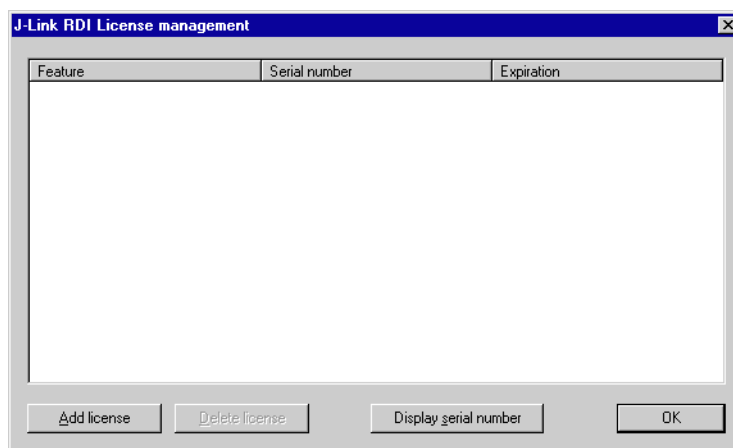

2. Click the **Add license** button and enter your license. Confirm your input by click-

ing the **OK** button.

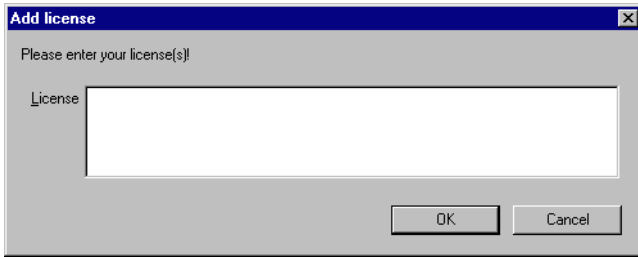

3. The J-Link RDI license is now added.

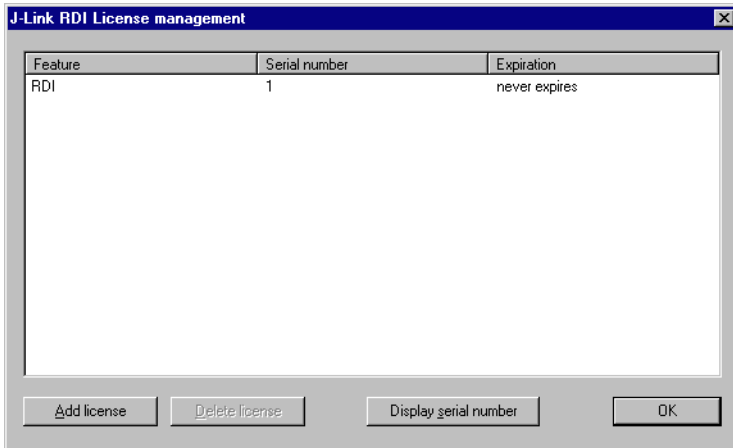

8.4.4.2 Init tab



Macro file

A macro file can be specified to load custom settings to configure J-Link RDI with advanced commands for special chips or operations. For example, a macro file can be used to initialize a target to use the PLL before the target application is downloaded, in order to speed up the download.

Comands in the macro file

Command	Description
SetJTAGSpeed(x);	Sets the JTAG speed, x = speed in kHz (0=Auto)
Delay(x);	Waits a given time, x = delay in milliseconds
Reset(x);	Resets the target, x = delay in milliseconds
Go();	Starts the ARM core
Halt();	Halts the ARM core
Read8(Addr);	Reads a 8/16/32 bit value, Addr = address to read (as hex value)
Read16(Addr);	
Read32(Addr);	
Verify8(Addr, Data);	Verifies a 8/16/32 bit value, Addr = address to verify (as hex value) Data = data to verify (as hex value)
Verify16(Addr, Data);	
Verify32(Addr, Data);	
Write8(Addr, Data);	Writes a 8/16/32 bit value, Addr = address to write (as hex value) Data = data to write (as hex value)
Write16(Addr, Data);	
Write32(Addr, Data);	
WriteVerify8(Addr, Data);	Writes and verifies a 8/16/32 bit value, Addr = address to write (as hex value) Data = data to write (as hex value)
WriteVerify16(Addr, Data);	
WriteVerify32(Addr, Data);	
WriteRegister(Reg, Data);	Writes a register
WriteJTAG_IR(Cmd);	Writes the JTAG instruction register
WriteJTAG_DR(nBits, Data);	Writes the JTAG data register

Table 8.2: Macro file commands

Example of macro file

```

/*****
*
*   Macro file for J-LINK RDI
*
*****
* File:    LPC2294.setup
* Purpose: Setup for Philips LPC2294 chip
*****
*/
SetJTAGSpeed(1000);
Reset(0);
Write32(0xE01FC040, 0x00000001); // Map User Flash into Vector area at (0-3f)
Write32(0xFFE00000, 0x20003CE3); // Setup CS0
Write32(0xE002C014, 0x0E6001E4); // Setup PINSEL2 Register
SetJTAGSpeed(2000);

```

8.4.4.3 JTAG tab

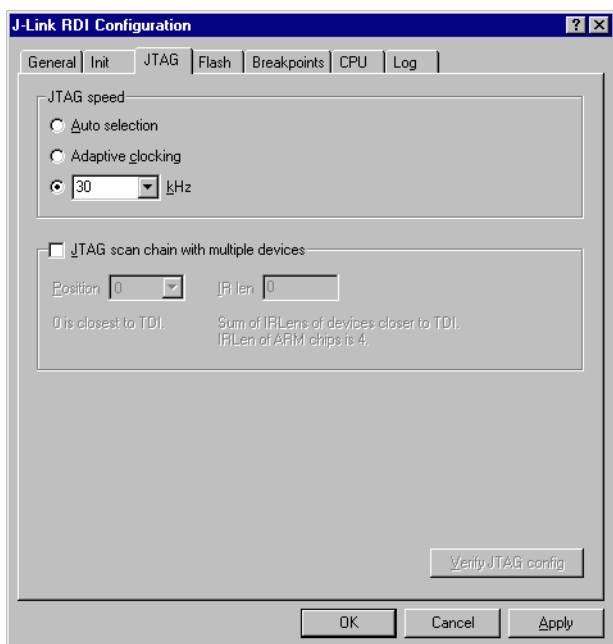

JTAG speed

This allows the selection of the JTAG speed. There are basically three types of speed settings (which are explained below):

- Fixed JTAG speed
- Automatic JTAG speed
- Adaptive clocking

For more information about the different speed settings supported by J-Link, please refer to *JTAG Speed* on page 144.

JTAG scan chain with multiple devices

The JTAG scan chain allows to specify the instruction register organization of the target system. This may be needed if there are more devices located on the target system than the ARM chip you want to access or if more than one target system is connected to one J-Link at once.

8.4.4.4 Flash tab

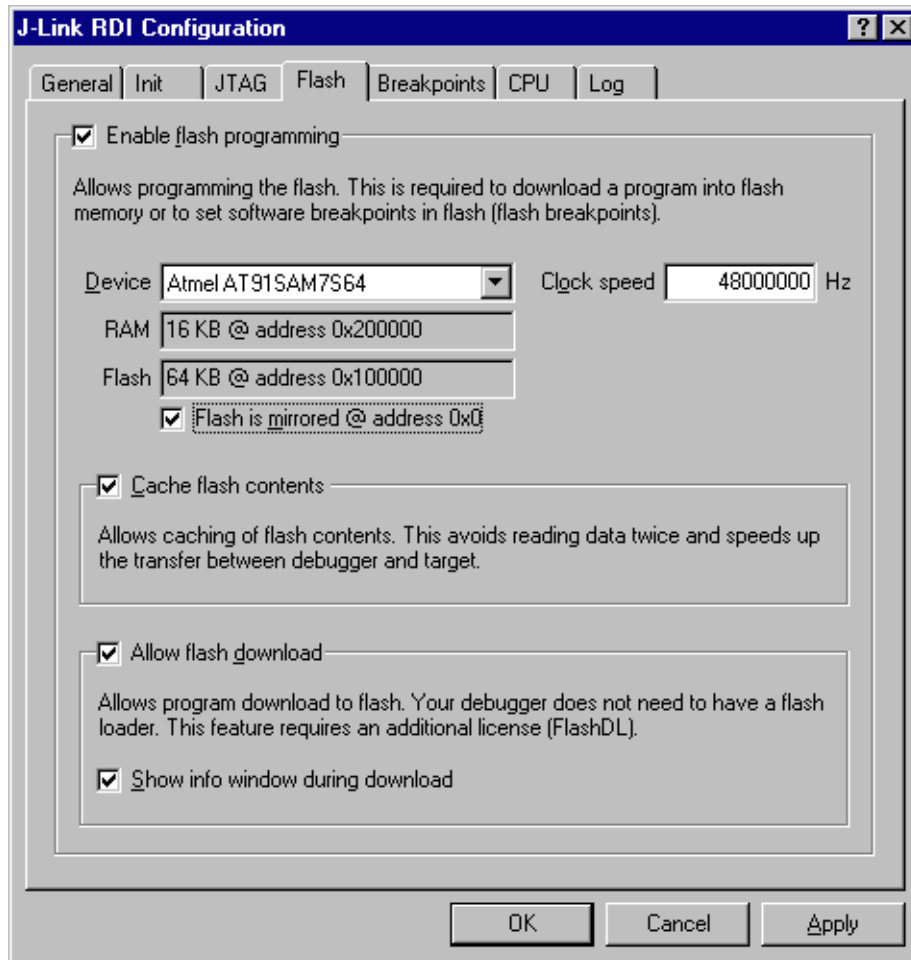

Enable flash programming

This checkbox enables flash programming. Flash programming is needed to use either flash download or to use flash breakpoints.

If flash programming is enabled you must select the correct flash memory and flash base address. Furthermore it is necessary for some chips to enter the correct CPU clock frequency.

Cache flash contents

If enabled, the flash contents is cached by the J-Link RDI software to avoid reading data twice and to speed up the transfer between debugger and target.

Allow flash download

This allows the J-Link RDI software to download program into flash. A small piece of code will be downloaded and executed in the target RAM which then programs the flash memory. This provides flash loading abilities even for debuggers without a build-in flash loader.

An info window can be shown during download displaying the current operation. Depending on your JTAG speed you may see the info window only very short.

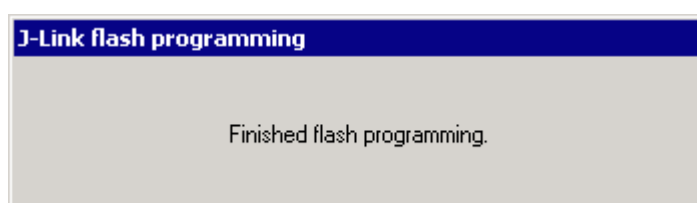

8.4.4.5 Breakpoints tab

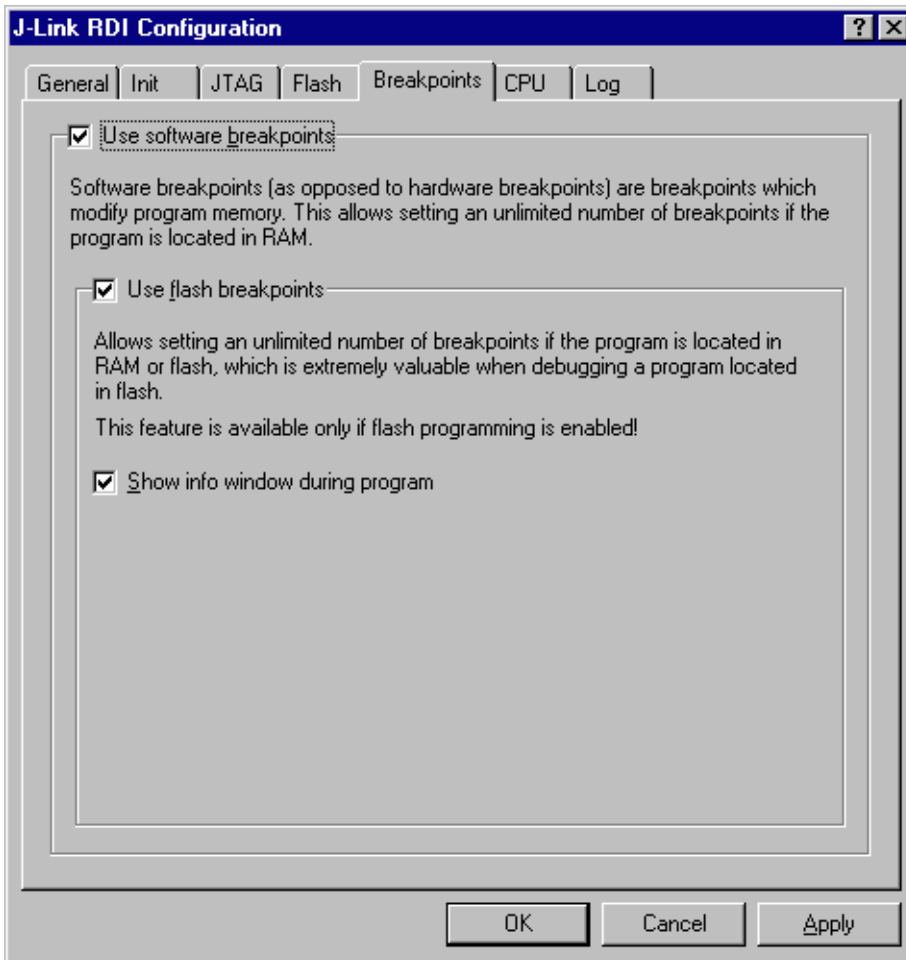

Use software breakpoints

This allows to set an unlimited number of breakpoints if the program is located in RAM by setting and resetting breakpoints according to program code.

Use flash breakpoints

This allows to set an unlimited number of breakpoints if the program is located either in RAM or in flash by setting and resetting breakpoints according to program code.

An info window can be displayed while flash breakpoints are used showing the current operation. Depending on your JTAG speed the info window may only hardly to be seen.

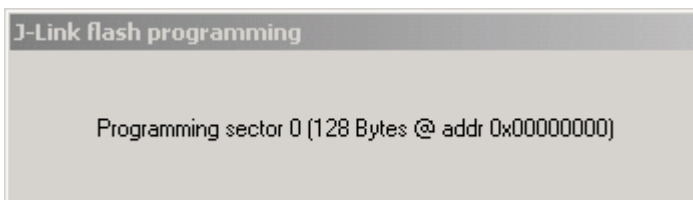

8.4.4.6 CPU tab

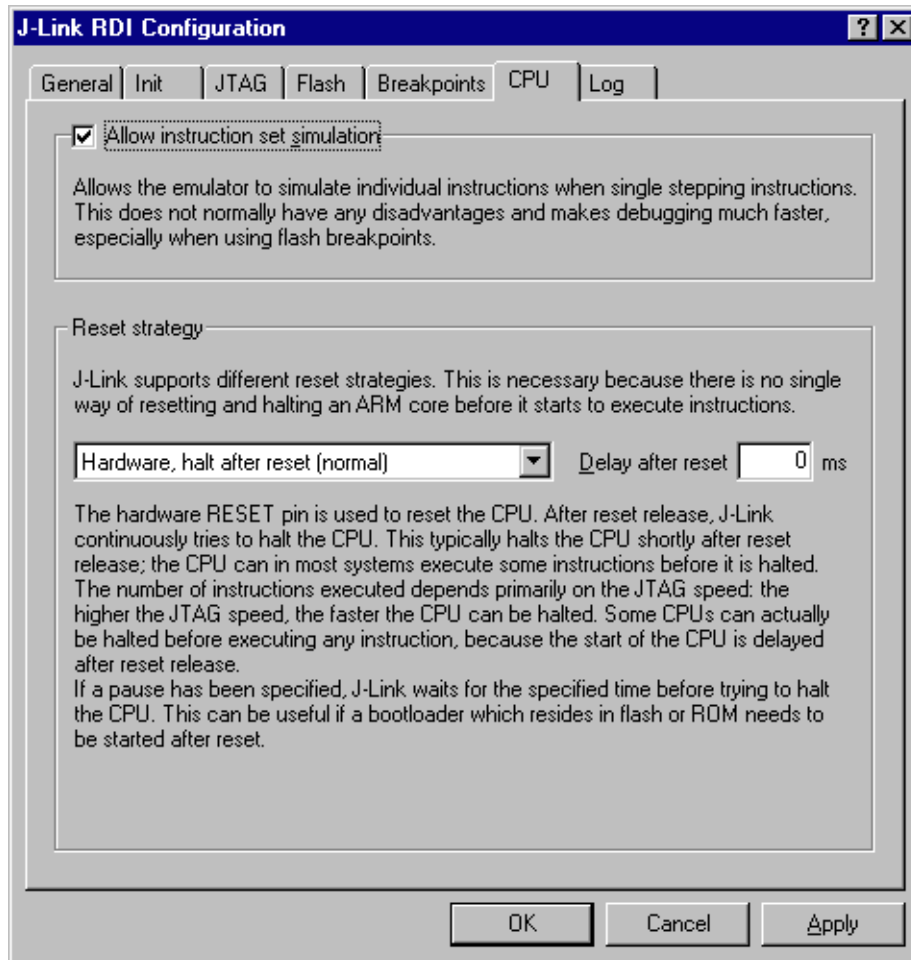

Instruction set simulation

This enables instruction set simulation which speeds up single stepping instructions especially when using flash breakpoints.

Reset strategy

This defines the behavior how J-Link RDI should handle resets called by software.

J-Link supports different reset strategies. This is necessary because there is no single way of resetting and halting an ARM core before it starts to execute instructions.

For more information about the different reset strategies which are supported by J-Link and why different reset strategies are necessary, please refer to *Reset strategies* on page 159.

8.4.4.7 Log tab

A log file can be generated for the J-Link DLL and for the J-Link RDI DLL. This log files may be useful for debugging and evaluating. They may help you to solve a problem yourself but is also needed by the support to help you with it.

Default path of the J-Link log file: `c:\JLinkARM.log`

Default path of the J-Link RDI log file: `c:\JLinkRDI.log`

Example of logfile content:

```

060:028 (0000) Logging started @ 2005-10-28 07:36
060:028 (0000) DLL Compiled: Oct  4 2005 09:14:54
060:031 (0026) ARM_SetMaxSpeed - Testing speed 3F0F0F0F 3F0F0F0F 3F0F0F0F 3F0F0F0F
3F0F0F0F 3F0F0F0F 3F0F0F0F 3F0F0F0F 3F0F0F0F 3F0F0F0F 3F0F0F0F 3F0F0F0FAuto JTAG
speed: 4000 kHz
060:059 (0000) ARM_SetEndian(ARM_ENDIAN_LITTLE)
060:060 (0000) ARM_SetEndian(ARM_ENDIAN_LITTLE)
060:060 (0000) ARM_ResetPullsRESET(ON)
060:060 (0116) ARM_Reset(): SpeedIsFixed == 0 -> JTAGSpeed = 30kHz >48> >2EF>
060:176 (0000) ARM_WriteIceReg(0x02,00000000)
060:177 (0016) ARM_WriteMem(FFFFFC20,0004) -- Data:  01 06 00 00 - Writing 0x4 bytes
@ 0xFFFFFC20 >1D7>
060:194 (0014) ARM_WriteMem(FFFFFC2C,0004) -- Data:  05 1C 19 00 - Writing 0x4 bytes
@ 0xFFFFFC2C >195>
060:208 (0015) ARM_WriteMem(FFFFFC30,0004) -- Data:  07 00 00 00 - Writing 0x4 bytes
@ 0xFFFFFC30 >195>
060:223 (0002) ARM_ReadMem (00000000,0004)JTAG speed: 4000 kHz -- Data:  0C 00 00 EA
060:225 (0001) ARM_WriteMem(00000000,0004) -- Data:  0D 00 00 EA - Writing 0x4 bytes
@ 0x00000000 >195>
060:226 (0001) ARM_ReadMem (00000000,0004) -- Data:  0C 00 00 EA
060:227 (0001) ARM_WriteMem(FFFFFFF0,0004) -- Data:  01 00 00 00 - Writing 0x4 bytes
@ 0xFFFFF000 >195>
060:228 (0001) ARM_ReadMem (FFFFFF240,0004) -- Data:  40 05 09 27
060:229 (0001) ARM_ReadMem (FFFFFF244,0004) -- Data:  00 00 00 00
060:230 (0001) ARM_ReadMem (FFFFFF6C,0004) -- Data:  10 01 00 00
060:232 (0000) ARM_WriteMem(FFFFFF124,0004) -- Data:  FF FF FF FF - Writing 0x4 bytes
@ 0xFFFFF124 >195>
060:232 (0001) ARM_ReadMem (FFFFFF130,0004) -- Data:  00 00 00 00
060:233 (0001) ARM_ReadMem (FFFFFF130,0004) -- Data:  00 00 00 00
060:234 (0001) ARM_ReadMem (FFFFFF130,0004) -- Data:  00 00 00 00
060:236 (0000) ARM_ReadMem (FFFFFF130,0004) -- Data:  00 00 00 00
060:237 (0000) ARM_ReadMem (FFFFFF130,0004) -- Data:  00 00 00 00
060:238 (0001) ARM_ReadMem (FFFFFF130,0004) -- Data:  00 00 00 00
060:239 (0001) ARM_ReadMem (FFFFFF130,0004) -- Data:  00 00 00 00
060:240 (0001) ARM_ReadMem (FFFFFF130,0004) -- Data:  00 00 00 00
060:241 (0001) ARM_WriteMem(FFFFFD44,0004) -- Data:  00 80 00 00 - Writing 0x4 bytes
@ 0xFFFFFD44 >195>
060:277 (0000) ARM_WriteMem(00000000,0178) -- Data:  0F 00 00 EA FE FF FF EA ...
060:277 (0000) ARM_WriteMem(000003C4,0020) -- Data:  01 00 00 00 02 00 00 00 ... -
Writing 0x178 bytes @ 0x00000000
060:277 (0000) ARM_WriteMem(000001CC,00F4) -- Data:  30 B5 15 48 01 68 82 68 ... -
Writing 0x20 bytes @ 0x000003C4
060:277 (0000) ARM_WriteMem(000002C0,0002) -- Data:  00 47
060:278 (0000) ARM_WriteMem(000002C4,0068) -- Data:  F0 B5 00 27 24 4C 34 4D ... -
Writing 0xF6 bytes @ 0x000001CC
060:278 (0000) ARM_WriteMem(0000032C,0002) -- Data:  00 47
060:278 (0000) ARM_WriteMem(00000330,0074) -- Data:  30 B5 00 24 A0 00 08 49 ... -
Writing 0x6A bytes @ 0x000002C4
060:278 (0000) ARM_WriteMem(000003B0,0014) -- Data:  00 00 00 00 0A 00 00 00 ... -
Writing 0x74 bytes @ 0x00000330
060:278 (0000) ARM_WriteMem(000003A4,000C) -- Data:  14 00 00 00 E4 03 00 00 ... -
Writing 0x14 bytes @ 0x000003B0
060:278 (0000) ARM_WriteMem(00000178,0054) -- Data:  12 4A 13 48 70 B4 81 B0 ... -
Writing 0xC bytes @ 0x000003A4
060:278 (0000) ARM_SetEndian(ARM_ENDIAN_LITTLE)
060:278 (0000) ARM_SetEndian(ARM_ENDIAN_LITTLE)
060:278 (0000) ARM_ResetPullsRESET(OFF)
060:278 (0009) ARM_Reset(): - Writing 0x54 bytes @ 0x00000178 >3E68>
060:287 (0001) ARM_Halt(): **** Warning: Chip has already been halted.
...

```

8.5 Semihosting

Semihosting is a mechanism for ARM targets to communicate input/output requests from application code to a host computer running a debugger.

It effectively allows the target to do disk operations and console I/O and is used primarily for flash loaders with ARM debuggers such as AXD.

8.5.1 Overview

Semihosting

Semihosting is a mechanism for ARM targets to communicate input/output requests from application code to a host computer running a debugger. This mechanism is used, to allow functions in the C library, such as `printf()` and `scanf()`, to use the screen and keyboard of the host rather than having a screen and keyboard on the target system.

This is useful because development hardware often does not have all the input and output facilities of the final system. Semihosting allows the host computer to provide these facilities.

Semihosting is also used for Disk I/O and flash programming; a flash loader uses semihosting to load the target program from disk.

Semihosting is implemented by a set of defined software interrupt (SWI) operations. The application invokes the appropriate SWI and the debug agent then handles the SWI exception. The debug agent provides the required communication with the host. In many cases, the semihosting SWI will be invoked by code within library functions.

Usage of semihosting

The application can also invoke the semihosting SWI directly. Refer to the C library descriptions in the ADS Compilers and Libraries Guide for more information on support for semihosting in the ARM C library.

Semihosting is not used by all tool chains; most modern tool chains (such as IAR) use different mechanisms to achieve the same goal.

Semihosting is used primarily by ARM's tool chain and debuggers, such as AXD.

Since semihosting has been used primarily by ARM, documents published by ARM are the best source of add. information.

For further information on semihosting and the C libraries, see the "C and C++ Libraries" chapter in ADS Compilers and Libraries Guide. Please see also the "Writing Code for ROM" chapter in ADS Developer Guide.

8.5.2 The SWI interface

The ARM and Thumb SWI instructions contain a field that encodes the SWI number used by the application code. This number can be decoded by the SWI handler in the system. See the chapter on exception handling in ADS Developer Guide for more information on SWI handlers.

Semihosting operations are requested using a single SWI number. This leaves the other SWI numbers available for use by the application or operating system. The SWI used for semihosting is:

0x123456 in ARM state
0xAB in Thumb state

The SWI number indicates to the debug agent that the SWI is a semihosting request. In order to distinguish between operations, the operation type is passed in r0. All other parameters are passed in a block that is pointed to by r1. The result is returned in r0, either as an explicit return value or as a pointer to a data block. Even if no result is returned, assume that r0 is corrupted.

The available semihosting operation numbers passed in r0 are allocated as follows:

0x00 to 0x31 These are used by ARM.

0x32 to 0xFF These are reserved for future use by ARM.

0x100 to 0x1FF Reserved for applications.

8.5.2.1 Changing the semihosting SWI numbers

It is strongly recommended that you do not change the semihosting SWI numbers 0x123456 (ARM) or 0xAB (Thumb). If you do so you must:

- change all the code in your system, including library code, to use the new SWI number
- reconfigure your debugger to use the new SWI number.

8.5.3 Implementation of semihosting in J-Link RDI

When using J-Link RDI in default configuration, semihosting is implemented as follows:

- A breakpoint / vector catch is set on the SWI vector.
- When this breakpoint is hit, J-Link RDI examines the SWI number.
- If the SWI is recognized as a semihosting SWI, J-Link RDI emulates it and transparently restarts execution of the application.
- If the SWI is not recognized as a semihosting SWI, J-Link RDI halts the processor and reports an error. (See *Unexpected / unhandled SWIs* on page 237)

8.5.3.1 DCC semihosting

J-Link RDI does not support using the debug communications channel for semihosting.

8.5.4 Semihosting with AXD

This semihosting mechanism can be disabled or changed by the following debugger internal variables:

\$semihosting_enabled

Set this variable to 0 to disable semihosting. If you are debugging an application running from ROM, this allows you to use an additional watchpoint unit.

Set this variable to 1 to enable semihosting. This is the default.

Set this variable to 2 to enable Debug Communications Channel (DCC) semihosting. The S bit in \$vector_catch has no effect unless semihosting is disabled.

\$semihosting_vector

This variable controls the location of the breakpoint set by J-Link RDI to detect a semihosted SWI. It is set to the SWI entry in the exception vector table () by default.

8.5.4.1 Using SWIs in your application

If your application requires semihosting as well as having its own SWI handler, set \$semihosting_vector to an address in your SWI handler. This address must point to an instruction that is only executed if your SWI handler has identified a call to a semihosting SWI. All registers must already have been restored to whatever values they had on entry to your SWI handler.

8.5.5 Unexpected / unhandled SWIs

When an unhandled SWI is detected by J-Link RDI, the message box below is shown.

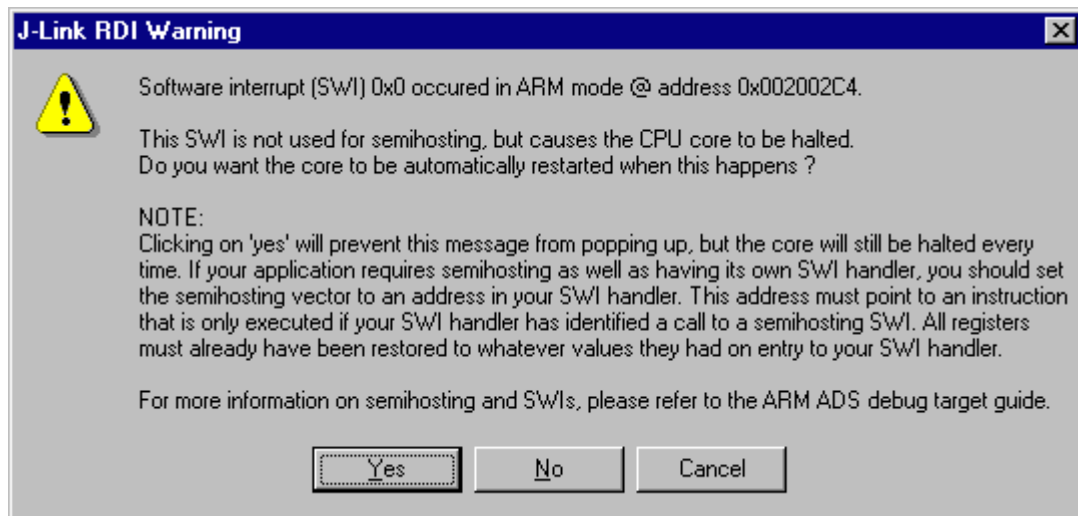

Chapter 9

Device specifics

This chapter describes for which devices some special handling is necessary to use them with J-Link.

9.1 Analog Devices

J-Link has been tested with the following MCUs from Analog Devices:

- AD7160
- ADuC7020x62
- ADuC7021x32
- ADuC7021x62
- ADuC7022x32
- ADuC7022x62
- ADuC7024x62
- ADuC7025x32
- ADuC7025x62
- ADuC7026x62
- ADuC7027x62
- ADuC7028x62
- ADuC7030
- ADuC7031
- ADuC7032
- ADuC7033
- ADuC7034
- ADuC7036
- ADuC7038
- ADuC7039
- ADuC7060
- ADuC7061
- ADuC7062
- ADuC7128
- ADuC7129
- ADuC7229x126
- ADuCRF02
- ADuCRF101

9.1.1 ADuC7xxx

9.1.1.1 Software reset

A special reset strategy has been implemented for Analog Devices ADuC7xxx MCUs. This special reset strategy is a software reset. "Software reset" means basically RESET pin is used to perform the reset, the reset is initiated by writing special function registers via software.

The software reset for Analog Devices ADuC7xxxx executes the following sequence:

- The CPU is halted
- A software reset sequence is downloaded to RAM
- A breakpoint at address 0 is set
- The software reset sequence is executed.

It is recommended to use this reset strategy. This sequence performs a reset of CPU and peripherals and halts the CPU before executing instructions of the user program. It is the recommended reset sequence for Analog Devices ADuC7xxx MCUs and works with these devices only.

This information is applicable to the following devices:

- Analog ADuC7020x62
- Analog ADuC7021x32
- Analog ADuC7021x62
- Analog ADuC7022x32
- Analog ADuC7022x62
- Analog ADuC7024x62
- Analog ADuC7025x32
- Analog ADuC7025x62

- Analog ADuC7026x62
- Analog ADuC7027x62
- Analog ADuC7030
- Analog ADuC7031
- Analog ADuC7032
- Analog ADuC7033
- Analog ADuC7128
- Analog ADuC7129
- Analog ADuC7229x126

9.2 ATMEL

J-Link has been tested with the following ATMEL devices:

- AT91SAM3A2C
- AT91SAM3A4C
- AT91SAM3A8C
- AT91SAM3N1A
- AT91SAM3N1B
- AT91SAM3N1C
- AT91SAM3N2A
- AT91SAM3N2B
- AT91SAM3N2C
- AT91SAM3N4A
- AT91SAM3N4B
- AT91SAM3N4C
- AT91SAM3S1A
- AT91SAM3S1B
- AT91SAM3S1C
- AT91SAM3S2A
- AT91SAM3S2B
- AT91SAM3S2C
- AT91SAM3S4A
- AT91SAM3S4B
- AT91SAM3S4C
- AT91SAM3U1C
- AT91SAM3U2C
- AT91SAM3U4C
- AT91SAM3U1E
- AT91SAM3U2E
- AT91SAM3U4E
- AT91SAM3X2C
- AT91SAM3X2E
- AT91SAM3X2G
- AT91SAM3X2H
- AT91SAM3X4C
- AT91SAM3X4E
- AT91SAM3X4G
- AT91SAM3X4H
- AT91SAM3X8C
- AT91SAM3X8E
- AT91SAM3X8G
- AT91SAM3X8H
- AT91SAM7A3
- AT91SAM7L64
- AT91SAM7L128
- AT91SAM7S16
- AT91SAM7S161
- AT91SAM7S32
- AT91SAM7S321
- AT91SAM7S64
- AT91SAM7S128
- AT91SAM7S256
- AT91SAM7S512
- AT91SAM7SE32
- AT91SAM7SE256
- AT91SAM7SE512
- AT91SAM7X128
- AT91SAM7X256
- AT91SAM7X512
- AT91SAM7XC128
- AT91SAM7XC256

- AT91SAM7XC512
- AT91SAM9XE128
- AT91SAM9XE256

9.2.1 AT91SAM7

9.2.1.1 Reset strategy

The reset pin of the device is per default disabled. This means that the reset strategies which rely on the reset pin (low pulse on reset) do not work per default. For this reason a special reset strategy has been made available.

It is recommended to use this reset strategy. This special reset strategy resets the peripherals by writing to the RSTC_CR register. Resetting the peripherals puts all peripherals in the defined reset state. This includes memory mapping register, which means that after reset flash is mapped to address 0. It is also possible to achieve the same effect by writing 0x4 to the RSTC_CR register located at address 0xfffffd00.

This information is applicable to the following devices:

- AT91SAM7S (all devices)
- AT91SAM7SE (all devices)
- AT91SAM7X (all devices)
- AT91SAM7XC (all devices)
- AT91SAM7A (all devices)

9.2.1.2 Memory mapping

Either flash or RAM can be mapped to address 0. After reset flash is mapped to address 0. In order to `majlink_supported_devices.html` RAM to address 0, a 1 can be written to the RSTC_CR register. Unfortunately, this remap register is a toggle register, which switches between RAM and flash with every time bit zero is written.

In order to achieve a defined mapping, there are two options:

1. Use the software reset described above.
2. Test if RAM is located at 0 using multiple read/write operations and testing the results.

Clearly 1. is the easiest solution and is recommended.

This information is applicable to the following devices:

- AT91SAM7S (all devices)
- AT91SAM7SE (all devices)
- AT91SAM7X (all devices)
- AT91SAM7XC (all devices)
- AT91SAM7A (all devices)

9.2.1.3 Recommended init sequence

In order to work with an ATMEL AT91SAM7 device, it has to be initialized. The following paragraph describes the steps of an init sequence. An example for different software tools, such as J-Link GDB Server, IAR Workbench and RDI, is given.

- Set JTAG speed to 30kHz
- Reset target
- Perform peripheral reset
- Disable watchdog
- Initialize PLL
- Use full JTAG speed

Samples

GDB Sample

```
# connect to the J-Link gdb server
target remote localhost:2331
monitor flash device = AT91SAM7S256
monitor flash download = 1
monitor flash breakpoints = 1
# Set JTAG speed to 30 kHz
monitor endian little
monitor speed 30
# Reset the target
monitor reset 8
monitor sleep 10
# Perform peripheral reset
monitor long 0xFFFFFD00 = 0xA5000004
monitor sleep 10
# Disable watchdog
monitor long 0xFFFFD44 = 0x00008000
monitor sleep 10
# Initialize PLL
monitor long 0xFFFFC20 = 0x00000601
monitor sleep 10
monitor long 0xFFFFC2C = 0x00480a0e
monitor sleep 10
monitor long 0xFFFFC30 = 0x00000007
monitor sleep 10
monitor long 0xFFFFF60 = 0x00480100
monitor sleep 100
monitor speed 12000
break main
load
continue
```

IAR Sample

```
/*
 *
 *      _Init()
 */
_Init() {
    __emulatorSpeed(30000);           // Set JTAG speed to 30 kHz
    __writeMemory32(0xA5000004, 0xFFFFFD00, "Memory"); // Perform peripheral reset
    __sleep(20000);
    __writeMemory32(0x00008000, 0xFFFFD44, "Memory"); // Disable Watchdog
    __sleep(20000);
    __writeMemory32(0x00000601, 0xFFFFC20, "Memory"); // PLL
    __sleep(20000);
    __writeMemory32(0x10191c05, 0xFFFFC2C, "Memory"); // PLL
    __sleep(20000);
    __writeMemory32(0x00000007, 0xFFFFC30, "Memory"); // PLL
    __sleep(20000);
    __writeMemory32(0x002f0100, 0xFFFFF60, "Memory"); // Set 1 wait state for
    __sleep(20000); // flash (2 cycles)
    __emulatorSpeed(12000000); // Use full JTAG speed
}

/*
 *
 *      execUserReset()
 */
execUserReset() {
    __message "execUserReset()";
    _Init();
}

/*
 *
 *      execUserPreload()
 */
execUserPreload() {
    __message "execUserPreload()";
    _Init();
}
```

RDI Sample

```

SetJTAGSpeed(30); // Set JTAG speed to 30 kHz
Reset(0, 0);
Write32(0xFFFFFD00, 0xA5000004); // Perform peripheral reset
Write32(0xFFFFFD44, 0x00008000); // Disable watchdog
Write32(0xFFFFFC20, 0x00000601); // Set PLL
Delay(200);
Write32(0xFFFFFC2C, 0x00191C05); // Set PLL and divider
Delay(200);
Write32(0xFFFFFC30, 0x00000007); // Select master clock and processor clock
Write32(0xFFFFF60, 0x00320300); // Set flash wait states
SetJTAGSpeed(12000);

```

9.2.2 AT91SAM9

9.2.2.1 JTAG settings

We recommend using adaptive clocking.

This information is applicable to the following devices:

- AT91RM9200
- AT91SAM9260
- AT91SAM9261
- AT91SAM9262
- AT91SAM9263

9.3 DSPGroup

J-Link has been tested with the following DSPGroup devices:

- DA56KLF

Currently, there are no specifics for these devices.

9.4 Ember

For more information, please refer to *Silicon Labs* on page 263.

9.5 Energy Micro

For more information, please refer to *Silicon Labs* on page 263.

9.6 Freescale

J-Link has been tested with the following Freescale devices:

- MAC7101
- MAC7106
- MAC7111
- MAC7112
- MAC7116
- MAC7121
- MAC7122
- MAC7126
- MAC7131
- MAC7136
- MAC7141
- MAC7142
- MK10DN512
- MK10DX128
- MK10DX256
- MK20DN512
- MK20DX128
- MK20DX256
- MK30DN512
- MK30DX128
- MK30DX256
- MK40N512
- MK40X128
- MK40X256
- MK50DN512
- MK50DX256
- MK50DN512
- MK50DX256
- MK51DX256
- MK51DN512
- MK51DX256
- MK51DN512
- MK51DN256
- MK51DN512
- MK52DN512
- MK53DN512
- MK53DX256
- MK60N256
- MK60N512
- MK60X256

9.6.1 Kinetis family

9.6.1.1 Unlocking

If your device has been locked by setting the MCU security status to "secure", and mass erase via debug interface is not disabled, J-Link is able to unlock your Kinetis K40/K60 device. The device can be unlocked by using the "unlock" command in J-Link Commander.

For more information regarding the MCU security status of the Kinetis devices, please refer to the user manual of your device.

9.6.1.2 Tracing

The first silicon of the Kinetis devices did not match the data setup and hold times which are necessary for ETM-Trace. On these devices, a low drive strength should be configured for the trace clock pin in order to match the timing requirements.

On later silicons, this has been corrected. This bug applies to all devices with mask 0M33Z from the 100MHz series.

The J-Link software and documentation package comes with a sample project for the Kinetis K40 and K60 devices which is pre-configured for the TWR-40 and TWR-60 eval boards and ETM / ETB Trace. This sample project can be found at `\Samples\JLink\Projects`.

9.6.1.3 Data flash support

Some devices of the Kinetis family have an additional area called FlexNVM, which can be configured as data flash. The size of the FlexNVM to be used as data flash is configurable and needs to be configured first, before this area can be used as data flash.

The sample below shows how to configure the FlexNVM area to be used as data flash out of the target application.

For J-Flash there are also projects that are already preconfigured to configure the data flash size of a Kinetis device. The projects can be found at `$JLINK_INST_DIR$\Samples\JFlash\ProjectFiles`. One of these sample projects is the `MK40DX256xxx10_ConfigureDataFlash.jflash`.

For more information about how configuration of the data flash works, please refer to the appropriate user manual of the device.

Configure FlexNVM area as data flash

The following sample configures the data flash size of Kinetis device. It is created for a MK40DX256xxx10 device. The sequence is almost the same for all Kinetis devices only the lines which configure size of the data flash may be modified. In this sample the data flash is set to max size. EEPROM size is set to 0 bytes.

```
#define FSTAT    (*(volatile unsigned char*)(0x40020000 + 0x00))
#define FCCOB0  (*(volatile unsigned char*)(0x40020000 + 0x07))
#define FCCOB1  (*(volatile unsigned char*)(0x40020000 + 0x06))
#define FCCOB2  (*(volatile unsigned char*)(0x40020000 + 0x05))
#define FCCOB3  (*(volatile unsigned char*)(0x40020000 + 0x04))
#define FCCOB4  (*(volatile unsigned char*)(0x40020000 + 0x0B))
#define FCCOB5  (*(volatile unsigned char*)(0x40020000 + 0x0A))
#define FCCOB6  (*(volatile unsigned char*)(0x40020000 + 0x09))
#define FCCOB7  (*(volatile unsigned char*)(0x40020000 + 0x08))
#define FCCOB8  (*(volatile unsigned char*)(0x40020000 + 0x0F))

void ConfigureDataFlash(void);

*****
*
*       ConfigureDataFlash
*
*  Notes
*  Needs to be located in RAM since it performs flash operations
*  which make instruction fetching from flash temporarily not possible.
*/
void ConfigureDataFlash(void) {
    unsigned char v;

    //
    // Read out current configuration first
    //
    FSTAT = 0x70;           // Clear error flags in status register
    FCCOB0 = 0x03;         // Read resource
    FCCOB1 = 0x80;         // Read from data flash IFR area with offset 0xFC (0x8000FC)
    FCCOB2 = 0x00;
    FCCOB3 = 0xFC;
    FCCOB8 = 0x00;         // Select IFR area to be read
    FSTAT = 0x80;         // Start command execution
    while((FSTAT & 0x80) == 0); // Wait until flash controller has finished
    //
}
```

```
// Check current data flash & EEPROM config
//
v = FCCOB6;                // IFR offset 0xFD
if (v != 0xFF) {          // EEPROM data set size already configured?
    return;
}
v = FCCOB7;                // IFR offset 0xFC
if (v != 0xFF) {          // FlexNVM partition code already configured?
    return;
}
//
// Configure EEPROM size and data flash size
// via the program partition command
//
FCCOB0 = 0x80;            // Program partition
FCCOB4 = 0x3F;            // EEPROM data size code: 0 KB EEPROM
FCCOB5 = 0x00;            // FlexNVM partition code: 256 KB data flash
FSTAT = 0x80;            // Start command execution
while((FSTAT & 0x80) == 0); // Wait until flash controller has finished
}
```

9.7 Fujitsu

J-Link has been tested with the following Fujitsu devices:

- MB9AF102N
- MB9AF102R
- MB9AF104N
- MB9AF104R
- MB9BF104N
- MB9BF104R
- MB9BF105N
- MB9BF105R
- MB9BF106N
- MB9BF106R
- MB9BF304N
- MB9BF304R
- MB9BF305N
- MB9BF305R
- MB9BF306N
- MB9BF306R
- MB9BF404N
- MB9BF404R
- MB9BF405N
- MB9BF405R
- MB9BF406N
- MB9BF406R
- MB9BF504N
- MB9BF504R
- MB9BF505N
- MB9BF505R
- MB9BF506N
- MB9BF506R

Currently, there are no specifics for these devices.

9.8 Itron

J-Link has been tested with the following Itron devices:

- TRIFECTA

Currently, there are no specifics for these devices.

9.9 Infineon

J-Link has been tested with the following Infineon devices:

- UMF1110
- UMF1120
- UMF5110
- UMF5120
- XMC1100-T016F00xx
- XMC1100-T038F00xx
- XMC1100-T038F0xxx
- XMC1201-T028F0xxx
- XMC1201-T038F0xxx
- XMC1202-T016X00xx
- XMC1202-T028X00xx
- XMC1202-T038X00xx
- XMC1203-T016X0xxx
- XMC1301-T016F00xx
- XMC1302-T038X0xxx
- XMC4100-128
- XMC4104-128
- XMC4104-64
- XMC4200-256
- XMC4400-256
- XMC4400-512
- XMC4402-256
- XMC4500-1024
- XMC4500-768
- XMC4502
- XMC4504

Currently, there are no specifics for these devices.

9.10 Luminary Micro

J-Link has been tested with the following Luminary Micro devices:

- LM3S101
- LM3S102
- LM3S301
- LM3S310
- LM3S315
- LM3S316
- LM3S317
- LM3S328
- LM3S601
- LM3S610
- LM3S611
- LM3S612
- LM3S613
- LM3S615
- LM3S617
- LM3S618
- LM3S628
- LM3S801
- LM3S811
- LM3S812
- LM3S815
- LM3S817
- LM3S818
- LM3S828
- LM3S2110
- LM3S2139
- LM3S2410
- LM3S2412
- LM3S2432
- LM3S2533
- LM3S2620
- LM3S2637
- LM3S2651
- LM3S2730
- LM3S2739
- LM3S2939
- LM3S2948
- LM3S2950
- LM3S2965
- LM3S6100
- LM3S6110
- LM3S6420
- LM3S6422
- LM3S6432
- LM3S6610
- LM3S6633
- LM3S6637
- LM3S6730
- LM3S6938
- LM3S6952
- LM3S6965

9.10.1 Unlocking LM3Sxxx devices

If your device has been "locked" accidentally (e.g. by bad application code in flash which mis-configures the PLL) and J-Link can not identify it anymore, there is a special unlock sequence which erases the flash memory of the device, even if it can not be identified. This unlock sequence can be send to the target, by using the "unlock" command in J-Link Commander.

9.11 NXP

J-Link has been tested with the following NXP devices:

- LPC1111
- LPC1113
- LPC1311
- LPC1313
- LPC1342
- LPC1343
- LPC1751
- LPC1751
- LPC1752
- LPC1754
- LPC1756
- LPC1758
- LPC1764
- LPC1765
- LPC1766
- LPC1768
- LPC2101
- LPC2102
- LPC2103
- LPC2104
- LPC2105
- LPC2106
- LPC2109
- LPC2114
- LPC2119
- LPC2124
- LPC2129
- LPC2131
- LPC2132
- LPC2134
- LPC2136
- LPC2138
- LPC2141
- LPC2142
- LPC2144
- LPC2146
- LPC2148
- LPC2194
- LPC2212
- LPC2214
- LPC2292
- LPC2294
- LPC2364
- LPC2366
- LPC2368
- LPC2378
- LPC2468
- LPC2478
- LPC2880
- LPC2888
- LPC2917
- LPC2919
- LPC2927
- LPC2929
- PCF87750
- SJA2010
- SJA2510

9.11.1 LPC ARM7-based devices

9.11.1.1 Fast GPIO bug

The values of the fast GPIO registers can not be read direct via JTAG from a debugger. The direct access to the registers corrupts the returned values. This means that the values in the fast GPIO registers normally can not be checked or changed from a debugger.

Solution / Workaround

J-Link supports command strings which can be used to read a memory area indirect. Indirectly reading means that a small code snippet will be written into RAM of the target device, which reads and transfers the data of the specified memory area to the debugger. Indirectly reading solves the fast GPIO problem, because only direct register access corrupts the register contents.

Define a 256 byte aligned area in RAM of the LPC target device with the J-Link command `map ram` and define afterwards the memory area which should be read indirect with the command `map indirectread` to use the indirectly reading feature of J-Link. Note that the data in the defined RAM area is saved and will be restored after using the RAM area.

This information is applicable to the following devices:

- LPC2101
- LPC2102
- LPC2103
- LPC213x/01
- LPC214x (all devices)
- LPC23xx (all devices)
- LPC24xx (all devices)

Example

J-Link commands line options can be used for example with the C-SPY debugger of the IAR Embedded Workbench. Open the **Project options** dialog and select **Debugger**. Select **Use command line options** in the **Extra Options** tap and enter in the textfield `--jlink_exec_command "map ram 0x40000000-0x40003fff; map indirectread 0x3fffc000-0x3fffcfff; map exclude 0x3fffd000-0x3ffffff;"` as shown in the screenshot below.

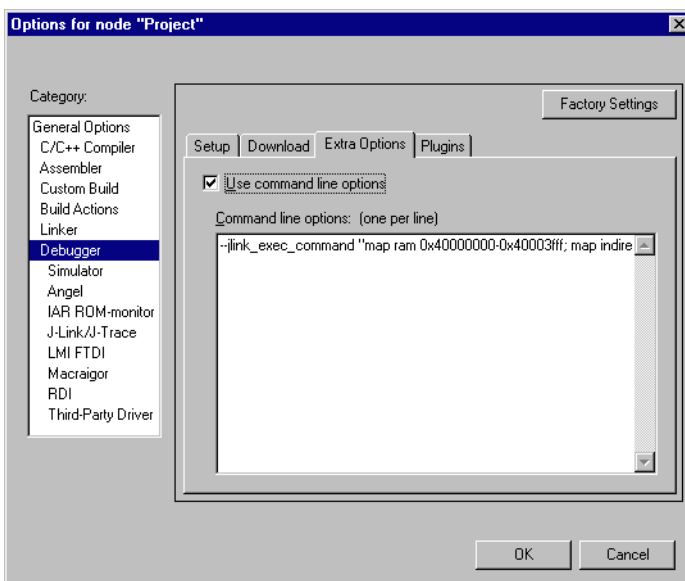

With these additional commands are the values of the fast GPIO registers in the C-SPY debugger correct and can be used for debugging. For more information about J-Link command line options refer to subchapter *Command strings* on page 176.

9.11.1.2 RDI

J-Link comes with a device-based RDI license for NXP LPC21xx-LPC24xx devices. This means the J-Link RDI software can be used with LPC21xx-LPC24xx devices free of charge. For more information about device-based licenses, please refer to *License types* on page 49.

9.11.2 Reset (Cortex-M3 based devices)

For Cortex-M3 based NXP LPC devices the reset itself does not differ from the one for other Cortex-M3 based devices: After the device has been reset, the core is halted before any instruction is performed. For the Cortex-M3 based LPC devices this means the CPU is halted before the bootloader which is mapped at address 0 after reset.

The user should write the memmap register after reset, to ensure that user flash is mapped at address 0. Moreover, the user have to correct the Stack pointer (R13) and the PC (R15) manually, after reset in order to debug the application.

9.11.3 LPC288x flash programming

In order to use the LPC288x devices in combination with the J-Link flash download feature, the application you are trying to debug, should be linked to the original flash @ addr 0x10400000. Otherwise it is user's responsibility to ensure that flash is re-mapped to 0x0 in order to debug the application from addr 0x0.

9.11.4 LPC43xx:

All devices of the LPC43xx are dual core devices (One Cortex-M4 core and one Cortex-M0 core). For these devices, a J-Link script file is needed (exact file depends on if the Cortex-M4 or the Cortex-M0 shall be debugged) in order to guarantee proper functionality.

Script file can be found at `$JLINK_INST_DIR$\Samples\JLink\Scripts`

For more information about how to use J-Link script files, please refer to *Executing J-Link script files* on page 174.

9.12 OKI

J-Link has been tested with the following OKI devices:

- ML67Q4002
- ML67Q4003
- ML67Q4050
- ML67Q4051
- ML67Q4060
- ML67Q4061

Currently, there are no specifics for these devices.

9.13 Renesas

J-Link has been tested with the following Renesas devices:

- R5F56104
- R5F56106
- R5F56107
- R5F56108
- R5F56216
- R5F56217
- R5F56218
- R5F562N7
- R5F562N8
- R5F562T6
- R5F562T7
- R5F562TA

Currently, there are no specifics for these devices.

9.14 Samsung

J-Link has been tested with the following Samsung devices:

- S3FN60D

9.14.1 S3FN60D

On the S3FN60D the watchdog may be running after reset (depends on the content of the smart option bytes at addr. 0xC0). The watchdog keeps counting even if the CPU is in debug mode (e.g. halted). So, please do not use the watchdog when debugging to avoid unexpected behavior of the target application. A special reset strategy has been implemented for this device which disables the watchdog right after a reset has been performed. We recommend to use this reset strategy when debugging a Samsung S3FN60D device.

9.15 Silicon Labs

J-Link has been tested with the following Silicon Labs devices:

- EFM32G200F16
- EFM32G200F32
- EFM32G200F64
- EFM32G210F128
- EFM32G230F32
- EFM32G230F64
- EFM32G230F128
- EFM32G280F32
- EFM32G280F64
- EFM32G280F128
- EFM32G290F32
- EFM32G290F64
- EFM32G290F128
- EFM32G840F32
- EFM32G840F64
- EFM32G840F128
- EFM32G880F32
- EFM32G880F64
- EFM32G880F128
- EFM32G890F32
- EFM32G890F64
- EFM32G890F128
- EFM32TG108F4
- EFM32TG108F8
- EFM32TG108F16
- EFM32TG108F32
- EFM32TG110F4
- EFM32TG110F8
- EFM32TG110F16
- EFM32TG110F32
- EFM32TG210F8
- EFM32TG210F16
- EFM32TG210F32
- EFM32TG230F8
- EFM32TG230F16
- EFM32TG230F32
- EFM32TG840F8
- EFM32TG840F16
- EFM32TG840F32
- EM351
- EM357

9.15.1 EFM32 series devices

9.15.1.1 SWO

Usually, the SWO output frequency of a device is directly dependent on the CPU speed. The SWO speed is calculated as: $\langle \text{CPUFreq} \rangle / n$. On the EFM32 series this is not the case:

The SWO related units (ITM, TPIU, ...) are chip-internally wired to a fixed 14 MHz clock (AUXHFRCO).

This will cause the auto-detection of J-Link to not work by default for these devices, if the CPU is running at a different speed than AUXHFRCO. All utilities that use SWO speed auto-detection, like the J-Link SWOViewer, need to be told that the CPU is running at 14 MHz, to make SWO speed auto-detection to work, no matter what speed the CPU is really running at.

9.16 ST Microelectronics

J-Link has been tested with the following ST Microelectronics devices:

- STR710FZ1
- STR710FZ2
- STR711FR0
- STR711FR1
- STR711FR2
- STR712FR0
- STR712FR1
- STR712FR2
- STR715FR0
- STR730FZ1
- STR730FZ2
- STR731FV0
- STR731FV1
- STR731FV2
- STR735FZ1
- STR735FZ2
- STR736FV0
- STR736FV1
- STR736FV2
- STR750FV0
- STR750FV1
- STR750FV2
- STR751FR0
- STR751FR1
- STR751FR2
- STR752FR0
- STR752FR1
- STR752FR2
- STR755FR0
- STR755FR1
- STR755FR2
- STR755FV0
- STR755FV1
- STR755FV2
- STR911FM32
- STR911FM44
- STR911FW32
- STR911FW44
- STR912FM32
- STR912FM44
- STR912FW32
- STR912FW44
- STM32F101C6
- STM32F101C8
- STM32F101R6
- STM32F101R8
- STM32F101RB
- STM32F101V8
- STM32F101VB
- STM32F103C6
- STM32F103C8
- STM32F103R6
- STM32F103R8
- STM32F103RB
- STM32F103V8
- STM32F103VB

9.16.1 STR91x

9.16.1.1 JTAG settings

These device are ARM966E-S based. We recommend to use adaptive clocking for these devices.

9.16.1.2 Unlocking

The devices have 3 TAP controllers built-in. When starting `J-Link.exe`, it reports 3 JTAG devices. A special tool, J-Link STR9 Commander (`JLinkSTR91x.exe`) is available to directly access the flash controller of the device. This tool can be used to erase the flash of the controller even if a program is in flash which causes the ARM core to stall. For more information about the J-Link STR9 Commander, please refer to *J-Link STR91x Commander (Command line tool)* on page 113.

When starting the STR91x commander, a command sequence will be performed which brings MCU into Turbo Mode.

"While enabling the Turbo Mode, a dedicated test mode signal is set and controls the GPIOs in output. The IOs are maintained in this state until a next JTAG instruction is send." (ST Microelectronics)

Enabling Turbo Mode is necessary to guarantee proper function of all commands in the STR91x Commander.

9.16.1.3 Switching the boot bank

The bootbank of the STR91x devices can be switched by using the J-Link STR9 Commander which is part of the J-Link software and documentation package. For more information about the J-Link STR9 Commander, please refer to *J-Link STR91x Commander (Command line tool)* on page 113.

9.16.2 STM32F10xxx

These device are Cortex-M3 based.
All devices of this family are supported by J-Link.

9.16.2.1 ETM init

The following sequence can be used to prepare STM32F10xxx devices for 4-bit ETM tracing:

```
int v;
//
// DBGMCU_CR, enable trace I/O and configure pins for 4-bit trace.
//
v = *((volatile int *) (0xE0042004));
v &= ~(7 << 5); // Preserve all bits except the trace pin configuration
v |= (7 << 5); // Enable trace I/O and configure pins for 4-bit trace
*((volatile int *) (0xE0042004)) = v;
```

9.16.2.2 Option byte programming

J-Flash supports programming of the option bytes for STM32 devices. In order to program the option bytes simply choose the appropriate Device, which allows option byte programming, in the CPU settings tab (e.g. **STM32F103ZE (allow opt. bytes)**). J-Flash will allow programming a virtual 16-byte sector at address

0x06000000 which represents the 8 option bytes and their complements. You do not have to care about the option bytes' complements since they are computed automatically. The following table describes the structure of the option bytes sector

Address	[31:24]	[23:16]	[15:8]	[7:0]
0x06000000	complement	Option byte 1	complement	Option byte 0
0x06000004	complement	Option byte 3	complement	Option byte 2
0x06000008	complement	Option byte 5	complement	Option byte 4
0x0600000C	complement	Option byte 7	complement	Option byte 6

Table 9.1: Option bytes sector description

Note: Writing a value of 0xFF inside option byte 0 will read-protect the STM32. In order to keep the device unprotected you have to write the key value 0xA5 into option byte 0.

Note: The address 0x06000000 is a virtual address only. The option bytes are originally located at address 0x1FFFF800. The remap from 0x06000000 to 0x1FFFF800 is done automatically by J-Flash.

Example

To program the option bytes 2 and 3 with the values 0xAA and 0xBB but leave the device unprotected your option byte sector (at addr 0x06000000) should look like as follows:

Address	[31:24]	[23:16]	[15:8]	[7:0]
0x06000000	0x00	0xFF	0x5A	0xA5
0x06000004	0x44	0xBB	0x55	0xAA
0x06000008	0x00	0xFF	0x00	0xFF
0x0600000C	0x00	0xFF	0x00	0xFF

Table 9.2: Option bytes programming example

For a detailed description of each option byte, please refer to *ST programming manual PM0042, section "Option byte description"*.

9.16.2.3 Securing/unsecuring the device

The user area internal flash of the STM32 devices can be protected (secured) against read by untrusted code. The J-Flash software allows securing a STM32F10x device. For more information about J-Flash, please refer to *UM08003, J-Flash User Guide*. In order to unsecure a read-protected STM32F10x device, SEGGER offers two software components:

- J-Flash
- J-Link STM32 Commander (command line utility)

For more information about J-Flash, please refer to *UM08003, J-Flash User Guide*. For more information about the J-Link STM32 Commander, please refer to *J-Link STM32 Unlock (Command line tool)* on page 114.

Note: Unsecuring a secured device will cause a mass-erase of the internal flash memory.

9.16.2.4 Hardware watchdog

The hardware watchdog of a STM32F10x device can be enabled by programming the option bytes. If the hardware watchdog is enabled the device is reset periodically if the watchdog timer is not refreshed and reaches 0. If the hardware watchdog is enabled by an application which is located in flash and which does not refresh the watchdog timer, the device can not be debugged anymore.

Disabling the hardware watchdog

In order to disable the hardware watchdog the option bytes have to be re-programmed. SEGGER offers a free command line tool which reprograms the option bytes in order to disable the hardware watchdog. For more information about the STM32 commander, please refer to *J-Link STM32 Unlock (Command line tool)* on page 114.

9.16.2.5 Debugging with software watchdog enabled

If the device shall be debugged with one of the software watchdogs (independent watchdog / window watchdog) enabled, there is an additional init step necessary to make the watchdog counter stop when the CPU is halted by the debugger. This is configured in the DBGMCU_CR register. The following sequence can be used to enable debugging with software watchdogs enabled:

```
//
// Configure both watchdog timers to be halted if the CPU is halted by the debugger
//
*((volatile int *) (0xE0042004)) |= (1 << 8) | (1 << 9);
```

9.16.3 STM32F2xxx

These devices are Cortex-M3 based.
All devices of this family are supported by J-Link.

9.16.3.1 ETM init

The following sequence can be used to prepare STM32F2xxx devices for 4-bit ETM tracing:

```
int v;
//
// Enable GPIOE clock
//
*((volatile int *) (0x40023830)) = 0x00000010;
//
// Assign trace pins to alternate function in order
// to make them usable as trace pins
// PE2: Trace clock
// PE3: TRACE_D0
// PE4: TRACE_D1
// PE5: TRACE_D2
// PE6: TRACE_D3
//
*((volatile int *) (0x40021000)) = 0x00002AA0;
//
// DBGMCU_CR, enable trace I/O and configure pins for 4-bit trace.
//
v = *((volatile int *) (0xE0042004));
v &= ~(7 << 5); // Preserve all bits except the trace pin configuration
v |= (7 << 5); // Enable trace I/O and configure pins for 4-bit trace
*((volatile int *) (0xE0042004)) = v;
```

9.16.3.2 Debugging with software watchdog enabled

If the device shall be debugged with one of the software watchdogs (independent watchdog / window watchdog) enabled, there is an additional init step necessary to make the watchdog counter stop when the CPU is halted by the debugger. This is configured in the DBGMCU_APB1_FZ register. The following sequence can be used to enable debugging with software watchdogs enabled:

```
//
// Configure both watchdog timers to be halted if the CPU is halted by the debugger
//
*((volatile int *) (0xE0042008)) |= (1 << 11) | (1 << 12);
```

9.16.4 STM32F4xxx

These device are Cortex-M4 based.
All devices of this family are supported by J-Link.

9.16.4.1 ETM init

The following sequence can be used to prepare STM32F4xxx devices for 4-bit ETM tracing:

```
int v;
//
// Enable GPIOE clock
//
*((volatile int *) (0x40023830)) = 0x00000010;
//
// Assign trace pins to alternate function in order
// to make them usable as trace pins
// PE2: Trace clock
// PE3: TRACE_D0
// PE4: TRACE_D1
// PE5: TRACE_D2
// PE6: TRACE_D3
//
*((volatile int *) (0x40021000)) = 0x00002AA0;
//
// DBGMCU_CR, enable trace I/O and configure pins for 4-bit trace.
//
v = *((volatile int *) (0xE0042004));
v &= ~(7 << 5); // Preserve all bits except the trace pin configuration
v |= (7 << 5); // Enable trace I/O and configure pins for 4-bit trace
*((volatile int *) (0xE0042004)) = v;
```

9.16.4.2 Debugging with software watchdog enabled

If the device shall be debugged with one of the software watchdogs (independent watchdog / window watchdog) enabled, there is an additional init step necessary to make the watchdog counter stop when the CPU is halted by the debugger. This is configured in the DBGMCU_APB1_FZ register. The following sequence can be used to enable debugging with software watchdogs enabled:

```
//
// Configure both watchdog timers to be halted if the CPU is halted by the debugger
//
*((volatile int *) (0xE0042008)) |= (1 << 11) | (1 << 12);
```

9.17 Texas Instruments

J-Link has been tested with the following Texas Instruments devices:

- AM3352
- AM3354
- AM3356
- AM3357
- AM3358
- AM3359
- OMAP3530
- OMAP3550
- OMAP4430
- OMAP-L138
- TMS470M
- TMS470R1A64
- TMS470R1A128
- TMS470R1A256
- TMS470R1A288
- TMS470R1A384
- TMS470R1B512
- TMS470R1B768
- TMS470R1B1M
- TMS470R1VF288
- TMS470R1VF688
- TMS470R1VF689

9.17.1 AM335x

The AM335x series devices need some special handling which requires that correct device is selected in the J-Link DLL. When used out of a debugger, this is usually done automatically (see *Software reset* on page 240). For J-Link Commander & J-Link GDBServer this needs to be done automatically

9.17.1.1 Selecting the device in the IDE

When using J-Link in an IDE, there is usually a way to directly select the device in the IDE, since it usually also needs this information for peripheral register view etc. The selected device is then usually automatically passed to the J-Link DLL.

The screenshot below is an example for a device selection inside emIDE (<http://www.emide.org>).

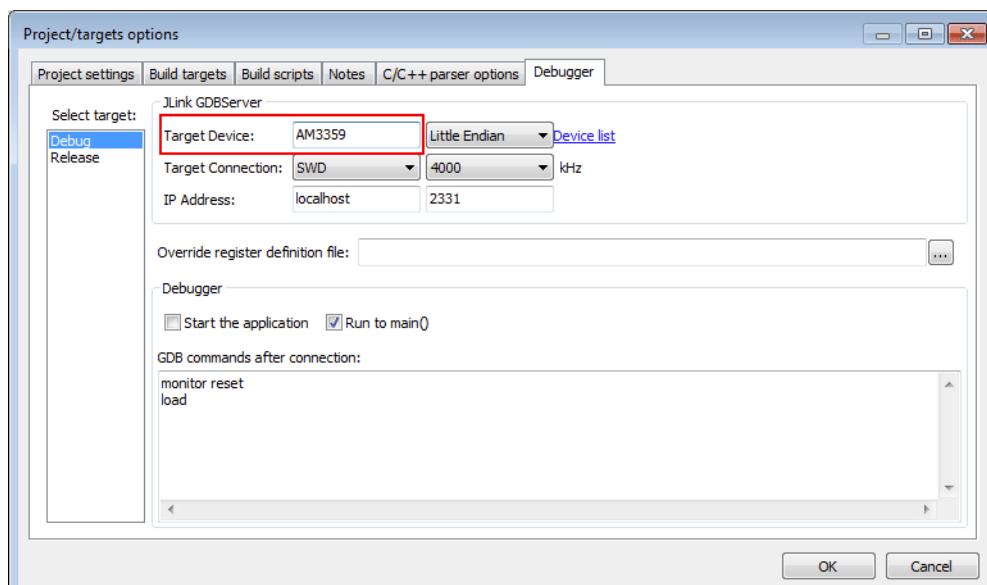

9.17.1.2 Selecting the device when using GDBServer

When using the J-Link GDBServer, the device needs to be known **before** GDB connects to the GDBServer since GDBServer connects to the device as soon as it is started. So selecting the device via monitor command is too late. In order to select the device before GDBServer connects to it, simply start it with the following command line:

```
-device <DeviceName>  
Example: JLinkGDBServer -device AM3359
```

9.17.1.3 Selecting the device when using J-Link Commander

For J-Link Commander, type:

```
device <DeviceName>
```

Then J-Link Commander will perform a reconnect with the device name selected before.

9.17.1.4 Known values for <DeviceName>

For a list of all supported devices, please refer to http://www.segger.com/jlink_supported_devices.html

9.17.1.5 Required J-Link hardware version

The special handling for the AM335x cannot be supported by some older hardware versions of J-Link, so the device cannot be used with these versions.

The following hardware versions come with AM335x support:

- J-Link V8 or later
- J-Link PRO V3 or later
- J-Link ULTRA V4 or later
- Flasher ARM V4 or later

9.17.2 AM35xx / AM37xx

Script is not needed. Refer to AM335x special handling. Same needs to be done for AM35xx / AM37xx.

9.17.3 OMAP4430

Script is not needed. Refer to AM335x special handling. Same needs to be done for AM35xx / AM37xx.

9.17.4 OMAP-L138

Needs a J-Link script file to guarantee proper functionality.

J-Link script file can be found at `$JLINK_INST_DIR$\Samples\JLink\Scripts`

For more information about how to use J-Link script files, please refer to *Executing J-Link script files* on page 174.

9.17.5 TMS470M

Needs a J-Link script file to guarantee proper functionality.

J-Link script file can be found at `$JLINK_INST_DIR$\Samples\JLink\Scripts`

For more information about how to use J-Link script files, please refer to *Executing J-Link script files* on page 174.

9.17.6 OMAP3530

Needs a J-Link script file to guarantee proper functionality.

J-Link script file can be found at `$JLINK_INST_DIR$\Samples\JLink\Scripts`

For more information about how to use J-Link script files, please refer to *Executing J-Link script files* on page 174.

9.17.7 OMAP3550

Needs a J-Link script file to guarantee proper functionality.

J-Link script file can be found at `$JLINK_INST_DIR$\Samples\JLink\Scripts`

For more information about how to use J-Link script files, please refer to *Executing J-Link script files* on page 174.

9.18 Toshiba

J-Link has been tested with the following Toshiba devices:

- TMPM321F10FG
- TMPM322F10FG
- TMPM323F10FG
- TMPM324F10FG
- TMPM330FDFG
- TMPM330FWFG
- TMPM330FYFG
- TMPM332FWUG
- TMPM333FDFG
- TMPM333FWFG
- TMPM333FYFG
- TMPM341FDXBG
- TMPM341FYXBG
- TMPM360F20FG
- TMPM361F10FG
- TMPM362F10FG
- TMPM363F10FG
- TMPM364F10FG
- TMPM366FDFG
- TMPM366FWFG
- TMPM366FYFG
- TMPM370FYDFG
- TMPM370FYFG
- TMPM372FWUG
- TMPM373FWDUG
- TMPM374FWUG
- TMPM380FWDFG
- TMPM380FWFG
- TMPM380FYDFG
- TMPM380FYFG
- TMPM382FSFG
- TMPM382FWFG
- TMPM395FWXBG

Currently, there are no specifics for these devices.

Chapter 10

Target interfaces and adapters

This chapter gives an overview about J-Link / J-Trace specific hardware details, such as the pinouts and available adapters.

10.1 20-pin JTAG/SWD connector

10.1.1 Pinout for JTAG

J-Link and J-Trace have a JTAG connector compatible to ARM's Multi-ICE. The JTAG connector is a 20 way Insulation Displacement Connector (IDC) keyed box header (2.54mm male) that mates with IDC sockets mounted on a ribbon cable.

*On later J-Link products like the J-link ULTRA, these pins are reserved for firmware extension purposes. They can be left open or connected to GND in normal debug environment. They are not essential for JTAG/SWD in general.

VTref	1 ●	● 2	NC
nTRST	3 ●	● 4	GND
TDI	5 ●	● 6	GND
TMS	7 ●	● 8	GND
TCK	9 ●	● 10	GND
RTCK	11 ●	● 12	GND
TDO	13 ●	● 14	GND*
RESET	15 ●	● 16	GND*
DBGREQ	17 ●	● 18	GND*
5V-Supply	19 ●	● 20	GND*

The following table lists the J-Link / J-Trace JTAG pinout.

PIN	SIGNAL	TYPE	Description
1	VTref	Input	This is the target reference voltage. It is used to check if the target has power, to create the logic-level reference for the input comparators and to control the output logic levels to the target. It is normally fed from Vdd of the target board and must not have a series resistor.
2	Not connected	NC	This pin is not connected in J-Link.
3	nTRST	Output	JTAG Reset. Output from J-Link to the Reset signal of the target JTAG port. Typically connected to nTRST of the target CPU. This pin is normally pulled HIGH on the target to avoid unintentional resets when there is no connection.
5	TDI	Output	JTAG data input of target CPU. It is recommended that this pin is pulled to a defined state on the target board. Typically connected to TDI of the target CPU.
7	TMS	Output	JTAG mode set input of target CPU. This pin should be pulled up on the target. Typically connected to TMS of the target CPU.
9	TCK	Output	JTAG clock signal to target CPU. It is recommended that this pin is pulled to a defined state of the target board. Typically connected to TCK of the target CPU.
11	RTCK	Input	Return test clock signal from the target. Some targets must synchronize the JTAG inputs to internal clocks. To assist in meeting this requirement, you can use a returned, and retimed, TCK to dynamically control the TCK rate. J-Link supports adaptive clocking, which waits for TCK changes to be echoed correctly before making further changes. Connect to RTCK if available, otherwise to GND.
13	TDO	Input	JTAG data output from target CPU. Typically connected to TDO of the target CPU.

Table 10.1: J-Link / J-Trace pinout

PIN	SIGNAL	TYPE	Description
15	RESET	I/O	Target CPU reset signal. Typically connected to the RESET pin of the target CPU, which is typically called "nRST", "nRESET" or "RESET".
17	DBGQRQ	NC	This pin is not connected in J-Link. It is reserved for compatibility with other equipment to be used as a debug request signal to the target system. Typically connected to DBGQRQ if available, otherwise left open.
19	5V-Supply	Output	This pin can be used to supply power to the target hardware. Older J-Links may not be able to supply power on this pin. For more information about how to enable/disable the power supply, please refer to <i>Target power supply</i> on page 276.

Table 10.1: J-Link / J-Trace pinout

Pins 4, 6, 8, 10, 12, 14, 16, 18, 20 are GND pins connected to GND in J-Link. They should also be connected to GND in the target system.

10.1.1.1 Target board design

We strongly advise following the recommendations given by the chip manufacturer. These recommendations are normally in line with the recommendations given in the table *Pinout for JTAG* on page 274. In case of doubt you should follow the recommendations given by the semiconductor manufacturer.

You may take any female header following the specifications of DIN 41651. For example:

Harting	part-no. 09185206803
Molex	part-no. 90635-1202
Tyco Electronics	part-no. 2-215882-0

Typical target connection for JTAG

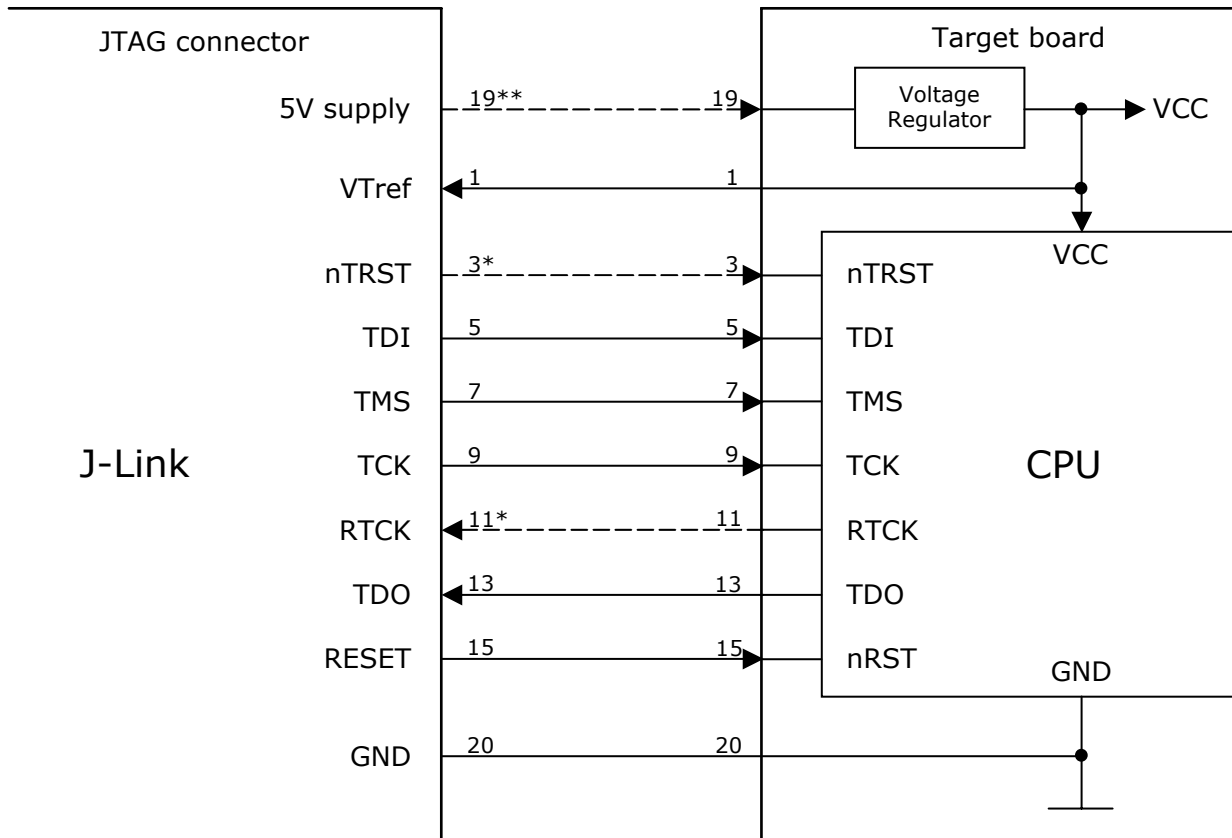

* NTRST and RTCK may not be available on some CPUs.

** Optional to supply the target board from J-Link.

10.1.1.2 Pull-up/pull-down resistors

Unless otherwise specified by developer's manual, pull-ups/pull-downs are recommended to 100 kOhms.

10.1.1.3 Target power supply

Pin 19 of the connector can be used to supply power to the target hardware. Supply voltage is 5V, max. current is 300mA. The output current is monitored and protected against overload and short-circuit. Power can be controlled via the J-Link commander. The following commands are available to control power:

Command	Explanation
<code>power on</code>	Switch target power on
<code>power off</code>	Switch target power off
<code>power on perm</code>	Set target power supply default to "on"
<code>power off perm</code>	Set target power supply default to "off"

Table 10.2: Command List

10.1.2 Pinout for SWD

The J-Link and J-Trace JTAG connector is also compatible to ARM's Serial Wire Debug (SWD).

*On later J-Link products like the J-link ULTRA, these pins are reserved for firmware extension purposes. They can be left open or connected to GND in normal debug environment. They are not essential for JTAG/SWD in general.

The following table lists the J-Link / J-Trace SWD pinout.

VTref	1 ●	● 2	NC
Not used	3 ●	● 4	GND
Not used	5 ●	● 6	GND
SWDIO	7 ●	● 8	GND
SWCLK	9 ●	● 10	GND
Not used	11 ●	● 12	GND
SWO	13 ●	● 14	GND*
RESET	15 ●	● 16	GND*
Not used	17 ●	● 18	GND*
5V-Supply	19 ●	● 20	GND*

PIN	SIGNAL	TYPE	Description
1	VTref	Input	This is the target reference voltage. It is used to check if the target has power, to create the logic-level reference for the input comparators and to control the output logic levels to the target. It is normally fed from Vdd of the target board and must not have a series resistor.
2	Not connected	NC	This pin is not connected in J-Link.
3	Not Used	NC	This pin is not used by J-Link. If the device may also be accessed via JTAG, this pin may be connected to nTRST, otherwise leave open.
5	Not used	NC	This pin is not used by J-Link. If the device may also be accessed via JTAG, this pin may be connected to TDI, otherwise leave open.
7	SWDIO	I/O	Single bi-directional data pin. A pull-up resistor is required. ARM recommends 100 kOhms.
9	SWCLK	Output	Clock signal to target CPU. It is recommended that this pin is pulled to a defined state on the target board. Typically connected to TCK of target CPU.
11	Not used	NC	This pin is not used by J-Link when operating in SWD mode. If the device may also be accessed via JTAG, this pin may be connected to RTCK, otherwise leave open.
13	SWO	Input	Serial Wire Output trace port. (Optional, not required for SWD communication.)
15	RESET	I/O	Target CPU reset signal. Typically connected to the RESET pin of the target CPU, which is typically called "nRST", "nRESET" or "RESET".
17	Not used	NC	This pin is not connected in J-Link.
19	5V-Supply	Output	This pin can be used to supply power to the target hardware. Older J-Links may not be able to supply power on this pin. For more information about how to enable/disable the power supply, please refer to <i>Target power supply</i> on page 278.

Table 10.3: J-Link / J-Trace SWD pinout

Pins 4, 6, 8, 10, 12, 14, 16, 18, 20 are GND pins connected to GND in J-Link. They should also be connected to GND in the target system.

10.1.2.1 Target board design

We strongly advise following the recommendations given by the chip manufacturer. These recommendations are normally in line with the recommendations given in the table *Pinout for SWD* on page 277. In case of doubt you should follow the recommendations given by the semiconductor manufacturer.

Typical target connection for SWD

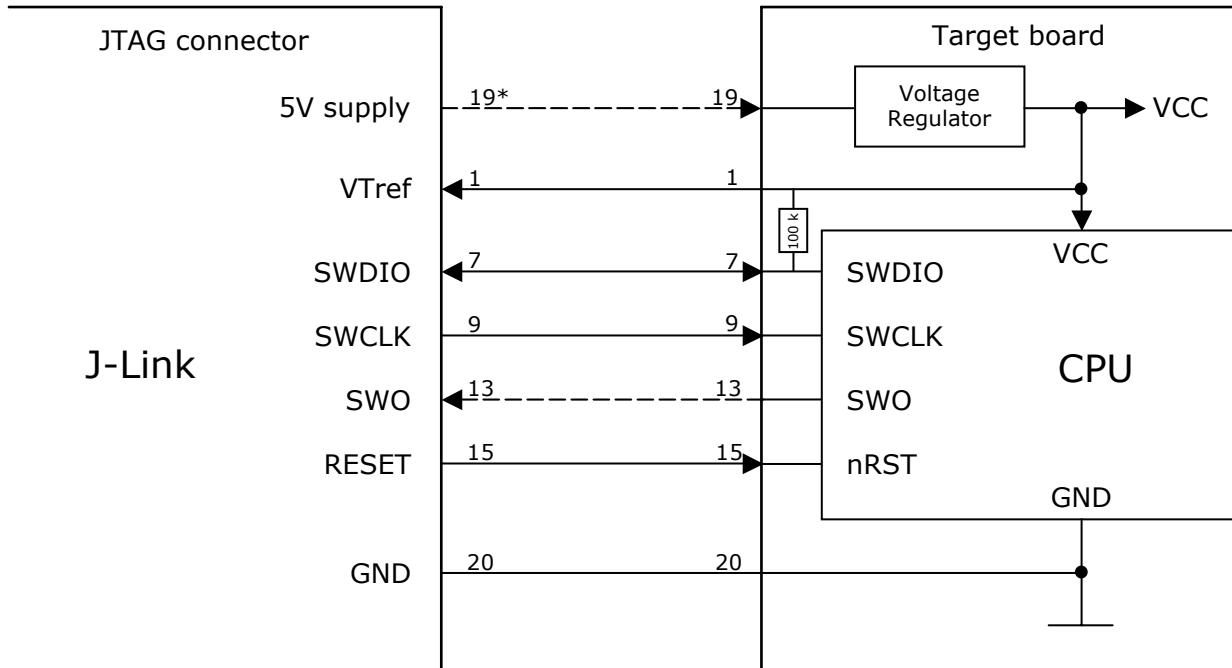

* Optional to supply the target board from J-Link.

10.1.2.2 Pull-up/pull-down resistors

A pull-up resistor is required on SWDIO on the target board. ARM recommends 100 kOhms.

In case of doubt you should follow the recommendations given by the semiconductor manufacturer.

10.1.2.3 Target power supply

Pin 19 of the connector can be used to supply power to the target hardware. Supply voltage is 5V, max. current is 300mA. The output current is monitored and protected against overload and short-circuit.

Power can be controlled via the J-Link commander. The following commands are available to control power:

Command	Explanation
<code>power on</code>	Switch target power on
<code>power off</code>	Switch target power off
<code>power on perm</code>	Set target power supply default to "on"
<code>power off perm</code>	Set target power supply default to "off"

Table 10.4: Command List

10.1.3 Pinout for SWD + Virtual COM Port (VCOM)

The J-Link and J-Trace JTAG connector is also compatible to ARM's Serial Wire Debug (SWD).

*On later J-Link products like the J-link ULTRA, these pins are reserved for firmware extension purposes. They can be left open or connected to GND in normal debug environment. They are not essential for JTAG/SWD in general.

The following table lists the J-Link / J-Trace SWD pinout.

VTref	1 ● ● 2	NC
Not used	3 ● ● 4	GND
J-Link Tx	5 ● ● 6	GND
SWDIO	7 ● ● 8	GND
SWCLK	9 ● ● 10	GND
Not used	11 ● ● 12	GND
SWO	13 ● ● 14	GND*
RESET	15 ● ● 16	GND*
J-Link Rx	17 ● ● 18	GND*
5V-Supply	19 ● ● 20	GND*

PIN	SIGNAL	TYPE	Description
1	VTref	Input	This is the target reference voltage. It is used to check if the target has power, to create the logic-level reference for the input comparators and to control the output logic levels to the target. It is normally fed from Vdd of the target board and must not have a series resistor.
2	Not connected	NC	This pin is not connected in J-Link.
3	Not Used	NC	This pin is not used by J-Link. If the device may also be accessed via JTAG, this pin may be connected to nTRST, otherwise leave open.
5	J-Link Tx	Output	This pin is used as VCOM Tx (out on J-Link side) in case VCOM functionality of J-Link is enabled. For further information about VCOM, please refer to <i>Virtual COM Port (VCOM)</i> on page 185.
7	SWDIO	I/O	Single bi-directional data pin. A pull-up resistor is required. ARM recommends 100 kOhms.
9	SWCLK	Output	Clock signal to target CPU. It is recommended that this pin is pulled to a defined state on the target board. Typically connected to TCK of target CPU.
11	Not used	NC	This pin is not used by J-Link when operating in SWD mode. If the device may also be accessed via JTAG, this pin may be connected to RTCK, otherwise leave open.
13	SWO	Input	Serial Wire Output trace port. (Optional, not required for SWD communication.)
15	RESET	I/O	Target CPU reset signal. Typically connected to the RESET pin of the target CPU, which is typically called "nRST", "nRESET" or "RESET".
17	J-Link Rx	input	This pin is used as VCOM Rx (in on J-Link side) in case VCOM functionality of J-Link is enabled. For further information, please refer to <i>Virtual COM Port (VCOM)</i> on page 185.
19	5V-Supply	Output	This pin can be used to supply power to the target hardware. Older J-Links may not be able to supply power on this pin. For more information about how to enable/disable the power supply, please refer to <i>Target power supply</i> on page 278.

Table 10.5: J-Link / J-Trace SWD pinout

Pins 4, 6, 8, 10, 12, 14, 16, 18, 20 are GND pins connected to GND in J-Link. They should also be connected to GND in the target system.

10.2 38-pin Mictor JTAG and Trace connector

J-Trace provides a JTAG+Trace connector. This connector is a 38-pin mictor plug. It connects to the target via a 1-1 cable.

The connector on the target board should be "TYCO type 5767054-1" or a compatible receptacle. J-Trace supports 4, 8, and 16-bit data port widths with the high density target connector described below.

Target board trace connector

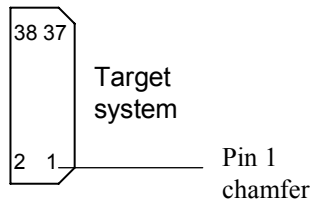

J-Trace can capture the state of signals PIPESTAT[2:0], TRACESYNC and TRACEPKT[n:0] at each rising edge of each TRACECLK or on each alternate rising or falling edge.

10.2.1 Connecting the target board

J-Trace connects to the target board via a 38-pin trace cable. This cable has a receptacle on the one side, and a plug on the other side. Alternatively J-Trace can be connected with a 20-pin JTAG cable.

Warning: Never connect trace cable and JTAG cable at the same time because this may harm your J-Trace and/or your target.

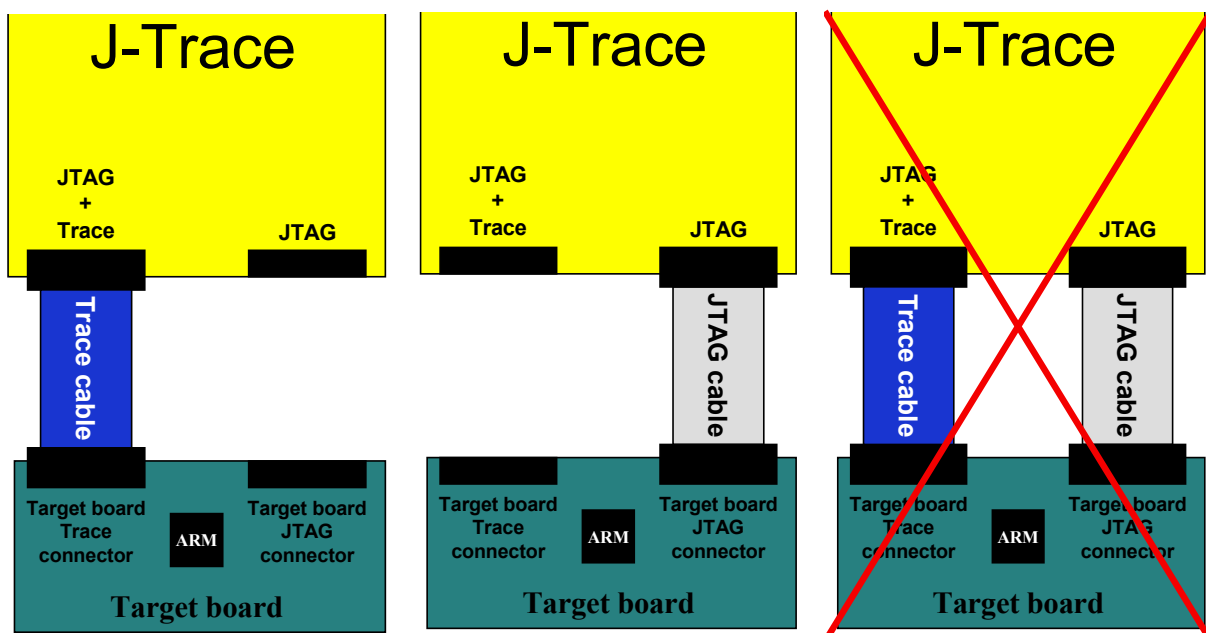

10.2.2 Pinout

The following table lists the JTAG+Trace connector pinout. It is compatible to the "Trace Port Physical Interface" described in [ETM], 8.2.2 "Single target connector pinout".

PIN	SIGNAL	Description
1	NC	No connected.
2	NC	No connected.
3	NC	No connected.
4	NC	No connected.
5	GND	Signal ground.
6	TRACECLK	Clocks trace data on rising edge or both edges.
7	DBGREQ	Debug request.
8	DBGACK	Debug acknowledge from the test chip, high when in debug state.
9	RESET	Open-collector output from the run control to the target system reset.
10	EXTTRIG	Optional external trigger signal to the Embedded trace Macrocell (ETM). Not used. Leave open on target system.
11	TDO	Test data output from target JTAG port.
12	VTRef	Signal level reference. It is normally fed from Vdd of the target board and must not have a series resistor.
13	RTCK	Return test clock from the target JTAG port.
14	VSupply	Supply voltage. It is normally fed from Vdd of the target board and must not have a series resistor.
15	TCK	Test clock to the run control unit from the JTAG port.
16	Trace signal 12	Trace signal. For more information, please refer to <i>Assignment of trace information pins between ETM architecture versions</i> on page 283.
17	TMS	Test mode select from run control to the JTAG port.
18	Trace signal 11	Trace signal. For more information, please refer to <i>Assignment of trace information pins between ETM architecture versions</i> on page 283.
19	TDI	Test data input from run control to the JTAG port.
20	Trace signal 10	Trace signal. For more information, please refer to <i>Assignment of trace information pins between ETM architecture versions</i> on page 283.
21	nTRST	Active-low JTAG reset

Table 10.6: JTAG+Trace connector pinout

PIN	SIGNAL	Description
22	Trace signal 9	Trace signals. For more information, please refer to <i>Assignment of trace information pins between ETM architecture versions</i> on page 283.
23	Trace signal 20	
24	Trace signal 8	
25	Trace signal 19	
26	Trace signal 7	
27	Trace signal 18	
28	Trace signal 6	
29	Trace signal 17	
30	Trace signal 5	
31	Trace signal 16	
32	Trace signal 4	
33	Trace signal 15	
34	Trace signal 3	
35	Trace signal 14	
36	Trace signal 2	
37	Trace signal 13	
38	Trace signal 1	

Table 10.6: JTAG+Trace connector pinout

10.2.3 Assignment of trace information pins between ETM architecture versions

The following table show different names for the trace signals depending on the ETM architecture version.

Trace signal	ETMv1	ETMv2	ETMv3
Trace signal 1	PIPESTAT[0]	PIPESTAT[0]	TRACEDATA[0]
Trace signal 2	PIPESTAT[1]	PIPESTAT[1]	TRACECTL
Trace signal 3	PIPESTAT[2]	PIPESTAT[2]	Logic 1
Trace signal 4	TRACESYNC	PIPESTAT[3]	Logic 0
Trace signal 5	TRACEPKT[0]	TRACEPKT[0]	Logic 0
Trace signal 6	TRACEPKT[1]	TRACEPKT[1]	TRACEDATA[1]
Trace signal 7	TRACEPKT[2]	TRACEPKT[2]	TRACEDATA[2]
Trace signal 8	TRACEPKT[3]	TRACEPKT[3]	TRACEDATA[3]
Trace signal 9	TRACEPKT[4]	TRACEPKT[4]	TRACEDATA[4]
Trace signal 10	TRACEPKT[5]	TRACEPKT[5]	TRACEDATA[5]
Trace signal 11	TRACEPKT[6]	TRACEPKT[6]	TRACEDATA[6]
Trace signal 12	TRACEPKT[7]	TRACEPKT[7]	TRACEDATA[7]
Trace signal 13	TRACEPKT[8]	TRACEPKT[8]	TRACEDATA[8]
Trace signal 14	TRACEPKT[9]	TRACEPKT[9]	TRACEDATA[9]
Trace signal 15	TRACEPKT[10]	TRACEPKT[10]	TRACEDATA[10]
Trace signal 16	TRACEPKT[11]	TRACEPKT[11]	TRACEDATA[11]
Trace signal 17	TRACEPKT[12]	TRACEPKT[12]	TRACEDATA[12]
Trace signal 18	TRACEPKT[13]	TRACEPKT[13]	TRACEDATA[13]
Trace signal 19	TRACEPKT[14]	TRACEPKT[14]	TRACEDATA[14]
Trace signal 20	TRACEPKT[15]	TRACEPKT[15]	TRACEDATA[15]

Table 10.7: Assignment of trace information pins between ETM architecture versions

10.2.4 Trace signals

Data transfer is synchronized by TRACECLK.

10.2.4.1 Signal levels

The maximum capacitance presented by J-Trace at the trace port connector, including the connector and interfacing logic, is less than 6pF. The trace port lines have a matched impedance of 50.

The J-Trace unit will operate with a target board that has a supply voltage range of 3.0V-3.6V.

10.2.4.2 Clock frequency

For capturing trace port signals synchronous to TRACECLK, J-Trace supports a TRACECLK frequency of up to 200MHz. The following table shows the TRACECLK frequencies and the setup and hold timing of the trace signals with respect to TRACECLK.

Parameter	Min.	Max.	Explanation
Tperiod	5ns	1000ns	Clock period
Fmax	1MHz	200MHz	Maximum trace frequency
Tch	2.5ns	-	High pulse width
Tcl	2.5ns	-	Low pulse width

Table 10.8: Clock frequency

Parameter	Min.	Max.	Explanation
Tsh	2.5ns	-	Data setup high
Thh	1.5ns	-	Data hold high
Tsl	2.5ns	-	Data setup low
Thl	1.5ns	-	Data hold low

Table 10.8: Clock frequency

The diagram below shows the TRACECLK frequencies and the setup and hold timing of the trace signals with respect to TRACECLK.

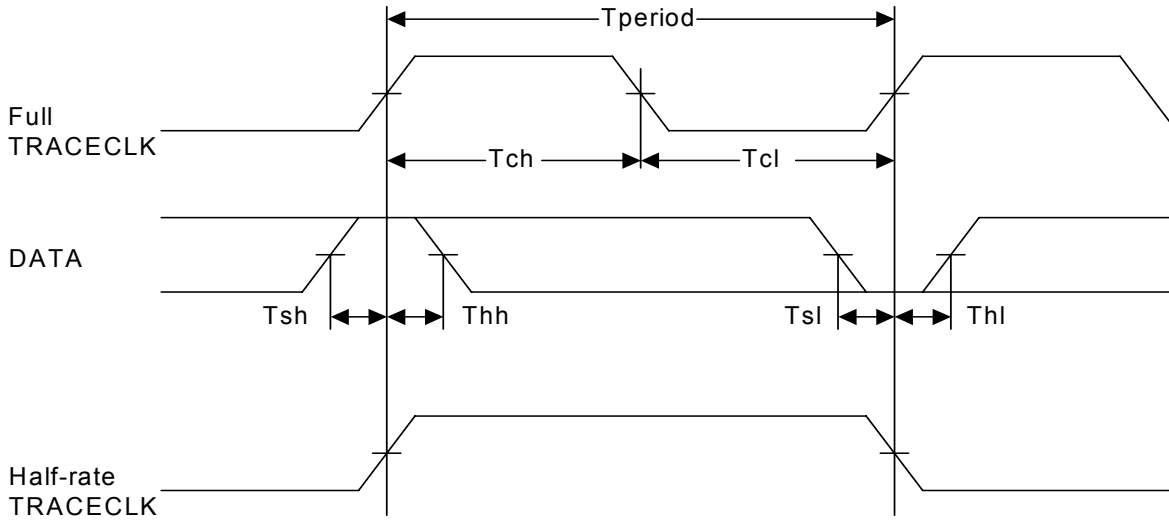

Note: J-Trace supports half-rate clocking mode. Data is output on each edge of the TRACECLK signal and TRACECLK (max) ≤ 100MHz. For half-rate clocking, the setup and hold times at the JTAG+Trace connector must be observed.

10.3 19-pin JTAG/SWD and Trace connector

J-Trace provides a JTAG/SWD+Trace connector. This connector is a 19-pin connector. It connects to the target via an 1-1 cable.

VTref	1 ● ● 2	SWDIO/TMS
GND	3 ● ● 4	SWCLK/TCK
GND	5 ● ● 6	SWO/TDO
---	7 ● 8	TDI
NC	9 ● ● 10	nRESET
5V-Supply	11 ● ● 12	TRACECLK
5V-Supply	13 ● ● 14	TRACEDATA[0]
GND	15 ● ● 16	TRACEDATA[1]
GND	17 ● ● 18	TRACEDATA[2]
GND	19 ● ● 20	TRACEDATA[3]

The following table lists the J-Link / J-Trace SWD pinout.

PIN	SIGNAL	TYPE	Description
1	VTref	Input	This is the target reference voltage. It is used to check if the target has power, to create the logic-level reference for the input comparators and to control the output logic levels to the target. It is normally fed from Vdd of the target board and must not have a series resistor.
2	SWDIO/TMS	I/O / output	SWDIO: (Single) bi-directional data pin. JTAG mode set input of target CPU. This pin should be pulled up on the target. Typically connected to TMS of the target CPU.
4	SWCLK/TCK	Output	SWCLK: Clock signal to target CPU. It is recommended that this pin is pulled to a defined state of the target board. Typically connected to TCK of target CPU. JTAG clock signal to target CPU.
6	SWO/TDO	Input	JTAG data output from target CPU. Typically connected to TDO of the target CPU. When using SWD, this pin is used as Serial Wire Output trace port. (Optional, not required for SWD communication)
---	---	---	This pin (normally pin 7) is not existent on the 19-pin JTAG/SWD and Trace connector.
8	TDI	Output	JTAG data input of target CPU.- It is recommended that this pin is pulled to a defined state on the target board. Typically connected to TDI of the target CPU. For CPUs which do not provide TDI (SWD-only devices), this pin is not used. J-Link will ignore the signal on this pin when using SWD.
9	NC	NC	Not connected inside J-Link. Leave open on target hardware.
10	nRESET	I/O	Target CPU reset signal. Typically connected to the RESET pin of the target CPU, which is typically called "nRST", "nRESET" or "RESET".
11	5V-Supply	Output	This pin can be used to supply power to the target hardware. For more information about how to enable/disable the power supply, please refer to <i>Target power supply</i> on page 286.
12	TRACECLK	Input	Input trace clock. Trace clock = 1/2 CPU clock.
13	5V-Supply	Output	This pin can be used to supply power to the target hardware. For more information about how to enable/disable the power supply, please refer to <i>Target power supply</i> on page 286.
14	TRACE-DATA[0]	Input	Input Trace data pin 0.

Table 10.9: 19-pin JTAG/SWD and Trace pinout

PIN	SIGNAL	TYPE	Description
16	TRACE-DATA[1]	Input	Input Trace data pin 0.
18	TRACE-DATA[2]	Input	Input Trace data pin 0.
20	TRACE-DATA[3]	Input	Input Trace data pin 0.

Table 10.9: 19-pin JTAG/SWD and Trace pinout

Pins 3, 5, 15, 17, 19 are GND pins connected to GND in J-Trace CM3. They should also be connected to GND in the target system.

10.3.1 Target power supply

Pins 11 and 13 of the connector can be used to supply power to the target hardware. Supply voltage is 5V, max. current is 300mA. The output current is monitored and protected against overload and short-circuit.

Power can be controlled via the J-Link commander. The following commands are available to control power:

Command	Explanation
<code>power on</code>	Switch target power on
<code>power off</code>	Switch target power off
<code>power on perm</code>	Set target power supply default to "on"
<code>power off perm</code>	Set target power supply default to "off"

Table 10.10: Command List

10.4 9-pin JTAG/SWD connector

Some target boards only provide a 9-pin JTAG/SWD connector for Cortex-M. For these devices SEGGER provides a 20-pin -> 9-pin Cortex-M adapter.

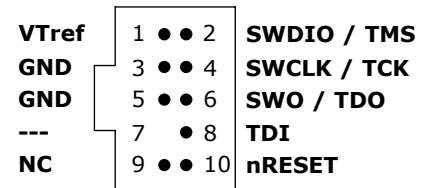

The following table lists the output of the 9-pin Cortex-M connector.

PIN	SIGNAL	TYPE	Description
1	VTref	Input	This is the target reference voltage. It is used to check if the target has power, to create the logic-level reference for the input comparators and to control the output logic levels to the target. It is normally fed from Vdd of the target board and must not have a series resistor.
2	SWDIO/ TMS	I/O / output	SWDIO: (Single) bi-directional data pin. JTAG mode set input of target CPU. This pin should be pulled up on the target. Typically connected to TMS of the target CPU.
4	SWCLK/TCK	Output	SWCLK: Clock signal to target CPU. It is recommended that this pin is pulled to a defined state of the target board. Typically connected to TCK of target CPU. JTAG clock signal to target CPU.
6	SWO/TDO	Input	When using SWD, this pin is used as Serial Wire Output trace port (optional, not required for SWD communication). JTAG data output from target CPU. Typically connected to TDO of the target CPU.
---	---	---	This pin (normally pin 7) is not existent on the 19-pin JTAG/SWD and Trace connector.
8	TDI	Output	JTAG data input of target CPU.- It is recommended that this pin is pulled to a defined state on the target board. Typically connected to TDI of the target CPU. For CPUs which do not provide TDI (SWD-only devices), this pin is not used. J-Link will ignore the signal on this pin when using SWD.
9	NC	NC	Not connected inside J-Link. Leave open on target hardware.

Table 10.11: 9-pin JTAG/SWD pinout

Pins 3 and 5 are GND pins connected to GND on the Cortex-M adapter. They should also be connected to GND in the target system.

10.5 Adapters

There are various adapters available for J-Link as for example the JTAG isolator, the J-Link RX adapter or the J-Link Cortex-M adapter.

For more information about the different adapters, please refer to <http://www.segger.com/jlink-adapters.html>.

Chapter 11

Background information

This chapter provides background information about JTAG and ARM. The ARM7 and ARM9 architecture is based on *Reduced Instruction Set Computer* (RISC) principles. The instruction set and the related decode mechanism are greatly simplified compared with microprogrammed *Complex Instruction Set Computer* (CISC).

11.1 JTAG

JTAG is the acronym for Joint Test Action Group. In the scope of this document, "the JTAG standard" means compliance with IEEE Standard 1149.1-2001.

11.1.1 Test access port (TAP)

JTAG defines a TAP (Test access port). The TAP is a general-purpose port that can provide access to many test support functions built into a component. It is composed as a minimum of the three input connections (TDI, TCK, TMS) and one output connection (TDO). An optional fourth input connection (nTRST) provides for asynchronous initialization of the test logic.

PIN	Type	Explanation
TCK	Input	The test clock input (TCK) provides the clock for the test logic.
TDI	Input	Serial test instructions and data are received by the test logic at test data input (TDI).
TMS	Input	The signal received at test mode select (TMS) is decoded by the TAP controller to control test operations.
TDO	Output	Test data output (TDO) is the serial output for test instructions and data from the test logic.
nTRST	Input (optional)	The optional test reset (nTRST) input provides for asynchronous initialization of the TAP controller.

Table 11.1: Test access port

11.1.2 Data registers

JTAG requires at least two data registers to be present: the bypass and the boundary-scan register. Other registers are allowed but are not obligatory.

Bypass data register

A single-bit register that passes information from TDI to TDO.

Boundary-scan data register

A test data register which allows the testing of board interconnections, access to input and output of components when testing their system logic and so on.

11.1.3 Instruction register

The instruction register holds the current instruction and its content is used by the TAP controller to decide which test to perform or which data register to access. It consist of at least two shift-register cells.

11.1.4 The TAP controller

The TAP controller is a synchronous finite state machine that responds to changes at the TMS and TCK signals of the TAP and controls the sequence of operations of the circuitry.

TAP controller state diagram

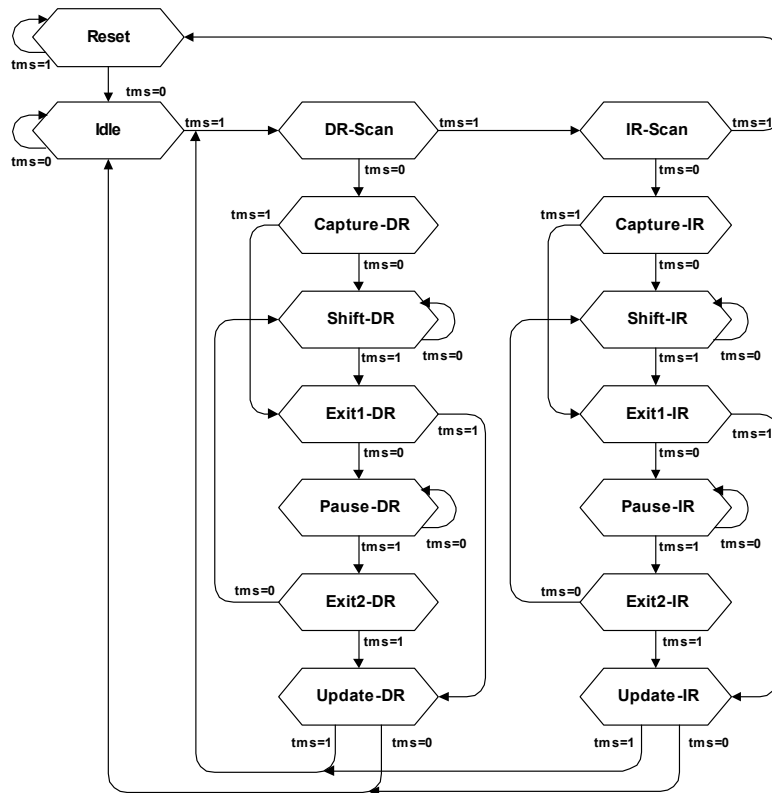

11.1.4.1 State descriptions

Reset

The test logic is disabled so that normal operation of the chip logic can continue unhindered. No matter in which state the TAP controller currently is, it can change into Reset state if TMS is high for at least 5 clock cycles. As long as TMS is high, the TAP controller remains in Reset state.

Idle

Idle is a TAP controller state between scan (DR or IR) operations. Once entered, this state remains active as long as TMS is low.

DR-Scan

Temporary controller state. If TMS remains low, a scan sequence for the selected data registers is initiated.

IR-Scan

Temporary controller state. If TMS remains low, a scan sequence for the instruction register is initiated.

Capture-DR

Data may be loaded in parallel to the selected test data registers.

Shift-DR

The test data register connected between TDI and TDO shifts data one stage towards the serial output with each clock.

Exit1-DR

Temporary controller state.

Pause-DR

The shifting of the test data register between TDI and TDO is temporarily halted.

Exit2-DR

Temporary controller state. Allows to either go back into Shift-DR state or go on to Update-DR.

Update-DR

Data contained in the currently selected data register is loaded into a latched parallel output (for registers that have such a latch). The parallel latch prevents changes at the parallel output of these registers from occurring during the shifting process.

Capture-IR

Instructions may be loaded in parallel into the instruction register.

Shift-IR

The instruction register shifts the values in the instruction register towards TDO with each clock.

Exit1-IR

Temporary controller state.

Pause-IR

Wait state that temporarily halts the instruction shifting.

Exit2-IR

Temporary controller state. Allows to either go back into Shift-IR state or go on to Update-IR.

Update-IR

The values contained in the instruction register are loaded into a latched parallel output from the shift-register path. Once latched, this new instruction becomes the current one. The parallel latch prevents changes at the parallel output of the instruction register from occurring during the shifting process.

11.2 Embedded Trace Macrocell (ETM)

Embedded Trace Macrocell (ETM) provides comprehensive debug and trace facilities for ARM processors. ETM allows to capture information on the processor's state without affecting the processor's performance. The trace information is exported immediately after it has been captured, through a special trace port.

Microcontrollers that include an ETM allow detailed program execution to be recorded and saved in real time. This information can be used to analyze program flow and execution time, perform profiling and locate software bugs that are otherwise very hard to locate. A typical situation in which code trace is extremely valuable, is to find out how and why a "program crash" occurred in case of a runaway program count.

A debugger provides the user interface to J-Trace and the stored trace data. The debugger enables all the ETM facilities and displays the trace information that has been captured. J-Trace is seamlessly integrated into the IAR Embedded Workbench® IDE. The advanced trace debugging features can be used with the IAR C-SPY debugger.

11.2.1 Trigger condition

The ETM can be configured in software to store trace information only after a specific sequence of conditions. When the trigger condition occurs the trace capture stops after a programmable period.

11.2.2 Code tracing and data tracing

Code trace

Code tracing means that the processor outputs trace data which contain information about the instructions that have been executed at last.

Data trace

Data tracing means that the processor outputs trace data about memory accesses (read / write access to which address and which data has been read / stored). In general, J-Trace supports data tracing, but it depends on the debugger if this option is available or not. Note that when using data trace, the amount of trace data to be captured rises enormously.

11.2.3 J-Trace integration example - IAR Embedded Workbench for ARM

In the following a sample integration of J-Trace and the trace functionality on the debugger side is shown. The sample is based on IAR's Embedded Workbench for ARM integration of J-Trace.

11.2.3.1 Code coverage - Disassembly tracing

The screenshot displays the IAR Embedded Workbench IDE interface for disassembly tracing. The main window is divided into three primary sections:

- Source Code (Left):** Shows C code for a microcontroller, including initialization of clocks, NVIC, and GPIOs. Line 210 is highlighted, corresponding to the current instruction in the disassembly window.
- Disassembly (Right):** Shows the assembly code for the selected line. The instruction `LDR R0, [PC, #0x108]` is highlighted in red, indicating the current instruction being traced.
- Trace Table (Bottom):** A table listing the execution of instructions. The table has columns for Index, Frame, Address, Opcode, Trace, and Comment. The instruction at index 003096 is highlighted in yellow, matching the instruction in the disassembly window.

Index	Frame	Address	Opcode	Trace	Comment
003064	003382	0x0800889E	E004	B	??NVIC_SetvectorTable_2
003065	003383	0x080088AA	4807	LDR R0, [PC, #0x1C]	assert_param(IS_NVIC_OFFSET(Offset));
003066	003384	0x080088AC	4285	CMP R5, R0	??NVIC_SetvectorTable_21
003067	003385	0x080088AE	D304	BCC	??NVIC_SetvectorTable_4
003068	003386	0x0800888A	4804	LDR R0, [PC, #0x10]	SCB->VTOR = NVIC_VectTab (Offset & (U32)0x1FFFFFF0);
003069	003387	0x0800888C	4028	ANDS R0, R0, R5	??NVIC_SetvectorTable_41
003070	003388	0x0800888E	4320	ORRS R0, R0, R4	??NVIC_SetvectorTable_42
003071	003389	0x080088C0	4904	LDR R1, [PC, #0x10]	??NVIC_SetvectorTable_43
003072	003390	0x080088C2	6809	LDR R1, [R1]	??NVIC_SetvectorTable_44
003073	003391	0x080088C4	6088	STR R0, [R1, #0x8]	??NVIC_SetvectorTable_45
003074	003392	0x080088C6	B031	POP (R0,R4,R5,PC)	??NVIC_SetvectorTable_46
003075	003393	0x080088C2	F44F	MOV R0, #0x300	NVIC_PriorityGroupConfig(NVIC_PriorityGroup_4);
003076	003394	0x080088FC	F001	BL	NVIC_PriorityGroupConfig
003077	003395	0x0800884C	B510	PUSH (R4,LR)	void NVIC_PriorityGroupConfig(u32 NVIC_PriorityGroup)
003078	003396	0x0800884E	0004	MOVFS R4, R0	NVIC_PriorityGroupConfig:
003079	003397	0x08008850	F5B4	CMP R4, #0x700	assert_param(IS_NVIC_PRIORITY_GROUP(NVIC_PriorityGroup));
003080	003398	0x08008854	F5B4	CMP R4, #0x600	Not executed
003081	003399	0x08008856	F5B4	CMP R4, #0x500	Not executed
003082	003400	0x0800885A	F5B4	CMP R4, #0x400	Not executed
003083	003401	0x0800885C	F5B4	CMP R4, #0x300	Not executed
003084	003402	0x08008860	F5B4	CMP R4, #0x200	Not executed
003085	003403	0x08008862	F5B4	CMP R4, #0x100	Not executed
003086	003404	0x08008866	F5B4	CMP R4, #0x000	Not executed
003087	003405	0x08008868	F5B4	CMP R4, #0x300	Not executed
003088	003406	0x0800886C	F5B4	CMP R4, #0x300	Not executed
003089	003407	0x0800886E	E004	B	??NVIC_PriorityGroupConfig_0:
003090	003408	0x0800887A	F8F0	LDR.W R0, [PC, #0x58]	??NVIC_PriorityGroupConfig_2
003091	003409	0x0800887E	6800	LDR R0, [R0]	SCB->AIRCR = AIRCR->SETSYSMASK NVIC_PriorityGroup;
003092	003410	0x08008880	4901	LDR R1, [PC, #0x4]	??NVIC_PriorityGroupConfig_2:
003093	003411	0x08008882	4321	ORRS R1, R1, R4	??NVIC_PriorityGroupConfig_2:
003094	003412	0x08008884	60C1	STR R1, [R0, #0xC]	??NVIC_PriorityGroupConfig_2:
003095	003413	0x08008886	B010	POP (R4,PC)	??NVIC_PriorityGroupConfig_2:
003096	003414	0x080088CA	4876	LDR R0, [PC, #0x108]	SystemTick_SetReload(900000);

11.2.3.2 Code coverage - Source code tracing

The screenshot displays the IAR Embedded Workbench IDE interface for source code tracing. It is divided into three main sections:

- Source Code (Top):** Shows C code for a microcontroller application. Key functions include `CLK_Init()`, `NVIC_Init()`, `SystemTick_Init()`, and `GPIO_Init()`. Line 209 is highlighted with a red box, indicating the current execution point.
- Disassembly (Middle):** Shows the assembly instructions corresponding to the source code. Instructions like `RCC_GetFlagStatus(u8)` and `CLK_Init() + 66` are visible, with some highlighted in red and yellow.
- Execution Trace (Bottom):** A table showing the sequence of instructions executed. The table has the following columns: Index, Frame, Address, Opcode, Trace, and Comment. The trace shows a series of `RCC_GetFlagStatus(u8)` and `CLK_Init() + 66` instructions, with the final instruction at index 003096 being `main() + 34`.

Index	Frame	Address	Opcode	Trace	Comment
002368	002686	0x0800B5A4	B510	RCC_GetFlagStatus(u8)	
002403	002721	0x0800BEE6	2E00	CLK_Init() + 66	
002407	002725	0x0800B5A4	B510	RCC_GetFlagStatus(u8)	
002442	002760	0x0800BEE6	2E00	CLK_Init() + 66	
002446	002764	0x0800B5A4	B510	RCC_GetFlagStatus(u8)	
002481	002799	0x0800BEE6	2E00	CLK_Init() + 66	
002485	002803	0x0800B5A4	B510	RCC_GetFlagStatus(u8)	
002520	002838	0x0800BEE6	2E00	CLK_Init() + 66	
002524	002842	0x0800B5A4	B510	RCC_GetFlagStatus(u8)	
002559	002877	0x0800BEE6	2E00	CLK_Init() + 66	
002563	002881	0x0800B5A4	B510	RCC_GetFlagStatus(u8)	
002598	002916	0x0800BEE6	2E00	CLK_Init() + 66	
002602	002920	0x0800B5A4	B510	RCC_GetFlagStatus(u8)	
002637	002955	0x0800BEE6	2E00	CLK_Init() + 66	
002641	002959	0x0800B5A4	B510	RCC_GetFlagStatus(u8)	
002676	002994	0x0800BEE6	2E00	CLK_Init() + 66	
002680	002998	0x0800B5A4	B510	RCC_GetFlagStatus(u8)	
002715	003033	0x0800BEE6	2E00	CLK_Init() + 66	
002719	003037	0x0800B5A4	B510	RCC_GetFlagStatus(u8)	
002754	003072	0x0800BEE6	2E00	CLK_Init() + 66	
002758	003076	0x0800B5A4	B510	RCC_GetFlagStatus(u8)	
002793	003111	0x0800BEE6	2E00	CLK_Init() + 66	
002797	003115	0x0800B5A4	B510	RCC_GetFlagStatus(u8)	
002832	003150	0x0800BEE6	2E00	CLK_Init() + 66	
002836	003154	0x0800B5A4	B510	RCC_GetFlagStatus(u8)	
002871	003189	0x0800BEE6	2E00	CLK_Init() + 66	
002875	003193	0x0800B3C8	B510	RCC_USBCLKConfig(u32)	
002883	003201	0x0800BEC8	F44F	CLK_Init() + 76	
002885	003203	0x0800B3EC	B510	RCC_ADCLKConfig(u32)	
002906	003224	0x0800B0D0	2000	CLK_Init() + 84	
002908	003226	0x0800B37C	B510	RCC_PCLK2Config(u32)	
002923	003241	0x0800BED6	F44F	CLK_Init() + 90	
002925	003243	0x0800B334	B510	RCC_PCLK1Config(u32)	
002942	003260	0x0800B0DE	2000	CLK_Init() + 98	
002944	003262	0x0800B2E4	B510	RCC_HCLKConfig(u32)	
002959	003277	0x0800BEE4	2002	CLK_Init() + 104	
002961	003279	0x0800D70C	B510	FLASH_SetLatency(u32)	
002985	003303	0x0800BEE4	2000	CLK_Init() + 110	
002987	003305	0x0800D746	B510	FLASH_HalTcycleAccessCmd(u32)	
003009	003327	0x0800BFF0	2010	CLK_Init() + 116	
003011	003329	0x0800D77C	B510	FLASH_PrefetchBufferCmd(u32)	
003031	003349	0x0800B0F6	2002	CLK_Init() + 122	
003033	003351	0x0800B2AC	B510	RCC_SYSClkConfig(u32)	
003053	003371	0x0800BFFC	B001	CLK_Init() + 128	
003054	003372	0x0800BFF8	2100	main() + 16	
003057	003375	0x0800B09C	B578	NVIC_SetVectorTable(u32, u32)	
003075	003393	0x0800BFC2	F44F	main() + 26	
003077	003395	0x0800B04C	B510	NVIC_PriorityGroupConfig(u32)	
003096	003414	0x0800BFCA	4876	main() + 34	

The screenshot displays the IAR Embedded Workbench IDE interface. The main window shows C code for the `NVIC_PriorityGroupConfig` function. The code includes comments describing the function's purpose, its input parameters (priority grouping bits and subpriority), and its output (none). It also shows the initialization of the `NVIC_InitTypeDef` structure and the call to `NVIC_Init`.

The assembly window on the right shows the corresponding assembly code for the `NVIC_PriorityGroupConfig` function. It starts with a `PUSH` instruction to save registers, followed by several `MOV` instructions to load constants and register values into the `R4` register. The code then branches to `??NVIC_PriorityGroupConfig_0` through `??NVIC_PriorityGroupConfig_2`, which are likely subroutines for different priority group configurations.

The bottom window shows the execution trace, listing instructions with their addresses, opcodes, and comments. The trace shows the execution of the `NVIC_PriorityGroupConfig` function, starting at address `0x080084C` and ending at `0x0800876`.

11.3 Embedded Trace Buffer (ETB)

The ETB is a small, circular on-chip memory area where trace information is stored during capture. It contains the data which is normally exported immediately after it has been captured from the ETM. The buffer can be read out through the JTAG port of the device once capture has been completed. No additional special trace port is required, so that the ETB can be read via J-Link. The trace functionality via J-Link is limited by the size of the ETB. While capturing runs, the trace information in the buffer will be overwritten every time the buffer size has been reached.

```

J-Link ARM
SEGGER J-Link Commander V3.72c ('?' for help)
Compiled Jul  4 2007 20:17:14
DLL version V3.72c, compiled Jul  4 2007 20:17:09
Firmware: J-Link compiled Jun 14 2007 14:36:33 ARM Rev.5
Hardware: U5.30
S/N : 1
Feature(s) : RDI, FlashBP, FlashDL, JFlash, GDB
UTarget = 3.119U
JTAG speed: 30 kHz
Info: CP15.0.0: 0x41069264: ARM, Architecture 5TEJ
Info: CP15.0.1: 0x1D192192: ICache: 32kB <4*256*32>, DCache: 32kB <4*256*32>
Found 2 JTAG devices, Total IRLen = 8:
  Id of device #0: 0x1B900F0F
  Id of device #1: 0x17900F0F
Found ARM with core Id 0x17900F0F (ARM9)
  ETM V1.3: 8 pairs addr.comp, 8 data comp, 16 MM decs, 4 counters, sequencer
  ETB V1.0: 2048x24 bit RAM
J-Link>etb
ETB is present.
ID register      (ETB[0x001]) : 1B900F0F
RAM depth       (ETB[0x011]) : 00000800
RAM width       (ETB[0x021]) : 00000018
Status          (ETB[0x031]) : 00000008
RAM data        (ETB[0x041]) : 00CBB1B7
RAM read pointer (ETB[0x051]) : 00000000
RAM write pointer (ETB[0x061]) : 00000000
Trigger counter (ETB[0x071]) : 00000000
Control         (ETB[0x081]) : 00000000
J-Link>

```

The result of the limited buffer size is that not more data can be traced than the buffer can hold. Through this limitation is an ETB not in every case an fully-fledged alternative to the direct access to an ETM via J-Trace.

11.4 Flash programming

J-Link / J-Trace comes with a DLL, which allows - amongst other functionalities - reading and writing RAM, CPU registers, starting and stopping the CPU, and setting breakpoints. The standard DLL does not have API functions for flash programming. However, the functionality offered can be used to program the flash. In that case, a flashloader is required.

11.4.1 How does flash programming via J-Link / J-Trace work?

This requires extra code. This extra code typically downloads a program into the RAM of the target system, which is able to erase and program the flash. This program is called RAM code and "knows" how to program the flash; it contains an implementation of the flash programming algorithm for the particular flash. Different flash chips have different programming algorithms; the programming algorithm also depends on other things such as endianness of the target system and organization of the flash memory (for example 1 * 8 bits, 1 * 16 bits, 2 * 16 bits or 32 bits). The RAM code requires data to be programmed into the flash memory. There are 2 ways of supplying this data: Data download to RAM or data download via DCC.

11.4.2 Data download to RAM

The data (or part of it) is downloaded to an other part of the RAM of the target system. The Instruction pointer (R15) of the CPU is then set to the start address of the Ram code, the CPU is started, executing the RAM code. The RAM code, which contains the programming algorithm for the flash chip, copies the data into the flash chip. The CPU is stopped after this. This process may have to be repeated until the entire data is programmed into the flash.

11.4.3 Data download via DCC

In this case, the RAM code is started as described above before downloading any data. The RAM code then communicates with the host computer (via DCC, JTAG and J-Link / J-Trace), transferring data to the target. The RAM code then programs the data into flash and waits for new data from the host. The WriteMemory functions of J-Link / J-Trace are used to transfer the RAM code only, but not to transfer the data. The CPU is started and stopped only once. Using DCC for communication is typically faster than using WriteMemory for RAM download because the overhead is lower.

11.4.4 Available options for flash programming

There are different solutions available to program internal or external flashes connected to ARM cores using J-Link / J-Trace. The different solutions have different fields of application, but of course also some overlap.

11.4.4.1 J-Flash - Complete flash programming solution

J-Flash is a stand-alone Windows application, which can read / write data files and program the flash in almost any ARM system. J-Flash requires an extra license from SEGGER.

11.4.4.2 RDI flash loader: Allows flash download from any RDI-compliant tool chain

RDI, (Remote debug interface) is a standard for "debug transfer agents" such as J-Link. It allows using J-Link from any RDI compliant debugger. RDI by itself does not include download to flash. To debug in flash, you need to somehow program your application program (debuggee) into the flash. You can use J-Flash for this purpose, use the flash loader supplied by the debugger company (if they supply a matching flash loader) or use the flash loader integrated in the J-Link RDI software. The RDI software as well as the RDI flash loader require licenses from SEGGER.

11.4.4.3 Flash loader of compiler / debugger vendor such as IAR

A lot of debuggers (some of them integrated into an IDE) come with their own flash loaders. The flash loaders can of course be used if they match your flash configuration, which is something that needs to be checked with the vendor of the debugger.

11.4.4.4 Write your own flash loader

Implement your own flash loader using the functionality of the JLinkARM.dll as described above. This can be a time consuming process and requires in-depth knowledge of the flash programming algorithm used as well as of the target system.

11.5 J-Link / J-Trace firmware

The heart of J-Link / J-Trace is a microcontroller. The firmware is the software executed by the microcontroller inside of the J-Link / J-Trace. The J-Link / J-Trace firmware sometimes needs to be updated. This firmware update is performed automatically as necessary by the JLinkARM.dll.

11.5.1 Firmware update

Every time you connect to J-Link / J-Trace, JLinkARM.dll checks if its embedded firmware is newer than the one used the J-Link / J-Trace. The DLL will then update the firmware automatically. This process takes less than 3 seconds and does not require a reboot.

It is recommended that you always use the latest version of JLinkARM.dll.

```

C:\> JLink.exe
SEGGER J-Link Commander V2.68.01. '?' for help.
Compiled 14:02:49 on Oct 25 2005.
Updating firmware: J-Link compiled Oct 20 2005 14:41:31 ARM Rev.5
Replacing firmware: J-Link compiled NOV 17 2005 16:12:19 ARM Rev.5
... Firmware update successful. CRC=5EF3
Waiting for new firmware to boot
DLL version V2.70a, compiled Oct 25 2005 14:02:40
Firmware: J-Link compiled Oct 20 2005 14:41:31 ARM Rev.5
Hardware: V5.00
S/N :
UTarget = 0.0000
Speed set to 30 kHz
J-Link>

```

In the screenshot:

- The red box identifies the new firmware.
- The green box identifies the old firmware which has been replaced.

11.5.2 Invalidating the firmware

Downdating J-Link / J-Trace is not performed automatically through an old JLinkARM.dll. J-Link / J-Trace will continue using its current, newer firmware when using older versions of the JLinkARM.dll.

Note: Downdating J-Link / J-Trace is not recommended, you do it at your own risk!

Note: Note also the firmware embedded in older versions of JLinkARM.dll might not execute properly with newer hardware versions.

To downgrade J-Link / J-Trace, you need to invalidate the current J-Link / J-Trace firmware, using the command `exec InvalidateFW`.

```

C:\> JLink.exe
SEGGER J-Link Commander V2.74.01. '?' for help.
Compiled 10:17:23 on Nov 25 2005.
DLL version V2.74b, compiled Nov 25 2005 10:17:13
Firmware: J-Link compiled Nov 17 2005 16:12:19 ARM Rev.5
Hardware: V5.00
S/N :
UTarget = 0.0000
Speed set to 30 kHz
J-Link>exec invalidatefw
Info: Updating firmware: J-Link compiled NOV 17 2005 16:12:19 ARM Rev.5
Info: Replacing firmware: J-Link compiled Nov 17 2005 16:12:19 ARM Rev.5
Info: ... Firmware update successful. CRC=CD83
Info: Waiting for new firmware to boot
J-Link>

```

In the screenshot, the red box contains information about the formerly used J-Link / J-Trace firmware version.

Use an application (for example JLink.exe) which uses the desired version of JLinkARM.dll. This automatically replaces the invalidated firmware with its embedded firmware.

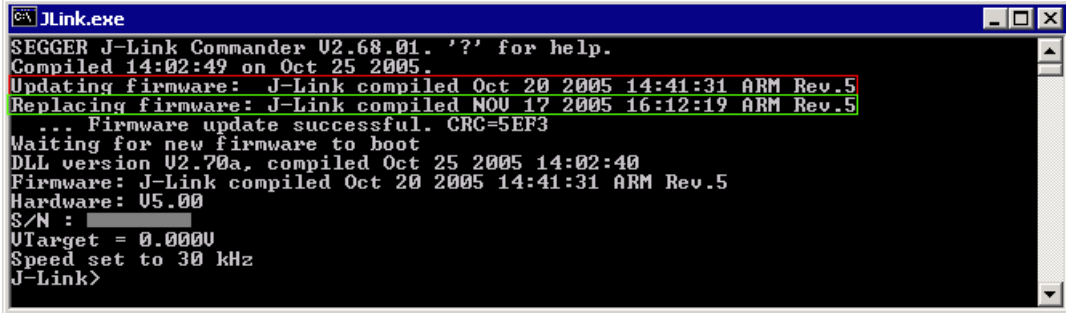

```
JLink.exe
SEGGER J-Link Commander V2.68.01. '?' for help.
Compiled 14:02:49 on Oct 25 2005.
Updating firmware: J-Link compiled Oct 20 2005 14:41:31 ARM Rev.5
Replacing firmware: J-Link compiled NOV 17 2005 16:12:19 ARM Rev.5
... Firmware update successful. CRC=5EF3
Waiting for new firmware to boot
DLL version V2.70a, compiled Oct 25 2005 14:02:40
Firmware: J-Link compiled Oct 20 2005 14:41:31 ARM Rev.5
Hardware: U5.00
S/N : 
VTarget = 0.0000
Speed set to 30 kHz
J-Link>
```

In the screenshot:

- The red box identifies the new firmware.
- The green box identifies the old firmware which has been replaced.

Chapter 12

Designing the target board for trace

This chapter describes the hardware requirements which have to be met by the target board.

12.1 Overview of high-speed board design

Failure to observe high-speed design rules when designing a target system containing an ARM Embedded Trace Macrocell (ETM) trace port can result in incorrect data being captured by J-Trace. You must give serious consideration to high-speed signals when designing the target system.

The signals coming from an ARM ETM trace port can have very fast rise and fall times, even at relatively low frequencies.

Note: These principles apply to all of the trace port signals (TRACEPKT[0:15], PIPESTAT[0:2], TRACESYNC), but special care must be taken with TRACECLK.

12.1.1 Avoiding stubs

Stubs are short pieces of track that tee off from the main track carrying the signal to, for example, a test point or a connection to an intermediate device. Stubs cause impedance discontinuities that affect signal quality and must be avoided.

Special care must therefore be taken when ETM signals are multiplexed with other pin functions and where the PCB is designed to support both functions with differing tracking requirements.

12.1.2 Minimizing Signal Skew (Balancing PCB Track Lengths)

You must attempt to match the lengths of the PCB tracks carrying all of TRACECLK, PIPESTAT, TRACESYNC, and TRACEPKT from the ASIC to the mictor connector to within approximately 0.5 inches (12.5mm) of each other. Any greater differences directly impact the setup and hold time requirements.

12.1.3 Minimizing Crosstalk

Normal high-speed design rules must be observed. For example, do not run dynamic signals parallel to each other for any significant distance, keep them spaced well apart, and use a ground plane and so forth. Particular attention must be paid to the TRACECLK signal. If in any doubt, place grounds or static signals between the TRACECLK and any other dynamic signals.

12.1.4 Using impedance matching and termination

Termination is almost certainly necessary, but there are some circumstances where it is not required. The decision is related to track length between the ASIC and the JTAG+Trace connector, see *Terminating the trace signal* on page 305 for further reference.

12.2 Terminating the trace signal

To terminate the trace signal, you can choose between three termination options:

- Matched impedance
- Series (source) termination
- DC parallel termination.

Matched impedance

Where available, the best termination scheme is to have the ASIC manufacturer match the output impedance of the driver to the impedance of the PCB track on your board. This produces the best possible signal.

Series (source) termination

This method requires a resistor fitted in series with signal. The resistor value plus the output impedance of the driver must be equal to the PCB track impedance.

DC parallel termination

This requires either a single resistor to ground, or a pull-up/pull-down combination of resistors (Thevenin termination), fitted at the end of each signal and as close as possible to the JTAG+Trace connector. If a single resistor is used, its value must be set equal to the PCB track impedance. If the pull-up/pull-down combination is used, their resistance values must be selected so that their parallel combination equals the PCB track impedance.

Caution:

At lower frequencies, parallel termination requires considerably more drive capability from the ASIC than series termination and so, in practice, DC parallel termination is rarely used.

12.2.1 Rules for series terminators

Series (source) termination is the most commonly used method. The basic rules are:

1. The series resistor must be placed as close as possible to the ASIC pin (less than 0.5 inches).
2. The value of the resistor must equal the impedance of the track minus the output impedance of the output driver. So for example, a 50 PCB track driven by an output with a 17 impedance, requires a resistor value of 33.
3. A source terminated signal is only valid at the end of the signal path. At any point between the source and the end of the track, the signal appears distorted because of reflections. Any device connected between the source and the end of the signal path therefore sees the distorted signal and might not operate correctly. Care must be taken not to connect devices in this way, unless the distortion does not affect device operation.

12.3 Signal requirements

The table below lists the specifications that apply to the signals as seen at the JTAG+Trace connector.

Signal	Value
Fmax	200MHz
Ts setup time (min.)	2.0ns
Th hold time (min.)	1.0ns
TRACECLK high pulse width (min.)	1.5ns
TRACECLK high pulse width (min.)	1.5ns

Table 12.1: Signal requirements

Chapter 13

Support and FAQs

This chapter contains troubleshooting tips together with solutions for common problems which might occur when using J-Link / J-Trace. There are several steps you can take before contacting support. Performing these steps can solve many problems and often eliminates the need for assistance. This chapter also contains a collection of frequently asked questions (FAQs) with answers.

13.1 Measuring download speed

13.1.1 Test environment

JLink.exe has been used for measurement performance. The hardware consisted of:

- PC with 2.6 GHz Pentium 4, running Win2K
- USB 2.0 port
- USB 2.0 hub
- J-Link
- Target with ARM7 running at 50MHz.

Below is a screenshot of JLink.exe after the measurement has been performed.

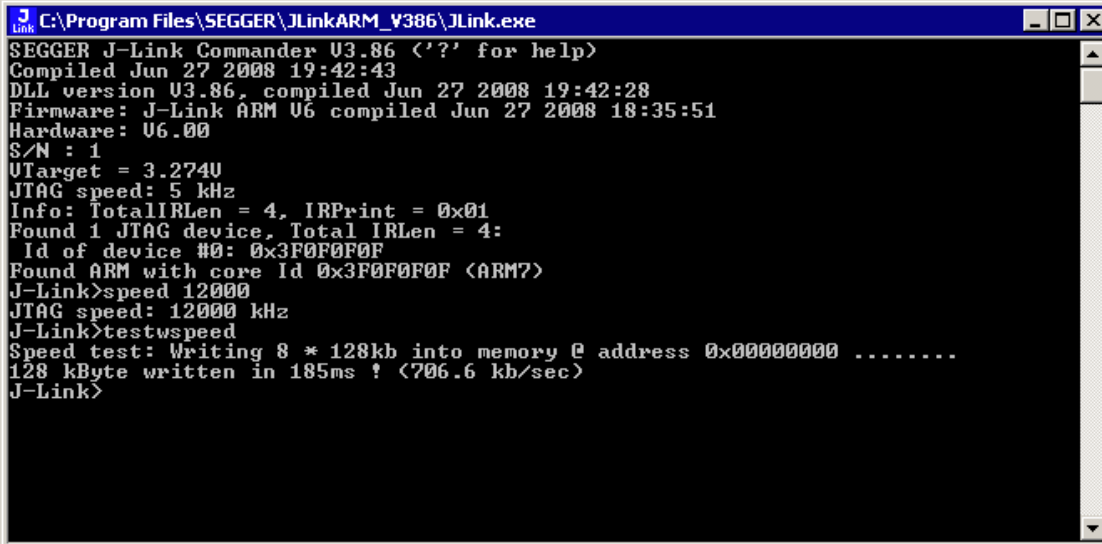

```
JLink C:\Program Files\SEGGER\JLinkARM_V386\JLink.exe
SEGGER J-Link Commander V3.86 <'?' for help>
Compiled Jun 27 2008 19:42:43
DLL version V3.86, compiled Jun 27 2008 19:42:28
Firmware: J-Link ARM V6 compiled Jun 27 2008 18:35:51
Hardware: V6.00
S/N : 1
VTarget = 3.274U
JTAG speed: 5 kHz
Info: TotalIRLen = 4, IRPrint = 0x01
Found 1 JTAG device, Total IRLen = 4:
  Id of device #0: 0x3F0F0F0F
Found ARM with core Id 0x3F0F0F0F <ARM7>
J-Link>speed 12000
JTAG speed: 12000 kHz
J-Link>testwspeed
Speed test: Writing 8 * 128kb into memory @ address 0x00000000 .....
128 kByte written in 185ms ! <706.6 kb/sec>
J-Link>
```

13.2 Troubleshooting

13.2.1 General procedure

If you experience problems with J-Link / J-Trace, you should follow the steps below to solve these problems:

1. Close all running applications on your host system.
2. Disconnect the J-Link / J-Trace device from USB.
3. Disable power supply on the target.
4. Re-connect J-Link / J-Trace with the host system (attach USB cable).
5. Enable power supply on the target.
6. Try your target application again. If the problem remains continue the following procedure.
7. Close all running applications on your host system again.
8. Disconnect the J-Link / J-Trace device from USB.
9. Disable power supply on the target.
10. Re-connect J-Link / J-Trace with the host system (attach the USB cable).
11. Enable power supply on the target.
12. Start `JLink.exe`.
13. If `JLink.exe` displays the J-Link / J-Trace serial number and the target processor's core ID, the J-Link / J-Trace is working properly and cannot be the cause of your problem.
14. If the problem persists and you own an original product (not an OEM version), see section *Contacting support* on page 311.

13.2.2 Typical problem scenarios

J-Link / J-Trace LED is off

Meaning:

The USB connection does not work.

Remedy:

Check the USB connection. Try to re-initialize J-Link / J-Trace by disconnecting and reconnecting it. Make sure that the connectors are firmly attached. Check the cable connections on your J-Link / J-Trace and the host computer. If this does not solve the problem, check if your cable is defect. If the USB cable is ok, try a different host computer.

J-Link / J-Trace LED is flashing at a high frequency

Meaning:

J-Link / J-Trace could not be enumerated by the USB controller.

Most likely reasons:

- a.) Another program is already using J-Link / J-Trace.
- b.) The J-Link USB driver does not work correctly.

Remedy:

- a.) Close all running applications and try to reinitialize J-Link / J-Trace by disconnecting and reconnecting it.
- b.) If the LED blinks permanently, check the correct installation of the J-Link USB driver. Deinstall and reinstall the driver as shown in chapter *Setup* on page 117.

J-Link/J-Trace does not get any connection to the target**Most likely reasons:**

- a.) The JTAG cable is defective.
- b.) The target hardware is defective.

Remedy:

Follow the steps described in *General procedure* on page 309.

13.3 Contacting support

Before contacting support, make sure you tried to solve your problem by following the steps outlined in section *General procedure* on page 309. You may also try your J-Link / J-Trace with another PC and if possible with another target system to see if it works there. If the device functions correctly, the USB setup on the original machine or your target hardware is the source of the problem, not J-Link / J-Trace.

If you need to contact support, send the following information to support@segger.com:

- A detailed description of the problem
- J-Link/J-Trace serial number
- Output of `JLink.exe` if available
- Your findings of the signal analysis
- Information about your target hardware (processor, board, etc.).

J-Link / J-Trace is sold directly by SEGGER or as OEM-product by other vendors. We can support only official SEGGER products.

13.4 Frequently Asked Questions

Supported CPUs

Q: Which CPUs are supported?

A: J-Link / J-Trace should work with any ARM7/9 and Cortex-M3 core. For a list of supported cores, see section *Supported CPU cores* on page 41.

Converting data files

Q: I want to download my application into flash memory using J-Link Commander but my application is a *.hex data file and J-Link Commander supports *.bin files only. How do I download it?

A: Please use the J-Flash (which is part of the J-Link software and documentation package) software to convert your *.hex/*.mot/... file to a *.bin file. For data file conversion, no J-Flash license is necessary.

Using J-Link in my application

Q: I want to write my own application and use J-Link / J-Trace. Is this possible?

A: Yes. We offer a dedicated Software Developer Kit (SDK). See section *J-Link Software Developer Kit (SDK)* on page 116 for further information.

Using DCC with J-Link

Q: Can I use J-Link / J-Trace to communicate with a running target via DCC?

A: Yes. The DLL includes functions to communicate via DCC on cores which support DCC, such as ARM7/9/11, Cortex A/R series.

Read status of JTAG pins

Q: Can J-Link / J-Trace read back the status of the JTAG pins?

A: Yes, the status of all pins can be read. This includes the outputs of J-Link / J-Trace as well as the supply voltage, which can be useful to detect hardware problems on the target system.

J-Link support of ETM

Q: Does J-Link support the Embedded Trace Macrocell (ETM)?

A: No. ETM requires another connection to the ARM chip and a CPU with built-in ETM. Most current ARM7 / ARM9 chips do not have ETM built-in.

J-Link support of ETB

Q: Does J-Link support the Embedded Trace Buffer (ETB)?

A: Yes. J-Link supports ETB. Most current ARM7 / ARM9 chips do not have ETB built-in.

Registers on ARM 7 / ARM 9 targets

Q: I'm running `J-Link.exe` in parallel to my debugger, on an ARM 7 target. I can read memory okay, but the processor registers are different. Is this normal?

A: If memory on an ARM 7/9 target is read or written the processor registers are modified. When memory read or write operations are performed, J-Link preserves the register values before they are modified. The register values shown in the debugger's register window are the preserved ones. If now a second instance, in this case `J-Link.exe`, reads the processor registers, it reads the values from the hardware, which are the modified ones. This is why it shows different register values.

Chapter 14

Glossary

This chapter describes important terms used throughout this manual.

Adaptive clocking

A technique in which a clock signal is sent out by J-Link / J-Trace. J-Link / J-Trace waits for the returned clock before generating the next clock pulse. The technique allows the J-Link / J-Trace interface unit to adapt to differing signal drive capabilities and differing cable lengths.

Application Program Interface

A specification of a set of procedures, functions, data structures, and constants that are used to interface two or more software components together.

Big-endian

Memory organization where the least significant byte of a word is at a higher address than the most significant byte. See Little-endian.

Cache cleaning

The process of writing dirty data in a cache to main memory.

Coprocessor

An additional processor that is used for certain operations, for example, for floating-point math calculations, signal processing, or memory management.

Dirty data

When referring to a processor data cache, data that has been written to the cache but has not been written to main memory is referred to as dirty data. Only write-back caches can have dirty data because a write-through cache writes data to the cache and to main memory simultaneously. See also cache cleaning.

Dynamic Linked Library (DLL)

A collection of programs, any of which can be called when needed by an executing program. A small program that helps a larger program communicate with a device such as a printer or keyboard is often packaged as a DLL.

Embedded Trace Macrocell (ETM)

ETM is additional hardware provided by debuggable ARM processors to aid debugging with trace functionality.

Embedded Trace Buffer (ETB)

ETB is a small, circular on-chip memory area where trace information is stored during capture.

EmbeddedICE

The additional hardware provided by debuggable ARM processors to aid debugging.

Halfword

A 16-bit unit of information. Contents are taken as being an unsigned integer unless otherwise stated.

Host

A computer which provides data and other services to another computer. Especially, a computer providing debugging services to a target being debugged.

ICache

Instruction cache.

ICE Extension Unit

A hardware extension to the EmbeddedICE logic that provides more breakpoint units.

ID

Identifier.

IEEE 1149.1

The IEEE Standard which defines TAP. Commonly (but incorrectly) referred to as JTAG.

Image

An executable file that has been loaded onto a processor for execution.

In-Circuit Emulator (ICE)

A device enabling access to and modification of the signals of a circuit while that circuit is operating.

Instruction Register

When referring to a TAP controller, a register that controls the operation of the TAP.

IR

See Instruction Register.

Joint Test Action Group (JTAG)

The name of the standards group which created the IEEE 1149.1 specification.

Little-endian

Memory organization where the least significant byte of a word is at a lower address than the most significant byte. See also Big-endian.

Memory coherency

A memory is coherent if the value read by a data read or instruction fetch is the value that was most recently written to that location. Obtaining memory coherency is difficult when there are multiple possible physical locations that are involved, such as a system that has main memory, a write buffer, and a cache.

Memory management unit (MMU)

Hardware that controls caches and access permissions to blocks of memory, and translates virtual to physical addresses.

Memory Protection Unit (MPU)

Hardware that controls access permissions to blocks of memory. Unlike an MMU, an MPU does not translate virtual addresses to physical addresses.

Multi-ICE

Multi-processor EmbeddedICE interface. ARM registered trademark.

RESET

Abbreviation of System Reset. The electronic signal which causes the target system other than the TAP controller to be reset. This signal is also known as "nSRST", "nSYSRST", "nRST", or "nRESET" in some other manuals. See also nTRST.

nTRST

Abbreviation of TAP Reset. The electronic signal that causes the target system TAP controller to be reset. This signal is known as nICERST in some other manuals. See also nSRST.

Open collector

A signal that may be actively driven LOW by one or more drivers, and is otherwise passively pulled HIGH. Also known as a "wired AND" signal.

Processor Core

The part of a microprocessor that reads instructions from memory and executes them, including the instruction fetch unit, arithmetic and logic unit, and the register bank. It excludes optional coprocessors, caches, and the memory management unit.

Program Status Register (PSR)

Contains some information about the current program and some information about the current processor state. Often, therefore, also referred to as Processor Status Register.

Also referred to as Current PSR (CPSR), to emphasize the distinction to the Saved PSR (SPSR). The SPSR holds the value the PSR had when the current function was called, and which will be restored when control is returned.

Remapping

Changing the address of physical memory or devices after the application has started executing. This is typically done to make RAM replace ROM once the initialization has been done.

Remote Debug Interface (RDI)

RDI is an open ARM standard procedural interface between a debugger and the debug agent. The widest possible adoption of this standard is encouraged.

RTCK

Returned TCK. The signal which enables Adaptive Clocking.

RTOS

Real Time Operating System.

Scan Chain

A group of one or more registers from one or more TAP controllers connected between TDI and TDO, through which test data is shifted.

Semihosting

A mechanism whereby the target communicates I/O requests made in the application code to the host system, rather than attempting to support the I/O itself.

SWI

Software Interrupt. An instruction that causes the processor to call a programmer-specified subroutine. Used by ARM to handle semihosting.

TAP Controller

Logic on a device which allows access to some or all of that device for test purposes. The circuit functionality is defined in IEEE1149.1.

Target

The actual processor (real silicon or simulated) on which the application program is running.

TCK

The electronic clock signal which times data on the TAP data lines TMS, TDI, and TDO.

TDI

The electronic signal input to a TAP controller from the data source (upstream). Usually, this is seen connecting the J-Link / J-Trace Interface Unit to the first TAP controller.

TDO

The electronic signal output from a TAP controller to the data sink (downstream). Usually, this is seen connecting the last TAP controller to the J-Link / J-Trace Interface Unit.

Test Access Port (TAP)

The port used to access a device's TAP Controller. Comprises TCK, TMS, TDI, TDO, and nTRST (optional).

Transistor-transistor logic (TTL)

A type of logic design in which two bipolar transistors drive the logic output to one or zero. LSI and VLSI logic often used TTL with HIGH logic level approaching +5V and LOW approaching 0V.

Watchpoint

A location within the image that will be monitored and that will cause execution to stop when it changes.

Word

A 32-bit unit of information. Contents are taken as being an unsigned integer unless otherwise stated.

Chapter 15

Literature and references

This chapter lists documents, which we think may be useful to gain deeper understanding of technical details.

Reference	Title	Comments
[ETM]	Embedded Trace Macrocell™ Architecture Specification, ARM IHI 0014J	This document defines the ETM standard, including signal protocol and physical interface. It is publicly available from ARM (www.arm.com).
[RVI]	RealView® ICE and RealView Trace User Guide, ARM DUI 0155C	This document describes ARM's realview ice emulator and requirements on the target side. It is publicly available from ARM (www.arm.com).

Table 15.1: Literature and References

Index

A		J-Link	
Adaptive clocking	314	Adapters	288
Application Program Interface	314	Developer Pack DLL	116
		Supported chips	188–189, 202–203
B		J-Link Commander	63
Big-endian	314	J-Link GDB Server	66
		J-Link RDI	112
C		J-Link STR9 Commander	113
Cache cleaning	314	J-Link TCP/IP Server	98
Coprocessor	314	J-Mem Memory Viewer	102
		Joint Test Action Group (JTAG)	315
D		JTAG	290
Dirty data	314	TAP controller	291
Dynamic Linked Library (DLL)	314	JTAGLoad	111
		L	
E		Little-endian	315
Embedded Trace Buffer (ETB)	297, 314		
Embedded Trace Macrocell (ETM) ..	293, 314	M	
EmbeddedICE	314	Memory coherency	315
		Memory management unit (MMU)	315
G		Memory Protection Unit (MPU)	315
General Query Packets	84	Multi-ICE	315
		N	
H		nTRST	274, 315
Halfword	314	O	
Host	314	Open collector	315
		P	
I		Processor Core	316
ICache	314	Program Status Register (PSR)	316
ICE Extension Unit	314		
ID	315	R	
IEEE 1149.1	315	RDI Support	112
Image	315	Remapping	316
In-Circuit Emulator	315	Remote Debug Interface (RDI)	316
Instruction Register	315	RESET	315
IR	315	RTCK	316
		RTOS	316
J			
J-Flash ARM	103		

S

Scan Chain	316
Semihosting	316
Server command	
clrbp	74
cp15	74
DisableChecks	74
EnableChecks	75
flash breakpoints	75
go	75
halt	76
jtagconf	76
memU16	77
memU8	76
reg	77
reset	78
setBP	78–80
sleep	81
speed	81
step	81
waithalt	83
wice	83
SetDbgPowerDownOnClose	180
SetSysPowerDownOnIdle	180
STRACE	85
Support	307, 313
Supported flash devices	190–191, 197, 204
SWI	316

T

Tabs	153
TAP Controller	316
Target	316
TCK	274, 316
TDI	274, 316
TDO	274, 317
Test Access Port (TAP)	317
Transistor-transistor logic (TTL)	317

W

Watchpoint	317
Word	317

X-ON Electronics

Largest Supplier of Electrical and Electronic Components

Click to view similar products for [segger microcontroller manufacturer](#):

Other Similar products are found below :

[SD Card Adapter](#) [J-Link RX Adapter](#) [8.06.03](#) [5.16.01](#) [FLASHER PORTABLE](#) [5.50.01.US](#) [US POWER ADAPTER FOR FLASHER 5/ST7](#)
[5.17.01](#) [8.20.00](#) [6.68.18](#) [8.06.17](#) [J-Link ARM-14 Adapter](#) [8.06.13](#) [6.32.32](#) [6.30.00](#) [6.68.20](#) [8.06.21](#) [8.07.10](#) [8.14.28](#) [8.06.14](#) [J-LINK](#)
[SUPPLY ADAPTER](#) [6.68.19](#) [8.06.24](#) [8.06.13](#) [J-LINK MEASUREMENT+PATCH ADAPTER](#) [5.09.01](#) [FLASHER STM8](#) [8.06.23](#) [6.37.04](#)
[6.37.01](#) [JTAG Isolator](#) [J-Link TI-CTI-20 Adapter](#) [8.06.18](#) [5.17.01](#) [FLASHER PRO](#) [8.06.09](#) [J-LINK MICROCHIP ADAPTER](#) [8.07.00](#) [JTAG](#)
[ISOLATOR](#) [8.06.05](#) [10-PIN NEEDLE ADAPTER](#) [6.90.00](#) [8.06.22](#) [8.06.25](#) [Flasher STM8](#) [8.06.26](#) [8.18.00](#) [8.06.05](#) [8.06.03](#) [J-LINK 14PIN](#)
[TIADAPTER](#) [8.06.06](#) [J-LINK TI CTI20ADAPTER](#) [5.16.02](#) [8.06.19](#) [5.07.01](#) [FLASHER ARM](#) [J-Link PRO](#) [8.06.28](#) [Flasher ARM](#) [J-Link](#)
[ULTRA+](#) [8.16.28](#) [J-LINK ULTRA+](#) [8.19.28](#)