

### APPLICATIONS

- Cell Phone Handsets and Accessories.
- Microprocessor based equipment.
- Personal Digital Assistants(PDA's)
- Notebooks Instrumentation.
- Peripherals.
- USB Interface.

### MECHANICAL CHARACTERISTICS

- JEDEC SOD-323 Package.
- Molding Compound Flammability Rating: UL 94V-O.
- Weight 5 Milligrams (Approximate).
- Quantity per Reel: 3000pcs.
- Reel Size: 7inch.
- Lead Finish: Lead Free.

### IEC COMPATIBILITY

- IEC61000-4-2(ESD)  $\pm 15\text{KV}$ (air),  $\pm 8\text{KV}$ (contact).
- IEC61000-4-4(EFT) 40A (5/50ns).
- IEC61000-4-5(Lightning) 12A (8/20 $\mu\text{s}$ ).

### FEATURES

- 350 Watts Peak Pulse Power per Line ( $t_p=8/20\mu\text{s}$ ).
- Protect one I/O lines (bidirectional).
- Low clamping voltage.
- Working voltages: 3V; 5V; 8V; 12V; 15V; 24V
- Low leakage current.

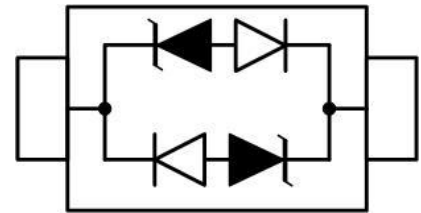
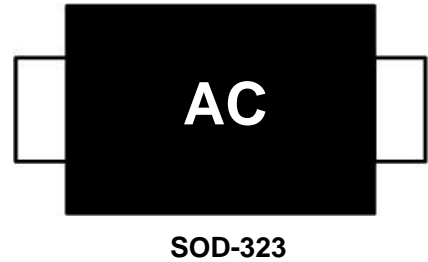

PIN CONFIGURATION

### DEVICE CHARACTERISTICS

MAXIMUM RATINGS (@25°C Unless Otherwise Specified)			
PARAMETER	SYMBOL	VALUE	UNITS
Peak Pulse Power (tp=8/20μs waveform)	P <sub>PP</sub>	350	Watts
Lead Soldering Temperature	T <sub>L</sub>	260 (10sec)	°C
Operating Temperature Range	T <sub>J</sub>	-55 to + 175	°C
Storage Temperature Range	T <sub>STG</sub>	-55 to + 175	°C

### ELECTRICAL CHARACTERISTICS PER LINE (@25°C Unless Otherwise Specified)

PART NUMBER	V <sub>RWM</sub> (V) (max.)	V <sub>B</sub> (V) (min.)	I <sub>T</sub> (mA)	V <sub>C</sub> (V) @5A (max.)	V <sub>C</sub> (V) (max.)(@A)	I <sub>R</sub> (μA) @ V <sub>RWM</sub> (max.)	C <sub>T</sub> (pF) (typ)	
SB05DLC-B	5.0	6.0	1	9.80	18.3	8	5	0.4

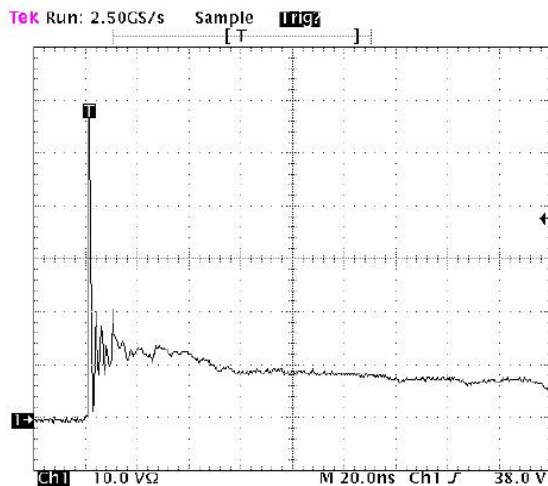

Figure 1. ESD Clamping Voltage Screenshot  
Positive 8 kV contact per IEC 61000-4-2

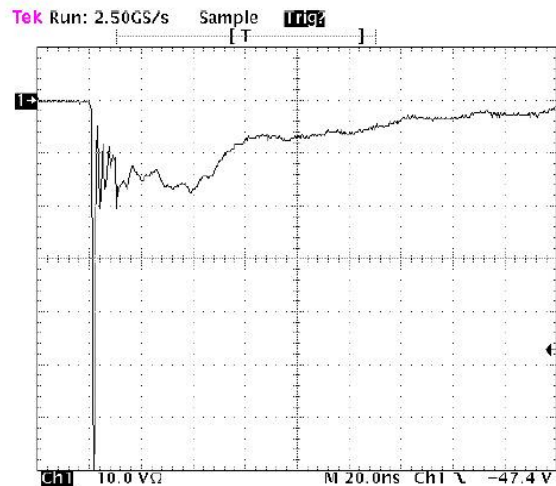
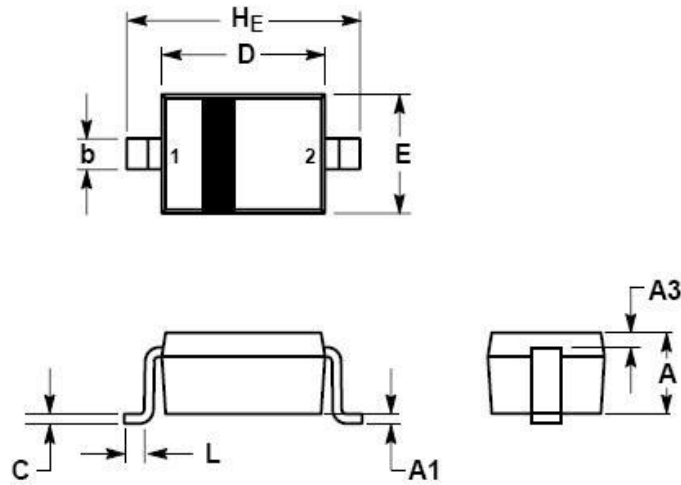

Figure 2. ESD Clamping Voltage Screenshot  
Negative 8 kV contact per IEC 61000-4-2

**SOD-323 PACKAGE OUTLINE & DIMENSIONS**



DIM	MILLIMETERS			INCHES		
	MIN	NOM	MAX	MIN	NOM	MAX
A	0.80	0.90	1.00	0.031	0.035	0.040
A1	0.00	0.05	0.10	0.000	0.002	0.004
A3	0.15REF			0.006REF		
b	0.25	0.32	0.4	0.010	0.012	0.016
C	0.089	0.12	0.177	0.003	0.005	0.007
D	1.60	1.70	1.80	0.062	0.066	0.070
E	1.15	1.25	1.35	0.045	0.049	0.053
L	0.08			0.003		
HE	2.30	2.50	2.70	0.090	0.098	0.105

**SOD-323 EMBOSSED CARRIER TAPE**

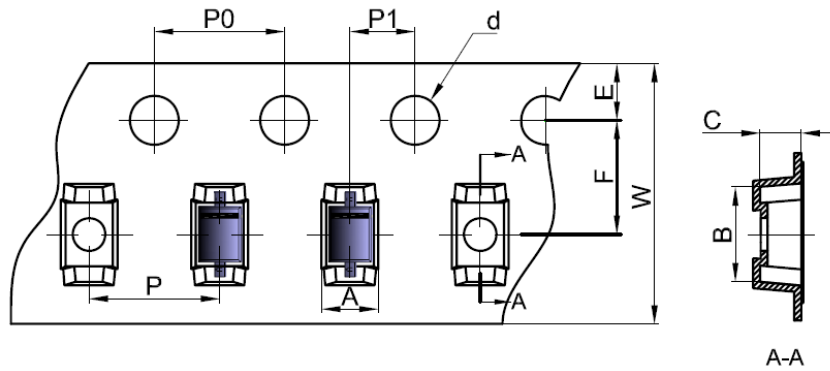

PKG TYPE	A	B	C	d	E	F	PO	P	P1	W
SOD-323	1.46	2.90	1.25	Φ1.50	1.75	3.50	4.00	4.00	2.00	8.00
TOLERANCE	±0.05	±0.05	±0.05	±0.10	±0.10	±0.10	±0.10	±0.10	±0.10	+0.3-0.1

**TAPE LEADER AND TRAILER**

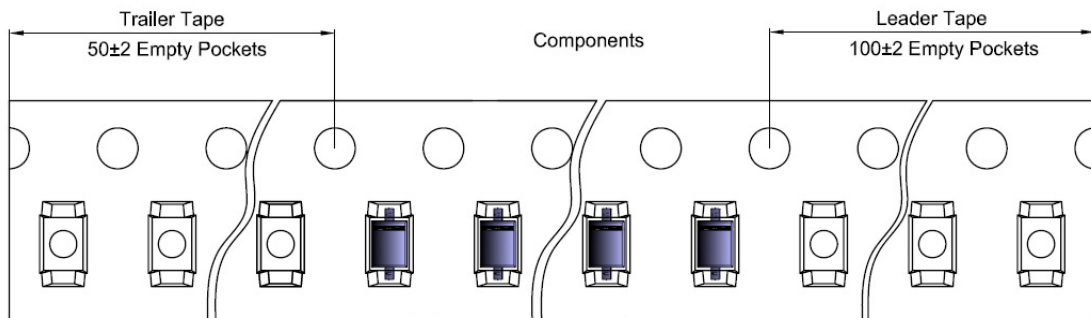

**REEL**

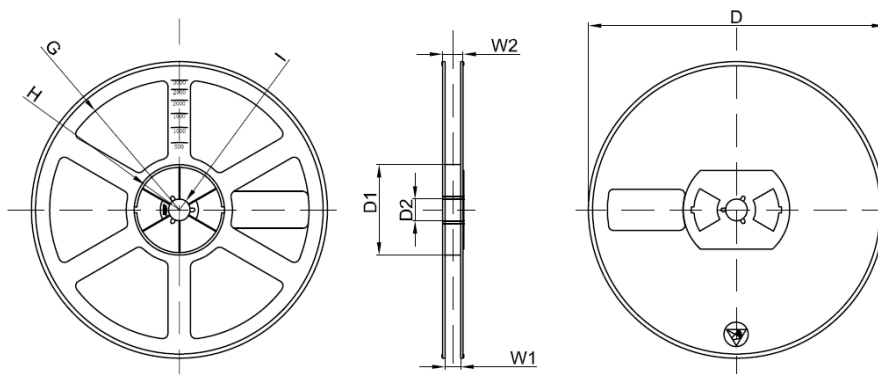

Dimension in Millimeter								
REEL OPTION	D	D1	D2	G	H	I	W1	W2
7"DIAMETION	Φ178	54.40	13.00	R78.0	R25.60	R6.50	9.50	12.30
TOLERANCE	±2	±1	±1	±1	±1	±1	±1	±1

### SOLDERING FOOTPRINT

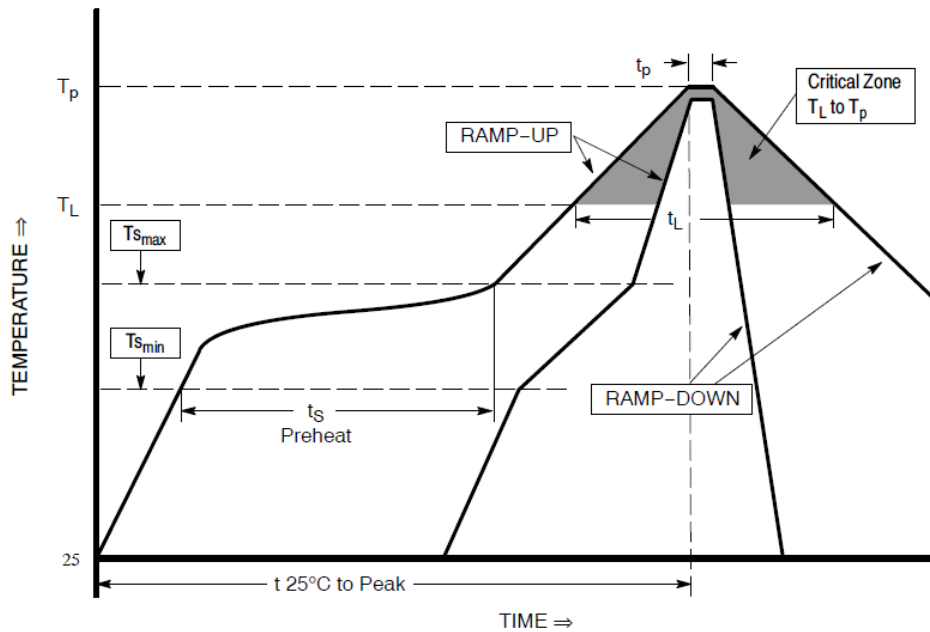
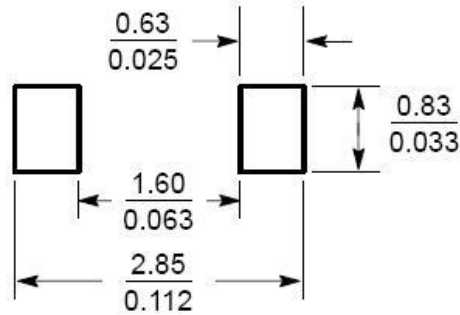

Profile Feature	Pb-Free Assembly
Average Ramp-Up Rate( $T_{smax}$ to $T_p$ )	3°C/Second max
Preheat Temperature Min( $T_{smin}$ ) Temperature Max( $T_{smax}$ ) Time( $t_{smin}$ to $t_{smax}$ )	150°C 200°C 60-180 seconds
Time maintained above Temperature( $T_t$ ) Time( $t_T$ )	217°C 60-150 seconds
Peak Classification Temperature( $T_p$ )	260°C +5/-0
Time within 5°C of actual Peak Temperature( $t_p$ )	20-40seconds
Ramp-Down Rate	6°C /second max
Time 25°C to Peak Temperature	8 minutes max

## X-ON Electronics

Largest Supplier of Electrical and Electronic Components

*Click to view similar products for [ESD Suppressors / TVS Diodes](#) category:*

*Click to view products by [SEMBO](#) manufacturer:*

Other Similar products are found below :

[60KS200C](#) [D18V0L1B2LP-7B](#) [D5V0F4U5P5-7](#) [DESD5V0U1BB-7](#) [NTE4902](#) [P4KE27CA](#) [P6KE11CA](#) [P6KE39CA-TP](#) [P6KE8.2A](#)  
[SA110CA](#) [SA60CA](#) [SA64CA](#) [SMBJ12CATR](#) [SMBJ33CATR](#) [SMBJ8.0A](#) [ESD101-B1-02ELS E6327](#) [ESD105-B1-02EL E6327](#) [ESD112-B1-02EL E6327](#) [ESD119B1W01005E6327XTSA1](#) [ESD5V0L1B02VH6327XTSA1](#) [ESD7451N2T5G](#) [19180-510](#) [CPDT-5V0USP-HF](#)  
[3.0SMCJ33CA-F](#) [3.0SMCJ36A-F](#) [HSPC16701B02TP](#) [D3V3Q1B2DLP3-7](#) [D55V0M1B2WS-7](#) [DESD5V0U1BL-7B](#) [DRTR5V0U4SL-7](#)  
[SCM1293A-04SO](#) [ESD200-B1-CSP0201 E6327](#) [SM12-7](#) [SMLJ45CA-TP](#) [CEN955 W/DATA](#) [82350120560](#) [VESD12A1A-HD1-GS08](#)  
[CPDUR5V0R-HF](#) [CPDQC5V0U-HF](#) [CPDQC5V0USP-HF](#) [CPDQC5V0-HF](#) [D1213A-01LP4-7B](#) [D1213A-02WL-7](#) [MMAD1108/TR13](#)  
[5KP100A](#) [5KP15A](#) [5KP18A](#) [5KP48A](#) [5KP90A](#) [5KP90CA](#)