

FEATURES

- For surface mounted application
- Low profile package
- Built-in strain relief
- Glass passivated junction
- Excellent clamping capability
- Fast response time: Typically less than 1.0ps from 0 volt to V_{BRmin} .
- Typical I_R less than $1\mu A$ above 10V.
- High temperature soldering guaranteed:260°C/ 40 seconds at terminals
- Plastic package has Underwriters Laboratory Flammability Classification 94V-0
- 400 watts peak pulse power capability with a 10 x 1000 uswaveform by 0.01% duty cycle



SMA(DO-214AC)

MECHANICAL DATA

- Case: Molded plastic
- Terminals: Solder plated
- Polarity: Indicated by cathode band
- Standard packaging: 12mm tape (EIA STD RS-481)
- Weight:0.002 ounce, 0.061gram

DEVICES FOR BIPOLAR APPLICATION

For bidirectional use C or CA suffix for types SMAJ5.0 thru types SMAJ440 (e.g.SMAJ5.0CA, SMAJ440CA),electrical characteristics apply in both directions.

MAXIMUM RATINGS AND CHARACTERISTICS

Ratings at 25 ambient temperature unless otherwise specified.

Type Number	Symbol	Value	Units
Peak Power Dissipation at $T_A=25^{\circ}C$, $T_p=1ms$ (Note 1)	P_{PPM}	Minimum 400	Watts
Peak Forward Surge Current, 8.3 ms Single Half Sine-wave Superimposed on Rated Load (JEDEC method) (Note 2, 3) - Unidirectional Only	I_{FSM}	40	Amps
Maximum Instantaneous Forward Voltage at 25A for Unidirectional Only	V_F	3.5/5.0	Volts
Operating and Storage Temperature Range	T_J, T_{STG}	-65 to + 150	$^{\circ}C$

Notes: 1. Non-repetitive Current Pulse Per Fig. 3 and Derated above $T_A=25^{\circ}C$ Per Fig. 2.
 2. Mounted on 5.0mm² (.013 mm Thick) Copper Pads to Each Terminal.
 3. 8.3ms Single Half Sine-wave or Equivalent Square Wave, Duty Cycle=4 pulses Per Minute Maximum.

PACKAGE DIMENSIONS

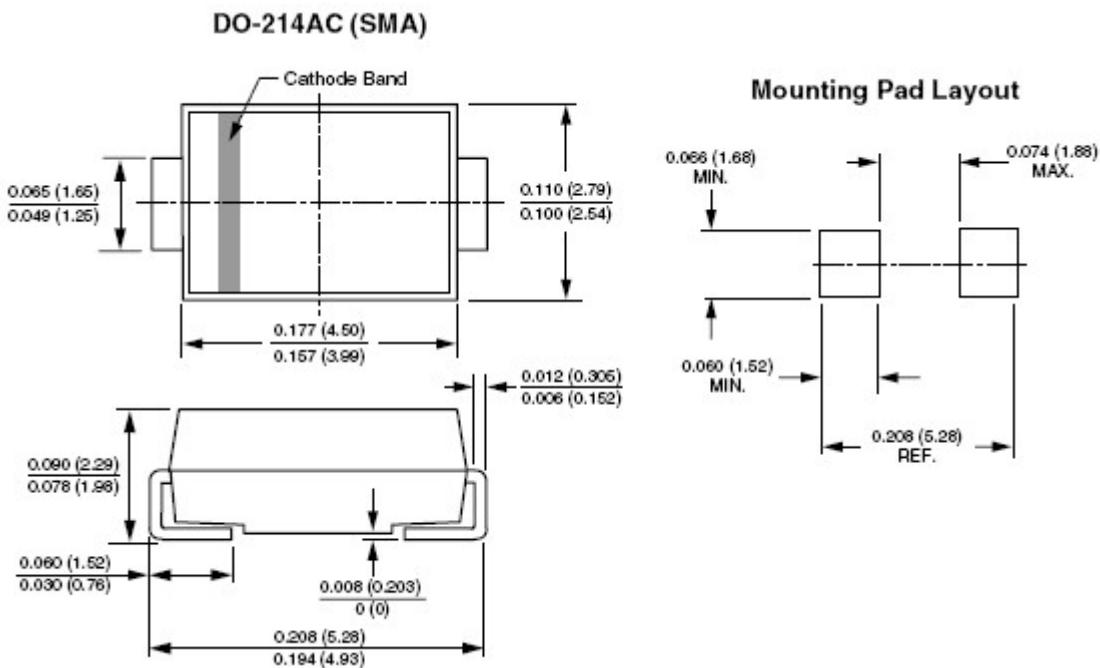

ELECTRICAL CHARACTERISTICS

Part Number		Marking code		Reverse Stand-Off Voltage	Breakdown Voltage @IT		Test Current	Maximum Clamping Voltage @IPP	Peak Pulse Current	Reverse Leakage @VRWM
(UNI)	(BI)	(UNI)	(BI)	VRWM(V)	VBR MIN.(V)	VBR MAX.(V)	IT(mA)	VC(V)	IPP(A)	IR(μA)
SMAJ5.0A	SMAJ5.0CA	HE	TE	5.0	6.40	7.25	10	9.2	43.5	800
SMAJ6.0A	SMAJ6.0CA	HG	TG	6.0	6.67	7.67	10	10.3	38.8	800
SMAJ6.5A	SMAJ6.5CA	HK	TK	6.5	7.22	8.30	10	11.2	35.7	500
SMAJ7.0A	SMAJ7.0CA	HM	TM	7.0	7.78	8.95	1	12	33.3	200
SMAJ7.5A	SMAJ7.5CA	HP	TP	7.5	8.33	9.58	1	12.9	31.0	100
SMAJ8.0A	SMAJ8.0CA	HR	TR	8.0	8.89	10.23	1	13.6	29.4	50
SMAJ8.5A	SMAJ8.5CA	HT	TT	8.5	9.44	10.82	1	14.4	27.8	20
SMAJ9.0A	SMAJ9.0CA	HV	TV	9.0	10.00	11.50	1	15.4	26.0	10
SMAJ10A	SMAJ10CA	HX	TX	10.0	11.10	12.80	1	17	23.5	5

Part Number		Marking code		Reverse Stand-Off Voltage	Breakdown Voltage @IT		Test Current	Maximum Clamping Voltage @IPP	Peak Pulse Current	Reverse Leakage @VRWM
(UNI)	(BI)	(UNI)	(BI)	VRWM(V)	VBR MIN.(V)	VBR MAX.(V)	IT(mA)	VC(V)	IPP(A)	IR(μA)
SMAJ11A	SMAJ11CA	HZ	TZ	11.0	12.20	14.00	1	18.2	22.0	1
SMAJ12A	SMAJ12CA	IE	UE	12.0	13.30	15.30	1	19.9	20.1	1
SMAJ13A	SMAJ13CA	IG	UG	13.0	14.40	16.50	1	21.5	18.6	1
SMAJ14A	SMAJ14CA	IK	UK	14.0	15.60	17.90	1	23.2	17.2	1
SMAJ15A	SMAJ15CA	IM	UM	15.0	16.70	19.20	1	24.4	16.4	1
SMAJ16A	SMAJ16CA	IP	UP	16.0	17.80	20.50	1	26	15.4	1
SMAJ17A	SMAJ17CA	IR	UR	17.0	18.90	21.70	1	27.6	14.5	1
SMAJ18A	SMAJ18CA	IT	UT	18.0	20.00	23.30	1	29.2	13.7	1
SMAJ20A	SMAJ20CA	IV	UV	20.0	22.20	25.50	1	32.4	12.3	1
SMAJ22A	SMAJ22CA	IX	UX	22.0	24.40	28.00	1	35.5	11.3	1
SMAJ24A	SMAJ24CA	IZ	UZ	24.0	26.70	30.70	1	38.9	10.3	1
SMAJ26A	SMAJ26CA	JE	VE	26.0	28.90	33.20	1	42.1	9.5	1
SMAJ28A	SMAJ28CA	JG	VG	28.0	31.10	35.80	1	45.2	8.8	1
SMAJ30A	SMAJ30CA	JK	VK	30.0	33.30	38.30	1	48.4	8.3	1
SMAJ33A	SMAJ33CA	JM	VM	33.0	36.70	42.20	1	53.3	7.5	1
SMAJ36A	SMAJ36CA	JP	VP	36.0	40.00	46.00	1	58.1	6.9	1
SMAJ40A	SMAJ40CA	JR	VR	40.0	44.40	51.10	1	64.5	6.2	1
SMAJ43A	SMAJ43CA	JT	VT	43.0	47.80	54.90	1	69.4	5.8	1
SMAJ45A	SMAJ45CA	JV	VV	45.0	50.00	57.50	1	72.7	5.5	1
SMAJ48A	SMAJ48CA	JX	VX	48.0	53.30	61.30	1	77.4	5.2	1
SMAJ51A	SMAJ51CA	JZ	VZ	51.0	56.70	65.20	1	82.4	4.9	1
SMAJ54A	SMAJ54CA	RE	WE	54.0	60.00	69.00	1	87.1	4.6	1
SMAJ58A	SMAJ58CA	RG	WG	58.0	64.40	74.10	1	93.6	4.3	1
SMAJ60A	SMAJ60CA	RK	WK	60.0	66.70	76.70	1	96.8	4.1	1
SMAJ64A	SMAJ64CA	RM	WM	64.0	71.10	81.80	1	103	3.9	1
SMAJ70A	SMAJ70CA	RP	WP	70.0	77.80	89.50	1	113	3.5	1

Part Number		Marking code		Reverse Stand-Off Voltage	Breakdown Voltage @IT		Test Current	Maximum Clamping Voltage @IPP	Peak Pulse Current	Reverse Leakage @VRWM
(UNI)	(BI)	(UNI)	(BI)	VRWM(V)	VBR MIN.(V)	VBR MAX.(V)	IT(mA)	VC(V)	IPP(A)	IR(μ A)
SMAJ75A	SMAJ75CA	RR	WR	75.0	83.30	95.80	1	121	3.3	1
SMAJ78A	SMAJ78CA	RT	WT	78.0	86.70	99.70	1	126	3.2	1
SMAJ85A	SMAJ85CA	RV	WV	85.0	94.40	108.20	1	137	2.9	1
SMAJ90A	SMAJ90CA	RX	WX	90.0	100.00	115.50	1	146	2.7	1
SMAJ100A	SMAJ100CA	RZ	WZ	100.0	111.00	128.00	1	162	2.5	1
SMAJ110A	SMAJ110CA	SE	XE	110.0	122.00	140.50	1	177	2.3	1
SMAJ120A	SMAJ120CA	SG	XG	120.0	133.00	153.00	1	193	2.1	1
SMAJ130A	SMAJ130CA	SK	XK	130.0	144.00	165.50	1	209	1.9	1
SMAJ150A	SMAJ150CA	SM	XM	150.0	167.00	192.50	1	243	1.6	1
SMAJ160A	SMAJ160CA	SP	XP	160.0	178.00	205.00	1	259	1.5	1
SMAJ170A	SMAJ170CA	SR	XR	170.0	189.00	217.50	1	275	1.5	1
SMAJ180A	SMAJ180CA	ST	XT	180.0	201.00	230.40	1	292	1.4	1
SMAJ190A	SMAJ190CA	SV	XV	190.0	209.00	243.20	1	308	1.3	1
SMAJ200A	SMAJ200CA	SX	XX	200.0	224.00	256.00	1	324	1.2	1
SMAJ210A	SMAJ210CA	SZ	XZ	210.0	231.00	268.80	1	340	1.2	1
SMAJ220A	SMAJ220CA	ZE	YE	220.0	246.00	281.60	1	356	1.1	1
SMAJ250A	SMAJ250CA	ZG	YG	250.0	279.00	309.00	1	405	1.0	1
SMAJ300A	SMAJ300CA	ZK	YK	300.0	335.00	371.00	1	486	0.8	1
SMAJ350A	SMAJ350CA	ZM	YM	350.0	391.00	432.00	1	567	0.7	1
SMAJ400A	SMAJ400CA	ZP	YP	400.0	447.00	494.00	1	648	0.6	1
SMAJ440A	SMAJ440CA	ZR	YR	440.0	492.00	543.00	1	713	0.6	1

PACKAGING

Part Number	Component Package	Quantity
SMAJxxxXX	DO-214AC	2000

☎400-700-8166

<http://www.sembo.com.cn>
<http://www.china-sembo.com>

RATINGS AND CHARACTERISTIC CURVES (TA=25 unless

otherwise noted)

FIG.1 - PEAK PULSE POWER RATING CURVE

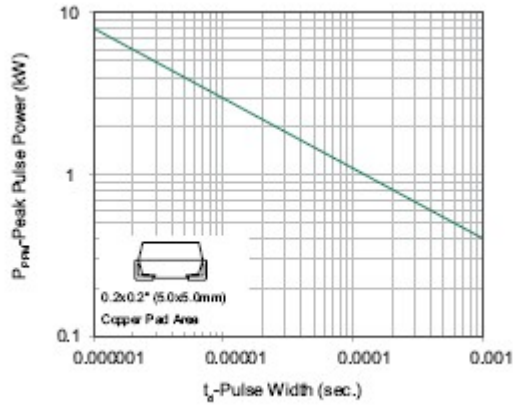

FIG.2 - PULSE DERATING CURVE

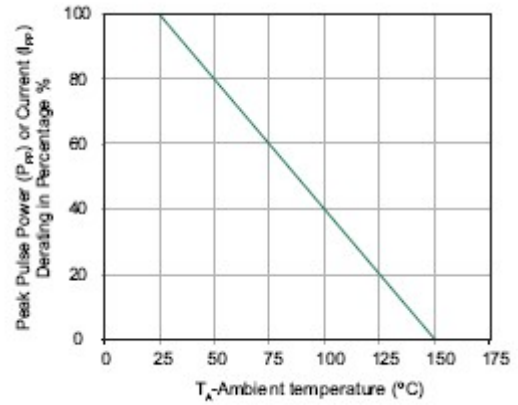

FIG.3 - PULSE WAVEFORM

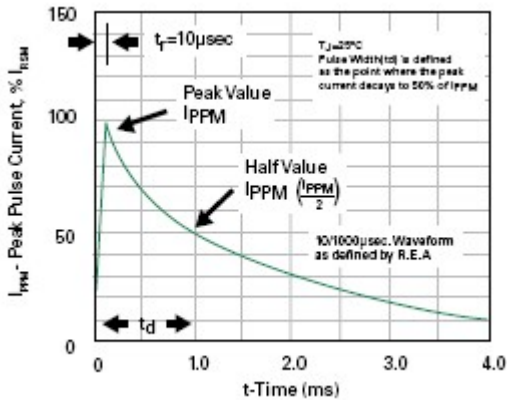

FIG.4 - TYPICAL JUNCTION CAPACITANCE

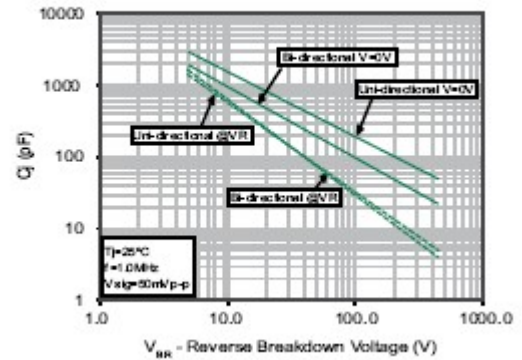

FIG.5 - STEADY STATE POWER DISSIPATION DERATING CURVE

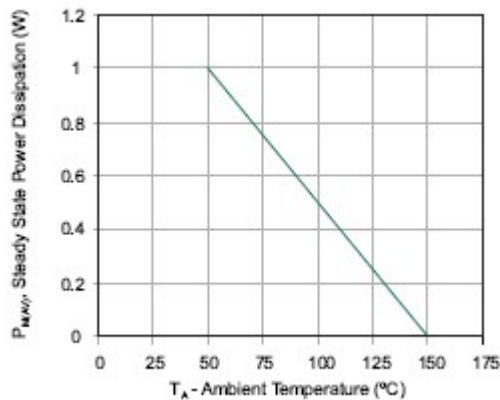
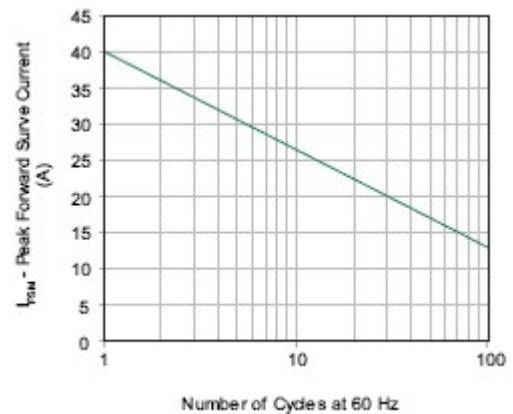

FIG.6 - MAXIMUM NON-REPETITIVE FORWARD SURGE CURRENT UNI-DIRECTIONAL ONLY



X-ON Electronics

Largest Supplier of Electrical and Electronic Components

Click to view similar products for [ESD Suppressors / TVS Diodes category](#):

Click to view products by [SEMBO manufacturer](#):

Other Similar products are found below :

[60KS200C](#) [D18V0L1B2LP-7B](#) [D5V0F4U5P5-7](#) [DESD5V0U1BB-7](#) [NTE4902](#) [P4KE27CA](#) [P6KE11CA](#) [P6KE39CA-TP](#) [P6KE8.2A](#)
[SA110CA](#) [SA60CA](#) [SA64CA](#) [SMBJ12CATR](#) [SMBJ33CATR](#) [SMBJ8.0A](#) [ESD101-B1-02ELS E6327](#) [ESD105-B1-02EL E6327](#) [ESD112-B1-02EL E6327](#) [ESD119B1W01005E6327XTSA1](#) [ESD5V0L1B02VH6327XTSA1](#) [ESD7451N2T5G](#) [19180-510](#) [CPDT-5V0USP-HF](#)
[3.0SMCJ33CA-F](#) [3.0SMCJ36A-F](#) [HSPC16701B02TP](#) [D3V3Q1B2DLP3-7](#) [D55V0M1B2WS-7](#) [DESD5V0U1BL-7B](#) [DRTR5V0U4SL-7](#)
[SCM1293A-04SO](#) [ESD200-B1-CSP0201 E6327](#) [SM12-7](#) [SMF8.0A-TP](#) [SMLJ45CA-TP](#) [SMQA1000T1G](#) [CEN955 W/DATA](#) [82350120560](#)
[VESD12A1A-HD1-GS08](#) [CPDUR5V0R-HF](#) [CPDQC5V0U-HF](#) [CPDQC5V0USP-HF](#) [CPDQC5V0-HF](#) [IP4042CX5/LF,135](#) [D1213A-01LP4-7B](#) [D1213A-02WL-7](#) [1SMB33CAT3G-XYZ](#) [MMAD1108/TR13](#) [5KP100A](#) [5KP15A](#)