

FEATURES

- For surface mounted application
- Low profile package
- Built-in strain relief
- Glass passivated junction
- Excellent clamping capability
- Fast response time: Typically less than 1.0ps from 0 volt to BV min.
- Typical less than 1 , -4;0'
- High temperature soldering guaranteed:250°C/ 10 seconds at terminals
- Plastic package has Underwriters Laboratory Flammability Classification 94V-0
- 600 watts peak pulse power capability with a 10 x 1000 us waveform by 0.01% duty cycle



SMB(DO-214AA)

MECHANICAL DATA

- Case: Molded plastic
- Terminals: Solder plated
- Polarity: Indicated by cathode band
- Standard packaging: 12mm tape (EIA STD RS-481)
- Weight: 0.003 ounce 0.093grams

DEVICES FOR BIPOLAR APPLICATION

For bidirectional use C or CA suffix for types SMBJ5.0 thru types SMBJ440 (e.g.SMBJ5.0CA, SMBJ440CA),electrical characteristics apply in both directions.

MAXIMUM RATINGS AND CHARACTERISTICS

Ratings at 25 ambient temperature unless otherwise specified.

Type Number	Symbol	Value	Units
Peak Power Dissipation at TA=25°C, Tp=1ms(Note 1)	P _{PPM}	Minimum 600	Watts
Peak Forward Surge Current, 8.3 ms Single Half Sine-wave Superimposed on Rated Load (JEDEC method) (Note 2, 3) - Unidirectional Only	I _{FSM}	100	Amps
Maximum Instantaneous Forward Voltage at 50.0A for Unidirectional Only	V _F	3.5 / 5.0	Volts
Operating and Storage Temperature Range	T _J , T _{STG}	-65 to + 150	°C

Notes: 1. Non-repetitive Current Pulse Per Fig. 3 and Derated above TA=25°C Per Fig. 2.

2. Mounted on 5.0mm² (.013 mm Thick) Copper Pads to Each Terminal.

3. 8.3ms Single Half Sine-wave or Equivalent Square Wave, Duty Cycle=4 pulses Per Minute Maximum.

PACKAGE DIMENSIONS

DO-214AA (SMB-J-Bend)

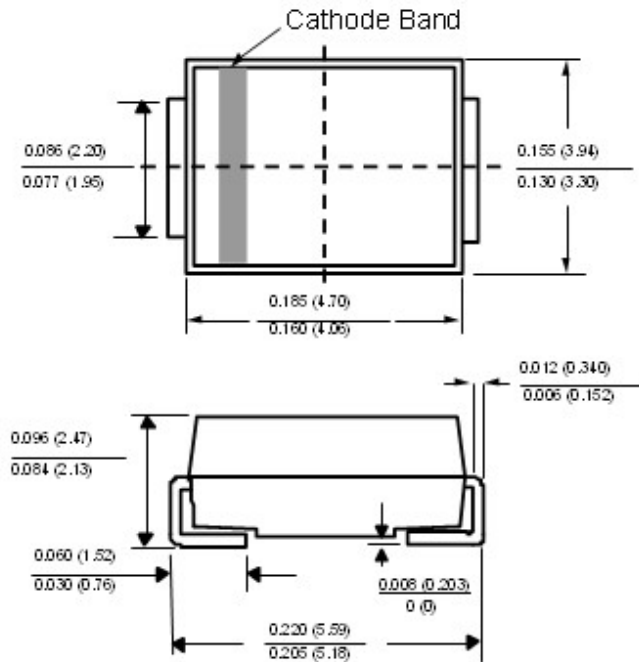

Mounting Pad Layout

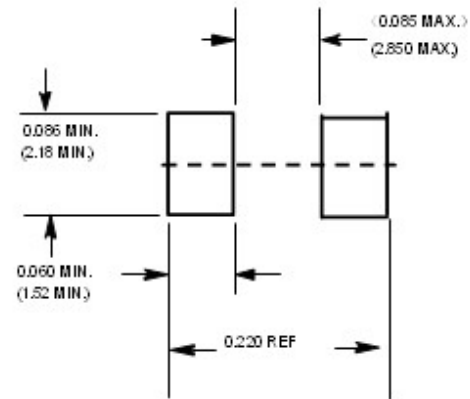

ELECTRICAL CHARACTERISTICS

Part Number		Marking code		Reverse Stand-Off Voltage	Breakdown Voltage @IT		Test Current	Maximum Clamping Voltage @IPP	Peak Pulse Current	Reverse Leakage @VRWM
(UNI)	(BI)	(UNI)	(BI)	VRWM(V)	VBR MIN.(V)	VBR MAX.(V)	IT(mA)	VC(V)	IPP(A)	IR(μA)
SMBJ5.0A	SMBJ5.0CA	KE	AE	5.0	6.40	7.25	10	9.20	65.30	800
SMBJ6.0A	SMBJ6.0CA	KG	AG	6.0	6.67	7.67	10	10.30	58.30	800
SMBJ6.5A	SMBJ6.5CA	KK	AK	6.5	7.22	8.30	10	11.20	53.60	500
SMBJ7.0A	SMBJ7.0CA	KM	AM	7.0	7.78	8.95	10	12.00	50.00	200
SMBJ7.5A	SMBJ7.5CA	KP	AP	7.5	8.33	9.58	1	12.90	46.60	100
SMBJ8.0A	SMBJ8.0CA	KR	AR	8.0	8.89	10.23	1	13.60	44.20	50
SMBJ8.5A	SMBJ8.5CA	KT	AT	8.5	9.44	10.82	1	14.40	41.70	20
SMBJ9.0A	SMBJ9.0CA	KV	AV	9.0	10.00	11.50	1	15.40	39.00	10
SMBJ10A	SMBJ10CA	KX	AX	10.0	11.10	12.80	1	17.00	35.30	5

Part Number		Marking code		Reverse Stand-Off Voltage	Breakdown Voltage @IT		Test Current	Maximum Clamping Voltage @IPP	Peak Pulse Current	Reverse Leakage @VRWM
(UNI)	(BI)	(UNI)	(BI)	VRWM(V)	VBR MIN.(V)	VBR MAX.(V)	IT(mA)	VC(V)	IPP(A)	IR(μA)
SMBJ11A	SMBJ11CA	KZ	AZ	11.0	12.20	14.00	1	18.20	33.00	1
SMBJ12A	SMBJ12CA	LE	BE	12.0	13.30	15.30	1	19.90	30.20	1
SMBJ13A	SMBJ13CA	LG	BG	13.0	14.40	16.50	1	21.50	28.00	1
SMBJ14A	SMBJ14CA	LK	BK	14.0	15.60	17.90	1	23.20	25.90	1
SMBJ15A	SMBJ15CA	LM	BM	15.0	16.70	19.20	1	24.40	24.60	1
SMBJ16A	SMBJ16CA	LP	BP	16.0	17.80	20.50	1	26.00	23.10	1
SMBJ17A	SMBJ17CA	LR	BR	17.0	18.90	21.70	1	27.60	21.70	1
SMBJ18A	SMBJ18CA	LT	BT	18.0	20.00	23.30	1	29.20	20.50	1
SMBJ20A	SMBJ20CA	LV	BV	20.0	22.20	25.50	1	32.40	18.50	1
SMBJ22A	SMBJ22CA	LX	BX	22.0	24.40	28.00	1	35.50	16.90	1
SMBJ24A	SMBJ24CA	LZ	BZ	24.0	26.70	30.70	1	38.90	15.20	1
SMBJ26A	SMBJ26CA	ME	CE	26.0	28.90	33.20	1	42.10	14.20	1
SMBJ28A	SMBJ28CA	MG	CG	28.0	31.10	35.80	1	45.20	13.20	1
SMBJ30A	SMBJ30CA	MK	CK	30.0	33.30	38.30	1	48.40	12.40	1
SMBJ33A	SMBJ33CA	MM	CM	33.0	36.70	42.20	1	53.3	11.30	1
SMBJ36A	SMBJ36CA	MP	CP	36.0	40.00	46.00	1	58.10	10.30	1
SMBJ40A	SMBJ40CA	MR	CR	40.0	44.40	51.10	1	64.50	9.30	1
SMBJ43A	SMBJ43CA	MT	CT	43.0	47.80	54.90	1	69.40	8.60	1
SMBJ45A	SMBJ45CA	MV	CV	45.0	50.00	57.50	1	72.70	8.30	1
SMBJ48A	SMBJ48CA	MX	CX	48.0	53.30	61.30	1	77.40	7.70	1
SMBJ51A	SMBJ51CA	MZ	CZ	51.0	56.70	65.20	1	82.40	7.30	1
SMBJ54A	SMBJ54CA	NE	DE	54.0	60.00	69.00	1	87.10	6.90	1
SMBJ58A	SMBJ58CA	NG	DG	58.0	64.40	74.10	1	93.60	6.40	1
SMBJ60A	SMBJ60CA	NK	DK	60.0	66.70	76.70	1	96.80	6.20	1
SMBJ64A	SMBJ64CA	NM	DM	64.0	71.10	81.80	1	103.00	5.80	1
SMBJ70A	SMBJ70CA	NP	DP	70.0	77.80	89.50	1	113.00	5.30	1

Part Number		Marking code		Reverse Stand-Off Voltage	Breakdown Voltage @IT		Test Current	Maximum Clamping Voltage @IPP	Peak Pulse Current	Reverse Leakage @VRWM
(UNI)	(BI)	(UNI)	(BI)	VRWM(V)	VBR MIN.(V)	VBR MAX.(V)	IT(mA)	VC(V)	IPP(A)	IR(μA)
SMBJ75A	SMBJ75CA	NR	DR	75.0	83.30	95.80	1	121.00	4.90	1
SMBJ78A	SMBJ78CA	NT	DT	78.0	86.70	99.70	1	126.00	4.70	1
SMBJ85A	SMBJ85CA	NV	DV	85.0	94.40	108.20	1	137.00	4.40	1
SMBJ90A	SMBJ90CA	NX	DX	90.0	100.00	115.50	1	146.00	4.10	1
SMBJ100A	SMBJ100CA	NZ	DZ	100.0	111.00	128.00	1	162.00	3.70	1
SMBJ110A	SMBJ110CA	PE	EE	110.0	122.00	140.50	1	177.00	3.40	1
SMBJ120A	SMBJ120CA	PG	EG	120.0	133.00	153.00	1	193.00	3.10	1
SMBJ130A	SMBJ130CA	PK	EK	130.0	144.00	165.50	1	209.00	2.90	1
SMBJ150A	SMBJ150CA	PM	EM	150.0	167.00	192.50	1	243.00	2.50	1
SMBJ160A	SMBJ160CA	PP	EP	160.0	178.00	205.00	1	259.00	2.30	1
SMBJ170A	SMBJ170CA	PR	ER	170.0	189.00	217.50	1	275.00	2.20	1
SMBJ180A	SMBJ180CA	PT	ET	180.0	201.00	230.40	1	292.00	2.10	1
SMBJ190A	SMBJ190CA	PV	EV	190.0	209.00	243.20	1	308.00	2.00	1
SMBJ200A	SMBJ200CA	PX	EX	200.0	224.00	256.00	1	324.00	1.90	1
SMBJ210A	SMBJ210CA	PZ	EZ	210.0	231.00	268.80	1	340.00	1.80	1
SMBJ220A	SMBJ220CA	QE	FE	220.0	246.00	281.60	1	356.00	1.70	1
SMBJ250A	SMBJ250CA	QG	FG	250.0	279.00	309.00	1	405.00	1.50	1
SMBJ300A	SMBJ300CA	QK	FK	300.0	335.00	371.00	1	486.00	1.30	1
SMBJ350A	SMBJ350CA	QM	FM	350.0	391.00	432.00	1	567.00	1.10	1
SMBJ400A	SMBJ400CA	QP	FP	400.0	447.00	494.00	1	648.00	0.90	1
SMBJ440A	SMBJ440CA	QR	FR	440.0	492.00	543.00	1	713.00	0.90	1

PACKAGING

Part Number	Component Package	Quantity
SMBJxxxXX	DO-214AA	500

RATINGS AND CHARACTERISTIC CURVES (TA=25 unless

otherwise noted)

FIG.1- PEAK PULSE POWER RATING CURVE

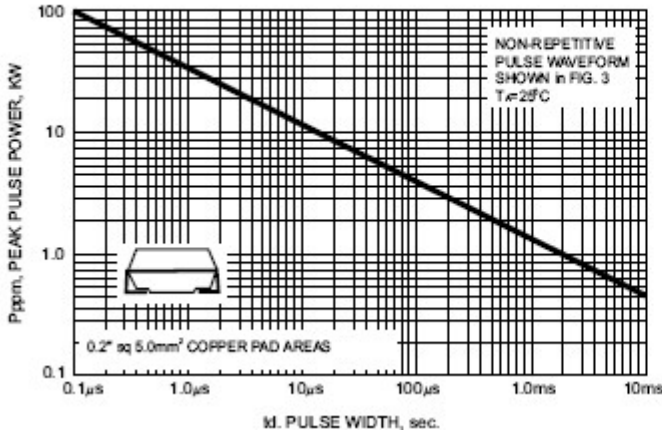

FIG.2- PULSE DERATING CURVE

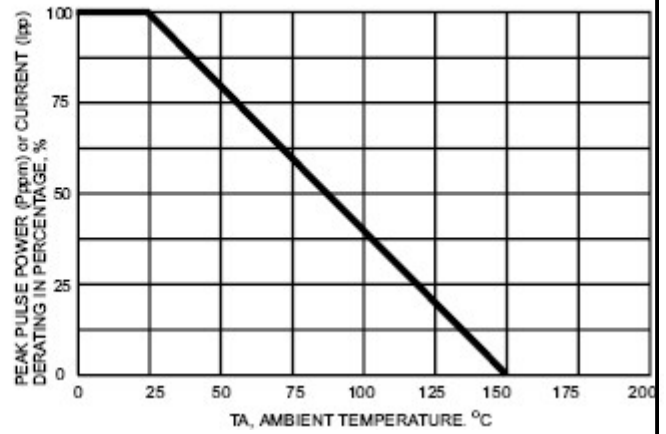

FIG.3- PULSE WAVEFORM

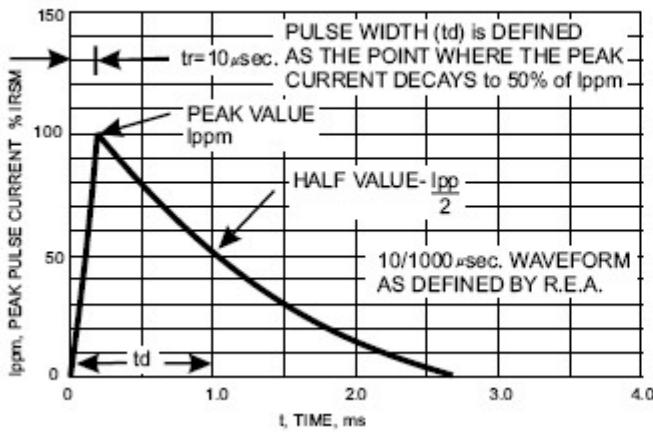

FIG.4- MAXIMUM NON-REPETITIVE FORWARD SURGE CURRENT

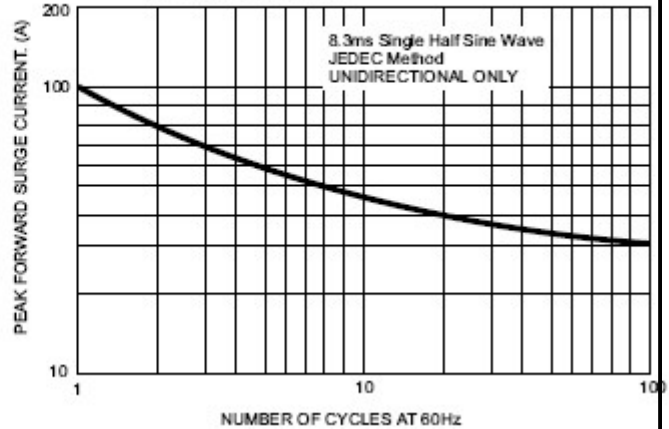
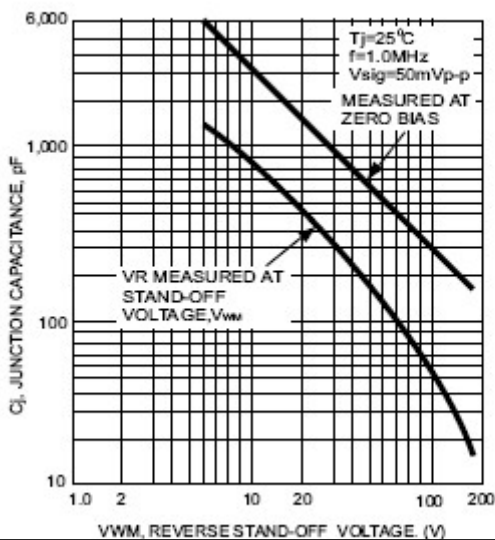

FIG.5- TYPICAL JUNCTION CAPACITANCE



X-ON Electronics

Largest Supplier of Electrical and Electronic Components

Click to view similar products for [ESD Suppressors / TVS Diodes category](#):

Click to view products by [SEMBO manufacturer](#):

Other Similar products are found below :

[60KS200C](#) [D18V0L1B2LP-7B](#) [D5V0F4U5P5-7](#) [DESD5V0U1BB-7](#) [NTE4902](#) [P4KE27CA](#) [P6KE11CA](#) [P6KE39CA-TP](#) [P6KE8.2A](#)
[SA110CA](#) [SA60CA](#) [SA64CA](#) [SMBJ12CATR](#) [SMBJ33CATR](#) [SMBJ8.0A](#) [ESD101-B1-02ELS E6327](#) [ESD105-B1-02EL E6327](#) [ESD112-B1-02EL E6327](#) [ESD119B1W01005E6327XTSA1](#) [ESD5V0L1B02VH6327XTSA1](#) [ESD7451N2T5G](#) [19180-510](#) [CPDT-5V0USP-HF](#)
[3.0SMCJ33CA-F](#) [3.0SMCJ36A-F](#) [HSPC16701B02TP](#) [D3V3Q1B2DLP3-7](#) [D55V0M1B2WS-7](#) [DESD5V0U1BL-7B](#) [DRTR5V0U4SL-7](#)
[SCM1293A-04SO](#) [ESD200-B1-CSP0201 E6327](#) [SM12-7](#) [SMF8.0A-TP](#) [SMLJ45CA-TP](#) [SMQA1000T1G](#) [CEN955 W/DATA](#) [82350120560](#)
[VESD12A1A-HD1-GS08](#) [CPDUR5V0R-HF](#) [CPDQC5V0U-HF](#) [CPDQC5V0USP-HF](#) [CPDQC5V0-HF](#) [D1213A-01LP4-7B](#) [D1213A-02WL-7](#)
[MMAD1108/TR13](#) [5KP100A](#) [5KP15A](#) [5KP18A](#) [5KP48A](#)