

SKiIP 01NEC066V3



MiniSKiIP[®] 0

1-phase bridge rectifier +
3-phase bridge inverter

SKiIP 01NEC066V3

Features

- Trench IGBTs
- Robust and soft freewheeling diodes in CAL technology
- Highly reliable spring contacts for electrical connections
- UL recognised file no. E63532

Typical Applications*

- Inverter up to 3,5 kVA
- Typical motor power 1,5 kW

Remarks

- Case temperature limited to $T_C = 125^\circ\text{C}$ max.
- Product reliability results are valid for $T_j = 150^\circ\text{C}$
- SC data: $t_p \leq 6 \mu\text{s}$; $V_{GE} \leq 15 \text{ V}$; $T_j = 150^\circ\text{C}$; $V_{CC} = 360 \text{ V}$
- V_{CEsat} , $V_F =$ chip level value

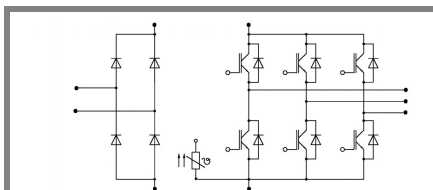

NEC

Absolute Maximum Ratings		$T_s = 25^\circ\text{C}$, unless otherwise specified	
Symbol	Conditions	Values	Units
IGBT - Inverter			
V_{CES}		600	V
I_C	$T_s = 25 (70)^\circ\text{C}$, $T_j = 150^\circ\text{C}$	12 (11)	A
I_C	$T_s = 25 (70)^\circ\text{C}$, $T_j = 175^\circ\text{C}$	12 (12)	A
I_{CRM}	$t_p = 1 \text{ ms}$	12	A
V_{GES}		± 20	V
Diode - Inverter			
I_F	$T_s = 25 (70)^\circ\text{C}$, $T_j = 150^\circ\text{C}$	12 (12)	A
I_F	$T_s = 25 (70)^\circ\text{C}$, $T_j = 175^\circ\text{C}$	12 (12)	A
I_{FRM}	$t_p = 1 \text{ ms}$	12	A
Diode - Rectifier			
V_{RRM}		800	V
I_F	$T_s = 70^\circ\text{C}$	35	A
I_{FSM}	$t_p = 10 \text{ ms}$, $\sin 180^\circ$, $T_j = 25^\circ\text{C}$	220	A
i^2t	$t_p = 10 \text{ ms}$, $\sin 180^\circ$, $T_j = 25^\circ\text{C}$	240	A^2s
I_{tRMS}	per power terminal (20 A / spring)	20	A
T_j	IGBT, Diode	-40...+175	$^\circ\text{C}$
T_{stg}		-40...+125	$^\circ\text{C}$
V_{isol}	AC, 1 min.	2500	V

Characteristics		$T_s = 25^\circ\text{C}$, unless otherwise specified			
Symbol	Conditions	min.	typ.	max.	Units
IGBT - Inverter					
$V_{CE(sat)}$	$I_{Cnom} = 6 \text{ A}$, $T_j = 25 (150)^\circ\text{C}$	1,1	1,45 (1,65)	1,85 (2,05)	V
$V_{GE(th)}$	$V_{GE} = V_{CE}$, $I_C = 1 \text{ mA}$		5,8		V
$V_{CE(TO)}$	$T_j = 25 (150)^\circ\text{C}$		0,9 (0,7)	1,1 (1)	V
r_{CE}	$T_j = 25 (150)^\circ\text{C}$		100 (167)	134 (184)	$\text{m}\Omega$
C_{ies}	$V_{CE} = 25 \text{ V}$, $V_{GE} = 0 \text{ V}$, $f = 1 \text{ MHz}$		0,45		nF
C_{oes}	$V_{CE} = 25 \text{ V}$, $V_{GE} = 0 \text{ V}$, $f = 1 \text{ MHz}$		0,1		nF
C_{res}	$V_{CE} = 25 \text{ V}$, $V_{GE} = 0 \text{ V}$, $f = 1 \text{ MHz}$		0,05		nF
$R_{CC+EE'}$	spring contact-chip $T_s = 25 (150)^\circ\text{C}$				$\text{m}\Omega$
$R_{th(j-s)}$	per IGBT		2,4		K/W
$t_{d(on)}$	under following conditions		20		ns
t_r	$V_{CC} = 300 \text{ V}$, $V_{GE} = -8\text{V}/+15\text{V}$		25		ns
$t_{d(off)}$	$I_{Cnom} = 6 \text{ A}$, $T_j = 150^\circ\text{C}$		175		ns
t_f	$R_{Gon} = R_{Goff} = 47 \Omega$		60		ns
$E_{on} (E_{off})$	inductive load		0,3 (0,2)		mJ
Diode - Inverter					
$V_F = V_{EC}$	$I_F = 6 \text{ A}$, $T_j = 25 (150)^\circ\text{C}$		1,3 (1,3)	1,6 (1,6)	V
$V_{(TO)}$	$T_j = 25 (150)^\circ\text{C}$		0,9 (0,8)	1 (0,9)	V
r_T	$T_j = 25 (150)^\circ\text{C}$		67 (83)	100 (117)	$\text{m}\Omega$
$R_{th(j-s)}$	per diode		3		K/W
I_{RRM}	under following conditions		11,2		A
Q_{rr}	$I_{Fnom} = 6 \text{ A}$, $V_R = 300 \text{ V}$		0,9		μC
E_{rr}	$V_{GE} = 0 \text{ V}$, $T_j = 150^\circ\text{C}$ $di_F/dt = 520 \text{ A}/\mu\text{s}$		0,2		mJ
Diode - Rectifier					
V_F	$I_{Fnom} = 15 \text{ A}$, $T_j = 25^\circ\text{C}$		1,1		V
$V_{(TO)}$	$T_j = 150^\circ\text{C}$		0,8		V
r_T	$T_j = 150^\circ\text{C}$		20		$\text{m}\Omega$
$R_{th(j-s)}$	per diode		1,5		K/W
Temperature Sensor					
R_{ts}	3 %, $T_r = 25 (100)^\circ\text{C}$		1000(1670)		Ω
Mechanical Data					
w			21,5		g
M_s	Mounting torque	2		2,5	Nm

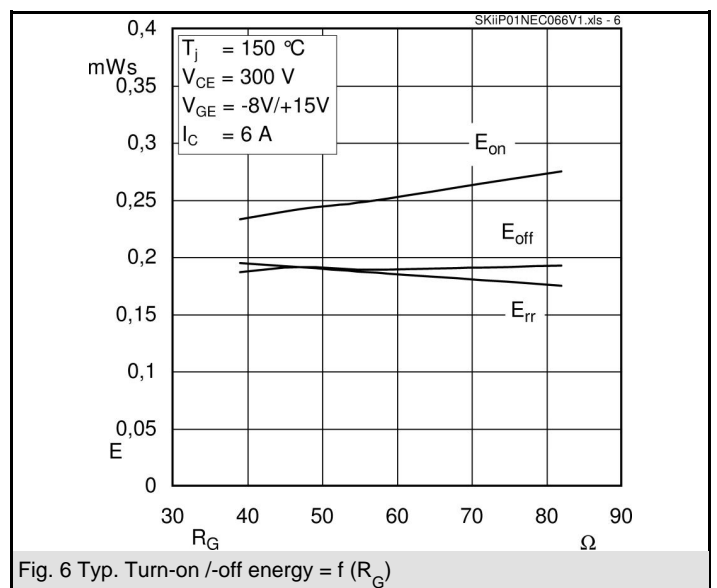
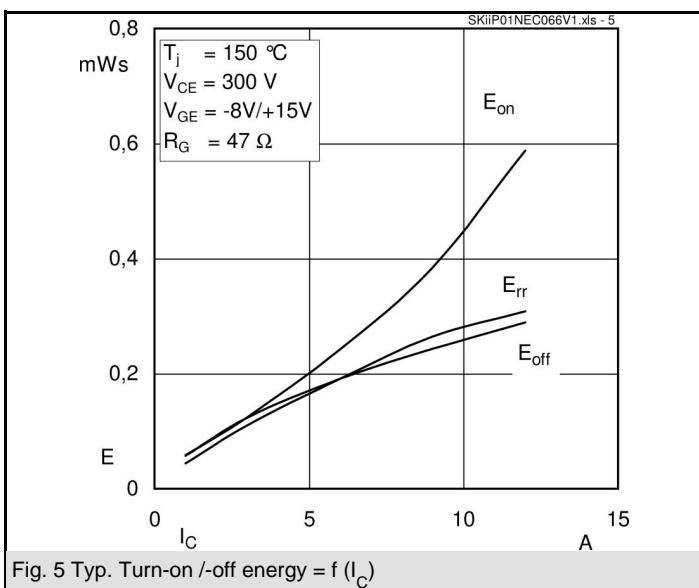
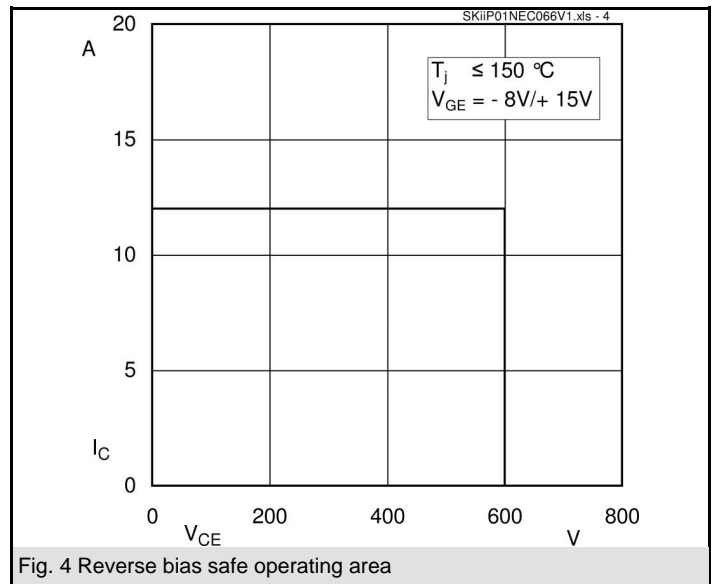
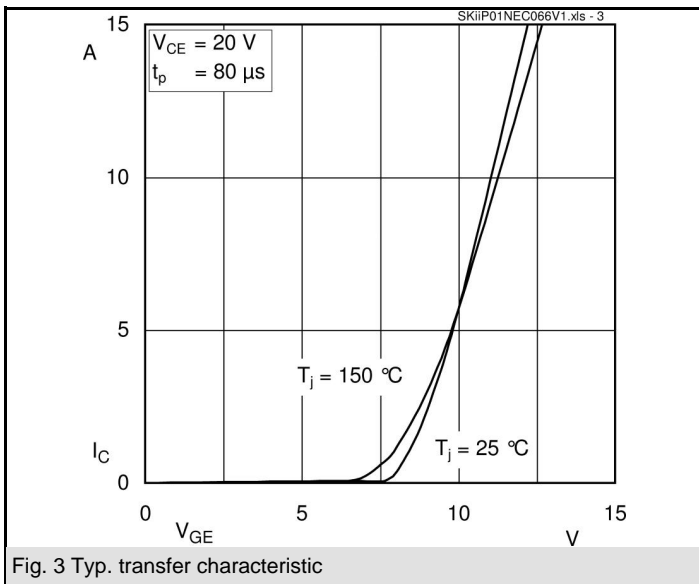
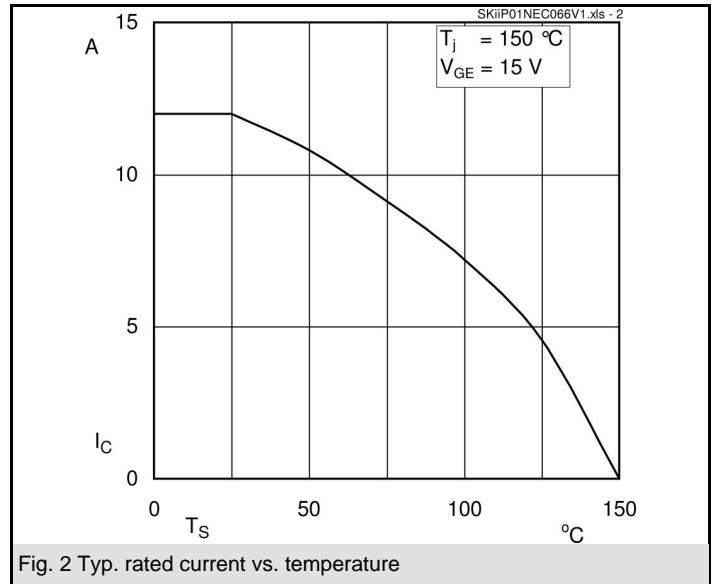
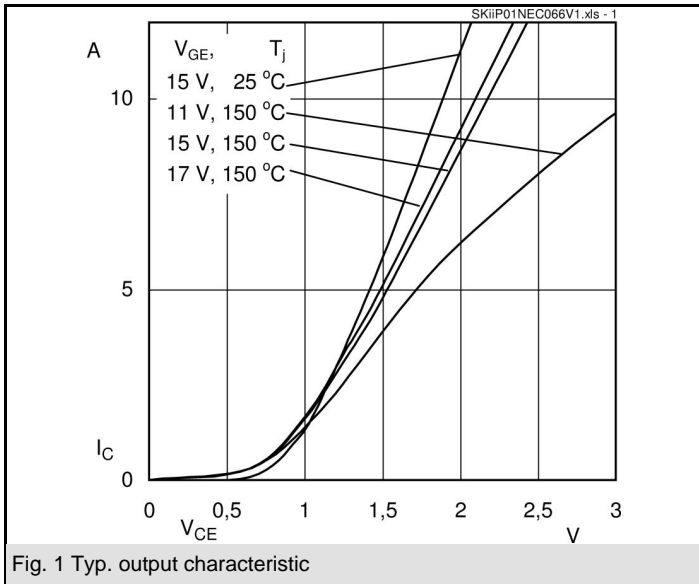

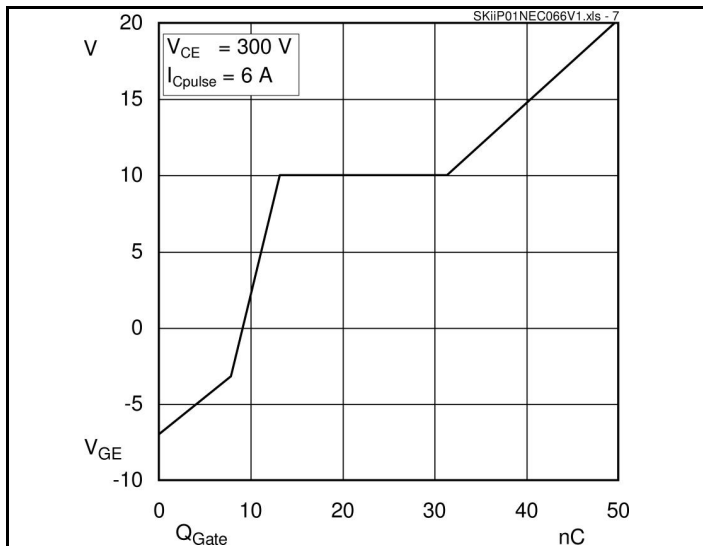

Fig. 7 Typ. gate charge characteristic

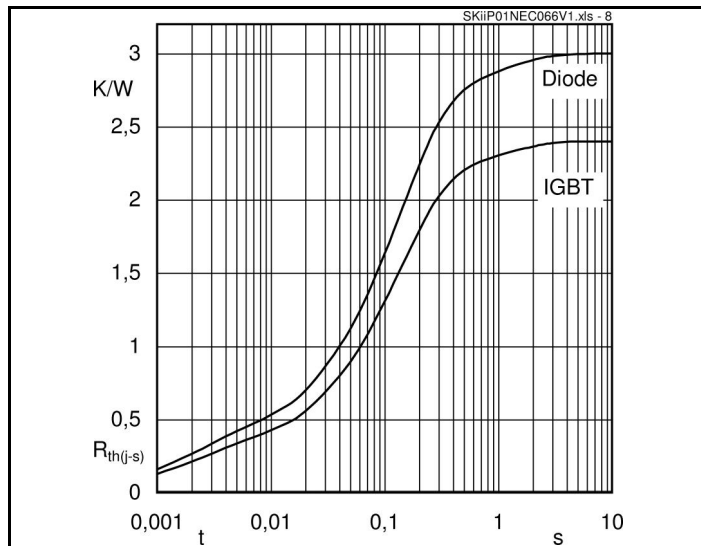

Fig. 8 Typ. thermal impedance

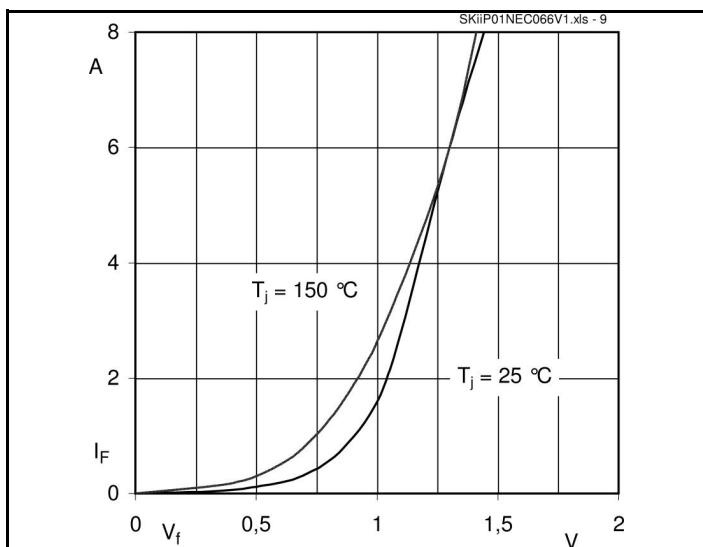

Fig. 9 Typ. freewheeling diode forward characteristic

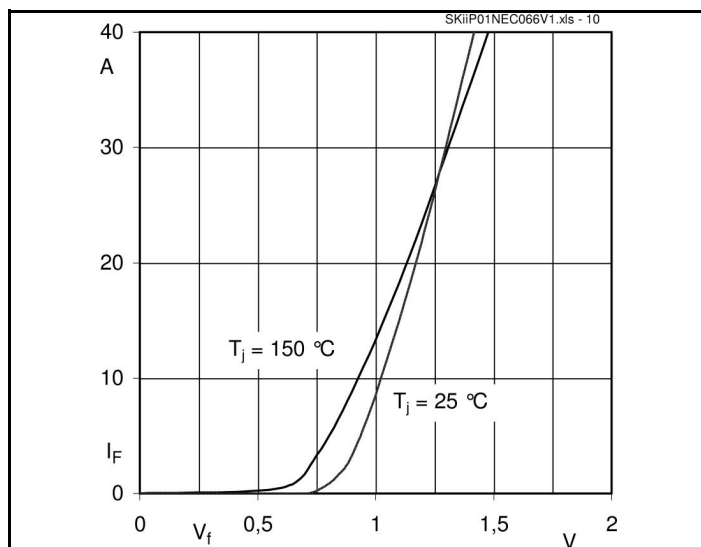
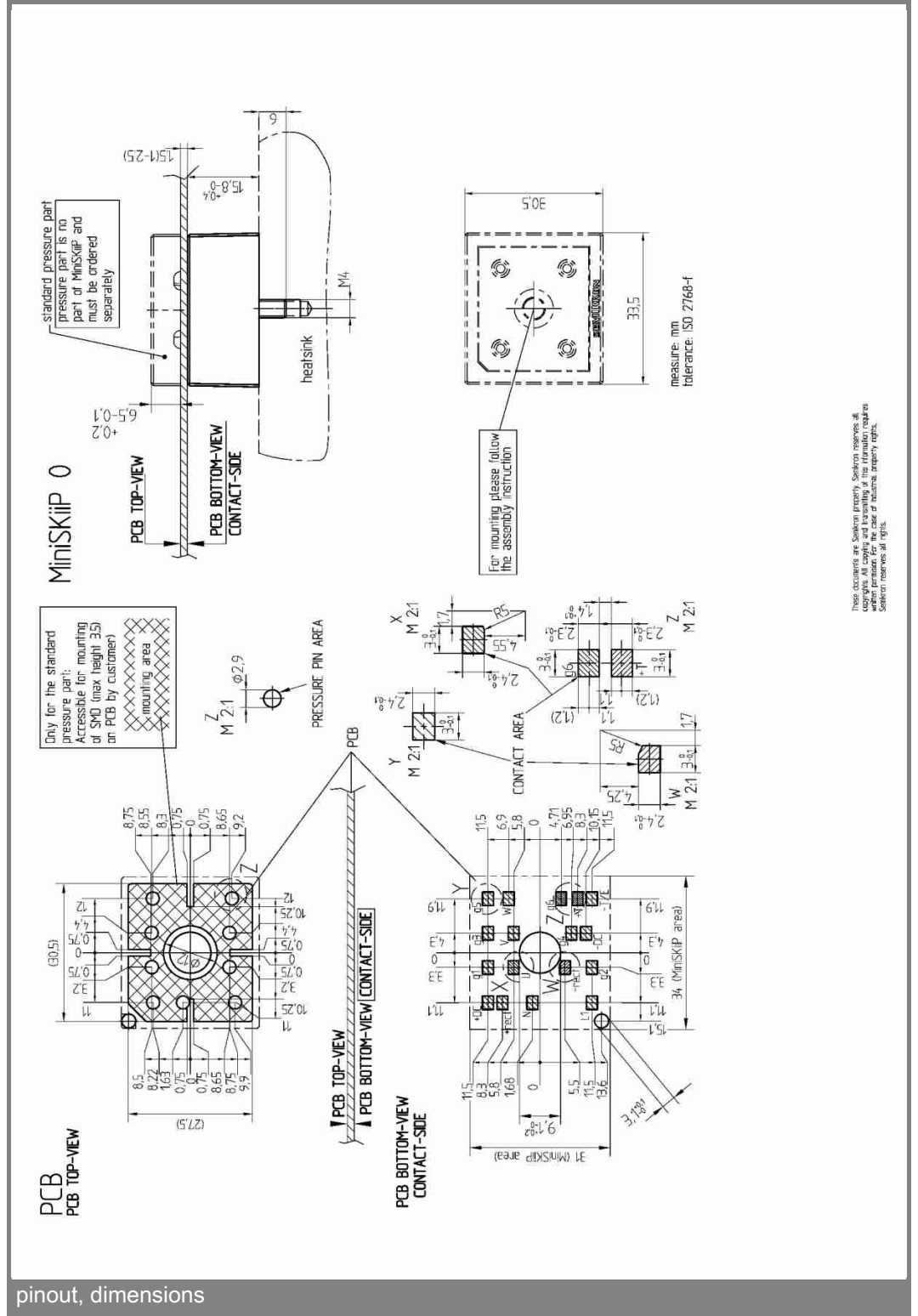
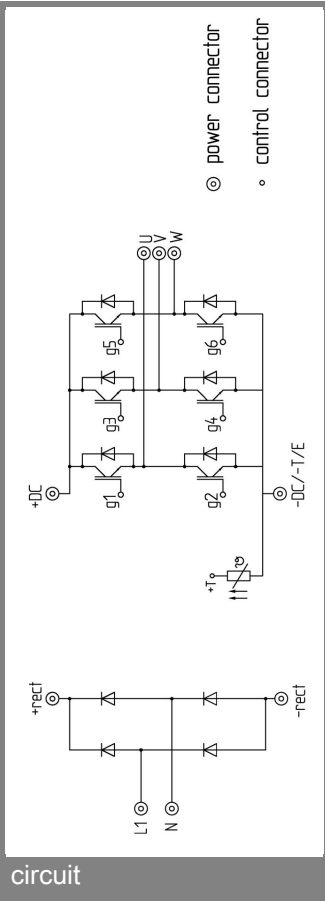

Fig. 10 Typ. input bridge forward characteristic



These documents are customer property. Confide, reserve all copyrights. All copies and translations of this information require written permission for the case of industrial property rights. SEMIKRON reserves all rights.

This is an electrostatic discharge sensitive device (ESDS), international standard IEC 60747-1, Chapter IX.

* The specifications of our components may not be considered as an assurance of component characteristics. Components have to be tested for the respective application. Adjustments may be necessary. The use of SEMIKRON products in life support appliances and systems is subject to prior specification and written approval by SEMIKRON. We therefore strongly recommend prior consultation of our personal.

X-ON Electronics

Largest Supplier of Electrical and Electronic Components

Click to view similar products for [semikron](#) manufacturer:

Other Similar products are found below :

[SKD 60/12](#) [SKKT 42B12 E](#) [SKM200GB12T4](#) [SKR 130/14](#) [SKCH 40/16](#) [SKKT 92/18E](#) [SKYPER 32 R](#) [SKKH 27/16E](#) [SKKD 380/16](#) [SKD 110/08](#) [SKD 62/12](#) [SKIIP 36NAB126V1 M20](#) [SKKD 162/20H4](#) [SKKD 380/08](#) [SKKH 72/20E H4](#) [SKKT 250/12E](#) [SKN71/02](#) [SKN 100/12](#) [SKN 100/14](#) [SKR 100/08](#) [SKIIP 24AC12T4V1 M20](#) [SKIIP 28AHB16V1 M20](#) [SKIIP 35NAB126V10 M20](#) [SKKH 570/16E](#) [SKKE 380/16](#) [SKR 130/18](#) [SKKD 26/14](#) [SKKT 570/18E](#) [SKN 130/14](#) [SKPC200-240](#) [SKPC100Z-440](#) [SK 100 WT 12](#) [SK 25 UT 12](#) [SKR70/04](#) [SKD35/16](#) [SKKT 42/08E](#) [SKCH 40/08](#) [SKD 62/18](#) [SKD 82/08](#) [SKIIP 23NAB126V1 M20](#) [SKKQ 1200/14E](#) [SKR 60F12](#) [SKR 100/04](#) [SKR 100/14](#) [SKIIP 37AC12T4V1 M20](#) [SKD 60/16](#) [SKD 62/08](#) [SKDT 60/12](#) [SKKT 106B16 E](#) [SKKD 60F17](#)