

SKiiP 11NAB12T4V1

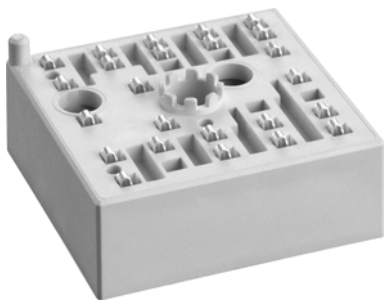

MiniSKiiP® 1

SKiiP 11NAB12T4V1

Features

- Trench 4 IGBTs
- Robust and soft freewheeling diodes in CAL technology
- Highly reliable spring contacts for electrical connections
- UL recognised: File no. E63532

Typical Applications*

- Inverter up to 8 kVA
- Typical motor power 4 kW

Remarks

- Max. case temperature limited to $T_C=125^\circ\text{C}$
- Product reliability results valid for $T_j \leq 150^\circ\text{C}$ (recommended $T_{j,op} = -40 \dots +150^\circ\text{C}$)
- Please refer to MiniSKiiP "Technical Explanations" and "Mounting Instructions" for further information

Absolute Maximum Ratings

Symbol	Conditions	Values	Unit
Inverter - IGBT			
V_{CES}	$T_j = 25^\circ\text{C}$	1200	V
I_C	$\lambda_{paste}=0.8 \text{ W/(mK)}$	$T_s = 25^\circ\text{C}$	18
	$T_j = 175^\circ\text{C}$	$T_s = 70^\circ\text{C}$	15
I_C	$\lambda_{paste}=2.5 \text{ W/(mK)}$	$T_s = 25^\circ\text{C}$	19
	$T_j = 175^\circ\text{C}$	$T_s = 70^\circ\text{C}$	16
I_{Cnom}		8	A
I_{CRM}	$I_{CRM} = 3 \times I_{Cnom}$	24	A
V_{GES}		-20 ... 20	V
t_{psc}	$V_{CC} = 800 \text{ V}$	$T_j = 150^\circ\text{C}$	10
	$V_{GE} \leq 15 \text{ V}$		
	$V_{CES} \leq 1200 \text{ V}$		
T_j		-40 ... 175	$^\circ\text{C}$
Chopper - IGBT			
V_{CES}	$T_j = 25^\circ\text{C}$	1200	V
I_C	$\lambda_{paste}=0.8 \text{ W/(mK)}$	$T_s = 25^\circ\text{C}$	18
	$T_j = 175^\circ\text{C}$	$T_s = 70^\circ\text{C}$	15
I_C	$\lambda_{paste}=2.5 \text{ W/(mK)}$	$T_s = 25^\circ\text{C}$	19
	$T_j = 175^\circ\text{C}$	$T_s = 70^\circ\text{C}$	16
I_{Cnom}		8	A
I_{CRM}	$I_{CRM} = 3 \times I_{Cnom}$	24	A
V_{GES}		-20 ... 20	V
t_{psc}	$V_{CC} = 800 \text{ V}$	$T_j = 150^\circ\text{C}$	10
	$V_{GE} \leq 15 \text{ V}$		
	$V_{CES} \leq 1200 \text{ V}$		
T_j		-40 ... 175	$^\circ\text{C}$
Inverse - Diode			
V_{RRM}	$T_j = 25^\circ\text{C}$	1200	V
I_F	$\lambda_{paste}=0.8 \text{ W/(mK)}$	$T_s = 25^\circ\text{C}$	15
	$T_j = 175^\circ\text{C}$	$T_s = 70^\circ\text{C}$	12
I_F	$\lambda_{paste}=2.5 \text{ W/(mK)}$	$T_s = 25^\circ\text{C}$	17
	$T_j = 175^\circ\text{C}$	$T_s = 70^\circ\text{C}$	13
I_{Fnom}		8	A
I_{FRM}	$I_{FRM} = 3 \times I_{Fnom}$	24	A
I_{FSM}	$t_p = 10 \text{ ms, sin } 180^\circ, T_j = 150^\circ\text{C}$	36	A
T_j		-40 ... 175	$^\circ\text{C}$
Freewheeling - Diode			
V_{RRM}	$T_j = 25^\circ\text{C}$	1200	V
I_F	$\lambda_{paste}=0.8 \text{ W/(mK)}$	$T_s = 25^\circ\text{C}$	15
	$T_j = 175^\circ\text{C}$	$T_s = 70^\circ\text{C}$	12
I_F	$\lambda_{paste}=2.5 \text{ W/(mK)}$	$T_s = 25^\circ\text{C}$	17
	$T_j = 175^\circ\text{C}$	$T_s = 70^\circ\text{C}$	13
I_{Fnom}		8	A
I_{FRM}	$I_{FRM} = 3 \times I_{Fnom}$	24	A
I_{FSM}	$t_p = 10 \text{ ms, sin } 180^\circ, T_j = 150^\circ\text{C}$	36	A
T_j		-40 ... 175	$^\circ\text{C}$

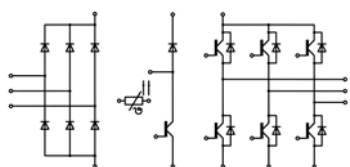

NAB

SKiiP 11NAB12T4V1

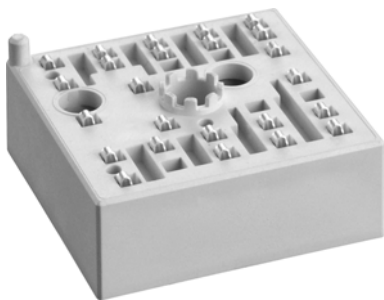

MiniSKiiP® 1

SKiiP 11NAB12T4V1

Features

- Trench 4 IGBTs
- Robust and soft freewheeling diodes in CAL technology
- Highly reliable spring contacts for electrical connections
- UL recognised: File no. E63532

Typical Applications*

- Inverter up to 8 kVA
- Typical motor power 4 kW

Remarks

- Max. case temperature limited to $T_C=125^\circ\text{C}$
- Product reliability results valid for $T_j \leq 150^\circ\text{C}$ (recommended $T_{j,op} = -40 \dots +150^\circ\text{C}$)
- Please refer to MiniSKiiP "Technical Explanations" and "Mounting Instructions" for further information

Absolute Maximum Ratings

Symbol	Conditions	Values	Unit	
Rectifier - Diode				
V_{RRM}	$T_j = 25^\circ\text{C}$	1600	V	
I_F	$\lambda_{paste}=0.8 \text{ W/(mK)}$	$T_s = 25^\circ\text{C}$	39	A
	$T_j = 150^\circ\text{C}$	$T_s = 70^\circ\text{C}$	29	A
I_F	$\lambda_{paste}=2.5 \text{ W/(mK)}$	$T_s = 25^\circ\text{C}$	42	A
	$T_j = 150^\circ\text{C}$	$T_s = 70^\circ\text{C}$	32	A
I_{Fnom}		8	A	
I_{FSM}	10 ms	$T_j = 25^\circ\text{C}$	220	A
	sin 180°	$T_j = 150^\circ\text{C}$	200	A
I^2t	10 ms	$T_j = 25^\circ\text{C}$	242	A ² s
	sin 180°	$T_j = 150^\circ\text{C}$	200	A ² s
T_j		-40 ... 150	°C	
Module				
$I_{t(RMS)}$	$T_{terminal} = 80^\circ\text{C}$,	12	A	
T_{stg}		-40 ... 125	°C	
V_{isol}	AC sinus 50 Hz, 1 min	2500	V	

Characteristics

Symbol	Conditions	min.	typ.	max.	Unit
Inverter - IGBT					
$V_{CE(sat)}$	$I_C = 8 \text{ A}$ $V_{GE} = 15 \text{ V}$ chiplevel	$T_j = 25^\circ\text{C}$	1.85	2.10	V
		$T_j = 150^\circ\text{C}$	2.25	2.45	V
V_{CE0}	chiplevel	$T_j = 25^\circ\text{C}$	0.80	0.90	V
		$T_j = 150^\circ\text{C}$	0.70	0.80	V
r_{CE}	$V_{GE} = 15 \text{ V}$ chiplevel	$T_j = 25^\circ\text{C}$	131	150	mΩ
		$T_j = 150^\circ\text{C}$	194	206	mΩ
$V_{GE(th)}$	$V_{GE} = V_{CE} \text{ V}, I_C = 1 \text{ mA}$	5	5.8	6.5	V
I_{CES}	$V_{GE} = 0 \text{ V}, V_{CE} = 1200 \text{ V}, T_j = 25^\circ\text{C}$		0.1	0.3	mA
C_{ies}	$V_{CE} = 25 \text{ V}$ $V_{GE} = 0 \text{ V}$	$f = 1 \text{ MHz}$	0.49		nF
C_{oes}		$f = 1 \text{ MHz}$	0.05		nF
C_{res}		$f = 1 \text{ MHz}$	0.03		nF
Q_G	$V_{GE} = -8 \text{ V} \dots +15 \text{ V}$		45		nC
R_{Gint}	$T_j = 25^\circ\text{C}$		0		Ω
$t_{d(on)}$	$V_{CC} = 600 \text{ V}$ $I_C = 8 \text{ A}$	$T_j = 150^\circ\text{C}$	31		ns
t_r		$T_j = 150^\circ\text{C}$	31		ns
E_{on}	$R_{Gon} = 47 \Omega$ $R_{Goff} = 47 \Omega$	$T_j = 150^\circ\text{C}$	0.87		mJ
$t_{d(off)}$		$T_j = 150^\circ\text{C}$	290		ns
t_f		$T_j = 150^\circ\text{C}$	70		ns
E_{off}	$V_{GE} = +15/-15 \text{ V}$	$T_j = 150^\circ\text{C}$	0.74		mJ
$R_{th(j-s)}$	per IGBT, $\lambda_{paste}=0.8 \text{ W/(mK)}$		1.84		K/W
$R_{th(j-s)}$	per IGBT, $\lambda_{paste}=2.5 \text{ W/(mK)}$		1.58		K/W

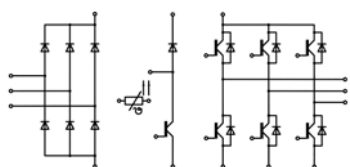

NAB

SKiiP 11NAB12T4V1



MiniSKiiP® 1

SKiiP 11NAB12T4V1

Features

- Trench 4 IGBTs
- Robust and soft freewheeling diodes in CAL technology
- Highly reliable spring contacts for electrical connections
- UL recognised: File no. E63532

Typical Applications*

- Inverter up to 8 kVA
- Typical motor power 4 kW

Remarks

- Max. case temperature limited to $T_C=125^\circ\text{C}$
- Product reliability results valid for $T_j \leq 150^\circ\text{C}$ (recommended $T_{j,op} = -40 \dots +150^\circ\text{C}$)
- Please refer to MiniSKiiP "Technical Explanations" and "Mounting Instructions" for further information

Characteristics						
Symbol	Conditions		min.	typ.	max.	Unit
Chopper - IGBT						
$V_{CE(sat)}$	$I_C = 8 \text{ A}$ $V_{GE} = 15 \text{ V}$ chipelevel	$T_j = 25^\circ\text{C}$		1.85	2.10	V
		$T_j = 150^\circ\text{C}$		2.25	2.45	V
V_{CE0}	chipelevel	$T_j = 25^\circ\text{C}$		0.80	0.90	V
		$T_j = 150^\circ\text{C}$		0.70	0.80	V
r_{CE}	$V_{GE} = 15 \text{ V}$ chipelevel	$T_j = 25^\circ\text{C}$		131	150	m Ω
		$T_j = 150^\circ\text{C}$		194	206	m Ω
$V_{GE(th)}$	$V_{GE} = V_{CE} \text{ V}, I_C = 1 \text{ mA}$		5	5.8	6.5	V
I_{CES}	$V_{GE} = 0 \text{ V}, V_{CE} = 1200 \text{ V}, T_j = 25^\circ\text{C}$			0.1	0.3	mA
Q_G	$V_{GE} = -8 \text{ V} \dots +15 \text{ V}$			45		nC
R_{Gint}	$T_j = 25^\circ\text{C}$			0		Ω
$t_{d(on)}$	$V_{CC} = 600 \text{ V}$ $I_C = 8 \text{ A}$	$T_j = 150^\circ\text{C}$		31		ns
t_r	$R_{G on} = 47 \Omega$ $R_{G off} = 47 \Omega$	$T_j = 150^\circ\text{C}$		31		ns
E_{on}		$T_j = 150^\circ\text{C}$		0.87		mJ
$t_{d(off)}$		$T_j = 150^\circ\text{C}$		290		ns
t_f		$T_j = 150^\circ\text{C}$		70		ns
E_{off}	$V_{GE} = +15/-15 \text{ V}$	$T_j = 150^\circ\text{C}$		0.74		mJ
$R_{th(j-s)}$	per IGBT, $\lambda_{paste}=0.8 \text{ W}/(\text{mK})$			1.84		K/W
$R_{th(j-s)}$	per IGBT, $\lambda_{paste}=2.5 \text{ W}/(\text{mK})$			1.58		K/W
Inverse - Diode						
$V_F = V_{EC}$	$I_F = 8 \text{ A}$ $V_{GE} = 0 \text{ V}$ chipelevel	$T_j = 25^\circ\text{C}$		2.33	2.65	V
		$T_j = 150^\circ\text{C}$		2.35	2.68	V
V_{F0}	chipelevel	$T_j = 25^\circ\text{C}$		1.30	1.50	V
		$T_j = 150^\circ\text{C}$		0.90	1.10	V
r_F	chipelevel	$T_j = 25^\circ\text{C}$		129	144	m Ω
		$T_j = 150^\circ\text{C}$		181	198	m Ω
I_{RRM}	$I_F = 8 \text{ A}$	$T_j = 150^\circ\text{C}$		8.3		A
Q_{rr}	$di/dt_{off} = 380 \text{ A}/\mu\text{s}$ $V_{GE} = -15 \text{ V}$	$T_j = 150^\circ\text{C}$		1.35		μC
E_{rr}	$V_{CC} = 600 \text{ V}$	$T_j = 150^\circ\text{C}$		0.57		mJ
$R_{th(j-s)}$	per Diode, $\lambda_{paste}=0.8 \text{ W}/(\text{mK})$			2.53		K/W
$R_{th(j-s)}$	per Diode, $\lambda_{paste}=2.5 \text{ W}/(\text{mK})$			2.2		K/W
Freewheeling - Diode						
$V_F = V_{EC}$	$I_F = 8 \text{ A}$ $V_{GE} = 0 \text{ V}$ chipelevel	$T_j = 25^\circ\text{C}$		2.33	2.65	V
		$T_j = 150^\circ\text{C}$		2.35	2.68	V
V_{F0}	chipelevel	$T_j = 25^\circ\text{C}$		1.30	1.50	V
		$T_j = 150^\circ\text{C}$		0.90	1.10	V
r_F	chipelevel	$T_j = 25^\circ\text{C}$		129	144	m Ω
		$T_j = 150^\circ\text{C}$		181	198	m Ω
I_{RRM}	$I_F = 8 \text{ A}$	$T_j = 150^\circ\text{C}$		8.3		A
Q_{rr}	$di/dt_{off} = 380 \text{ A}/\mu\text{s}$ $V_{GE} = -15 \text{ V}$	$T_j = 150^\circ\text{C}$		1.35		μC
E_{rr}	$V_{CC} = 600 \text{ V}$	$T_j = 150^\circ\text{C}$		0.57		mJ
$R_{th(j-s)}$	per Diode, $\lambda_{paste}=0.8 \text{ W}/(\text{mK})$			2.53		K/W
$R_{th(j-s)}$	per Diode, $\lambda_{paste}=2.5 \text{ W}/(\text{mK})$			2.2		K/W

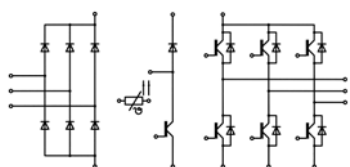

NAB

SKiiP 11NAB12T4V1



MiniSKiiP® 1

SKiiP 11NAB12T4V1

Features

- Trench 4 IGBTs
- Robust and soft freewheeling diodes in CAL technology
- Highly reliable spring contacts for electrical connections
- UL recognised: File no. E63532

Typical Applications*

- Inverter up to 8 kVA
- Typical motor power 4 kW

Remarks

- Max. case temperature limited to $T_C=125^\circ\text{C}$
- Product reliability results valid for $T_j \leq 150^\circ\text{C}$ (recommended $T_{j,op} = -40 \dots +150^\circ\text{C}$)
- Please refer to MiniSKiiP "Technical Explanations" and "Mounting Instructions" for further information

Characteristics						
Symbol	Conditions		min.	typ.	max.	Unit
Rectifier - Diode						
$V_F = V_{EC}$	$I_F = 8 \text{ A}$ $V_{GE} = 0 \text{ V}$ chipelevel	$T_j = 25^\circ\text{C}$		1.00	1.21	V
		$T_j = 125^\circ\text{C}$		0.90	1.10	V
V_{F0}	chipelevel	$T_j = 25^\circ\text{C}$		0.88	0.98	V
		$T_j = 125^\circ\text{C}$		0.73	0.83	V
r_F	chipelevel	$T_j = 25^\circ\text{C}$		15	29	m Ω
		$T_j = 125^\circ\text{C}$		21	34	m Ω
$R_{th(j-s)}$	per Diode, $\lambda_{paste}=0.8 \text{ W/(mK)}$			1.5		K/W
$R_{th(j-s)}$	per Diode, $\lambda_{paste}=2.5 \text{ W/(mK)}$			1.29		K/W
Module						
M_s	to heat sink		2		2.5	Nm
w				30		g
L_{CE}				-		nH
Temperature Sensor						
R_{100}	$T_r = 100^\circ\text{C}$			1670 \pm 3%		Ω
$R(T)$	$R(T)=1000\Omega[1+A(T-25^\circ\text{C})+B(T-25^\circ\text{C})^2]$], $A = 7.635 \cdot 10^{-3} \text{ }^\circ\text{C}^{-1}$, $B = 1.731 \cdot 10^{-5} \text{ }^\circ\text{C}^{-2}$					

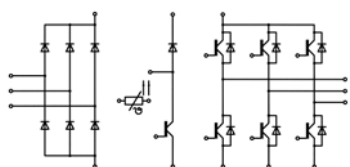

NAB

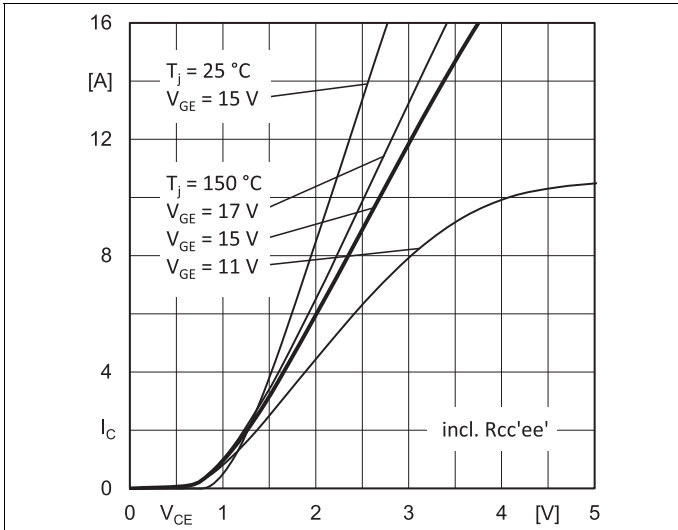

Fig. 1: Typ. output characteristic

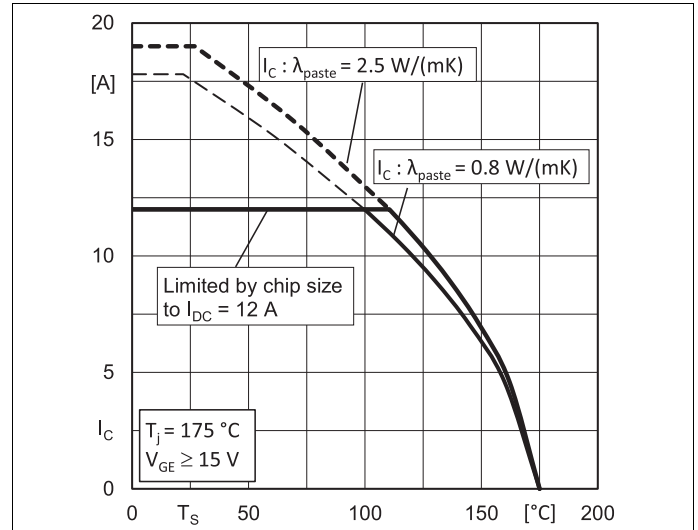

Fig. 2: Typ. rated current vs. temperature $I_C = f(T_s)$

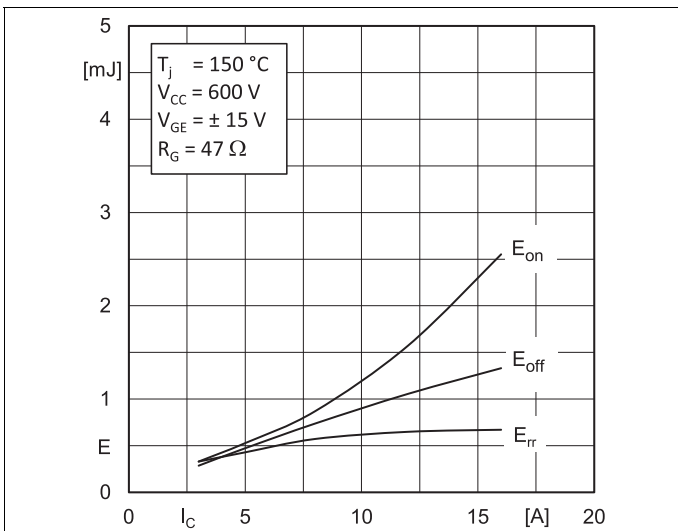

Fig. 3: Typ. turn-on /-off energy = $f(I_C)$

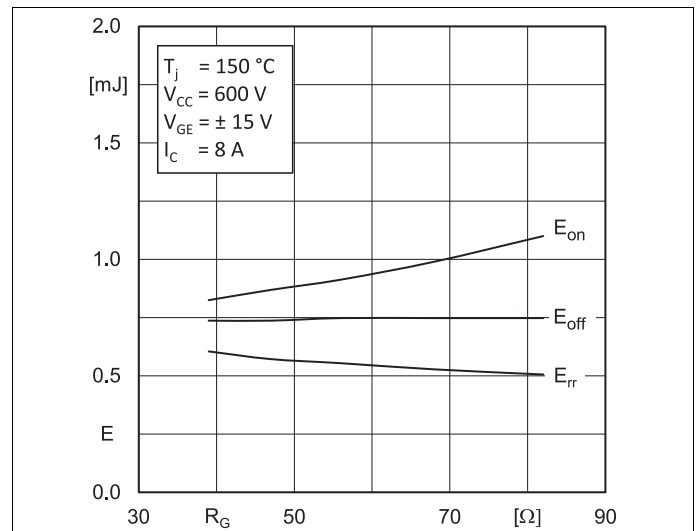

Fig. 4: Typ. turn-on /-off energy = $f(R_G)$

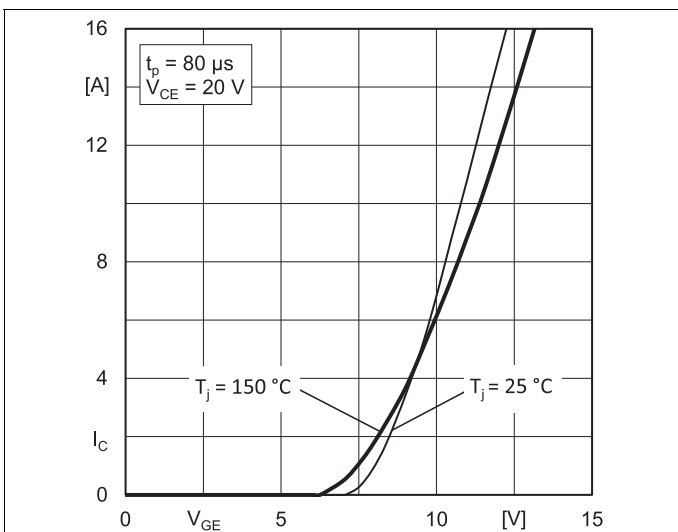

Fig. 5: Typ. transfer characteristic

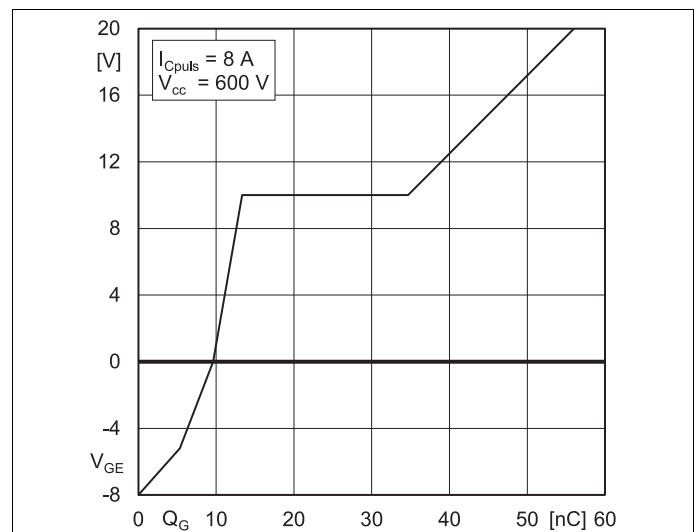

Fig. 6: Typ. gate charge characteristic

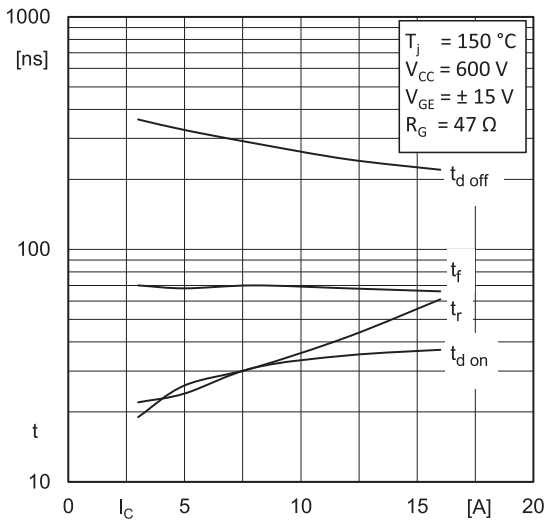

Fig. 7: Typ. switching times vs. I_C

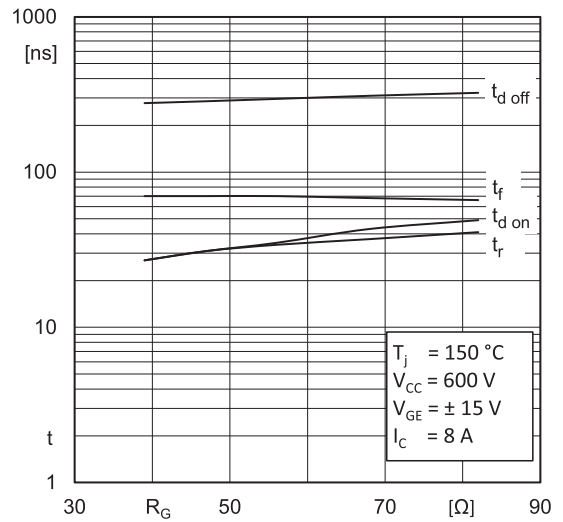

Fig. 8: Typ. switching times vs. gate resistor R_G

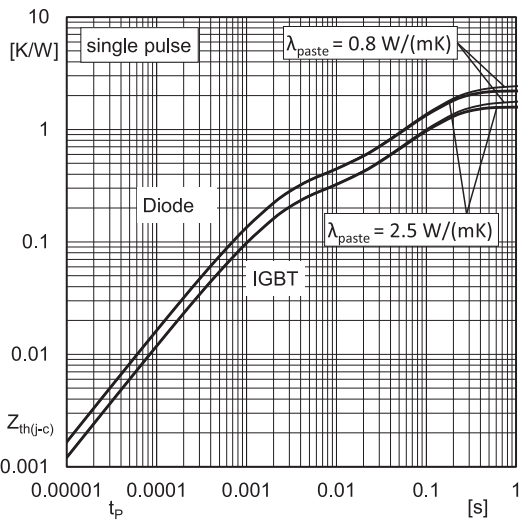

Fig. 9: Transient thermal impedance of IGBT and Diode

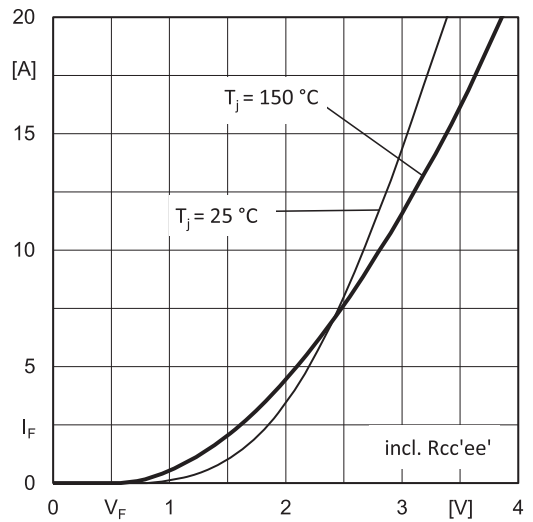

Fig. 10: CAL diode forward characteristic

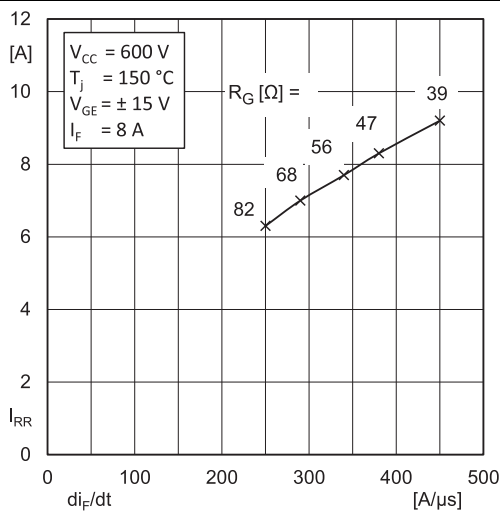

Fig. 11: Typ. CAL diode peak reverse recovery current

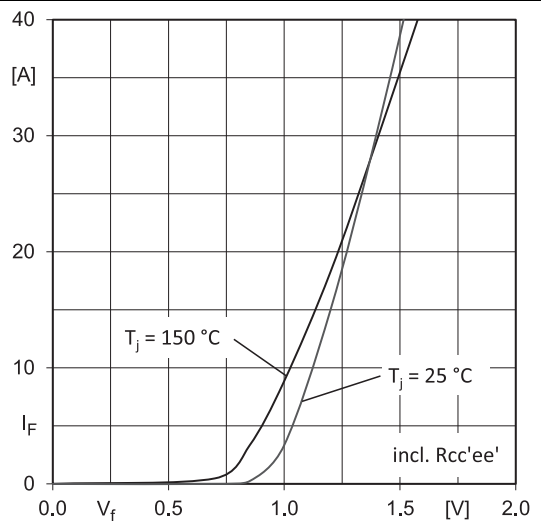
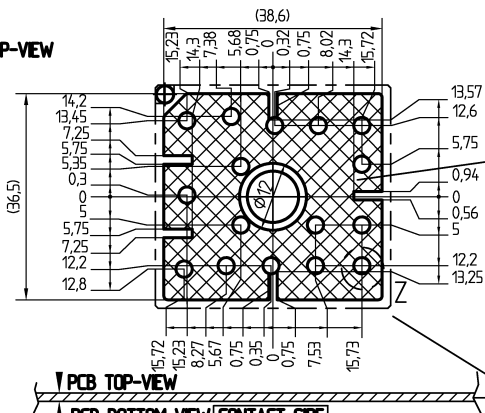

Fig. 12: Typ. input bridge forward characteristic

PCB PCB TOP-VIEW



Only for the standard pressure part:
Accessible for mounting of SMD (max height 3.5) on PCB by customer

mounting area

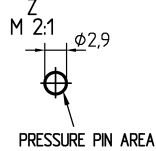

PCB TOP-VIEW
PCB BOTTOM-VIEW CONTACT-SIDE

PCB BOTTOM-VIEW CONTACT-SIDE

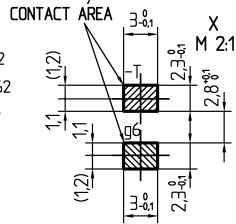
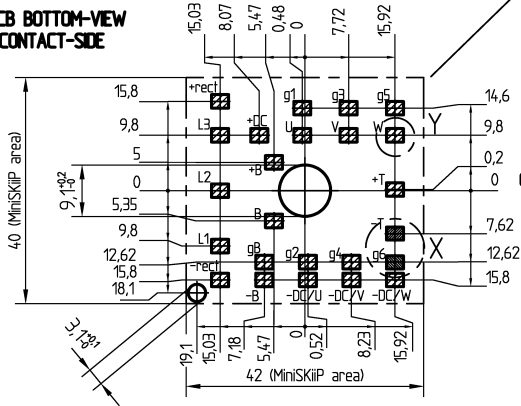

MiniSKiIP 1

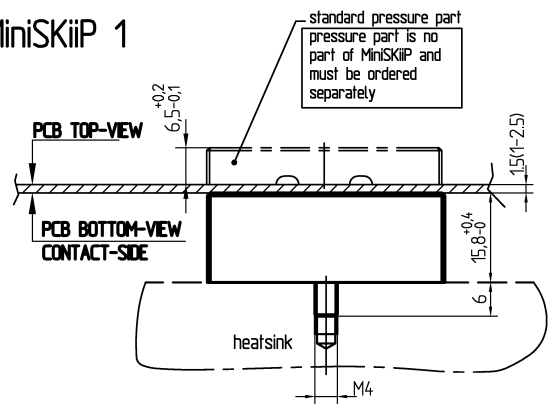

For mounting please follow the assembly instruction

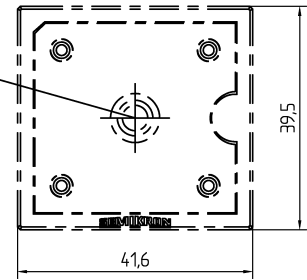

pinout, dimensions

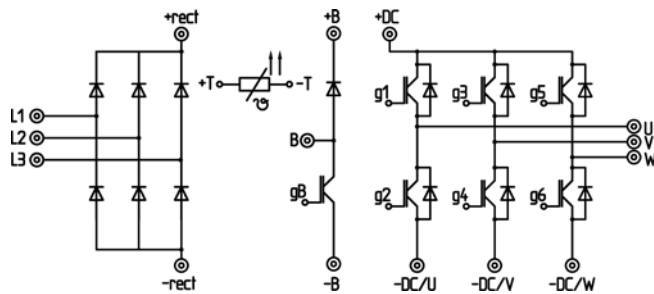

⊙ power connector
• control connector

pinout

This is an electrostatic discharge sensitive device (ESDS), international standard IEC 60747-1, chapter IX.

***IMPORTANT INFORMATION AND WARNINGS**

The specifications of SEMIKRON products may not be considered as guarantee or assurance of product characteristics ("Beschaffenheitsgarantie"). The specifications of SEMIKRON products describe only the usual characteristics of products to be expected in typical applications, which may still vary depending on the specific application. Therefore, products must be tested for the respective application in advance. Application adjustments may be necessary. The user of SEMIKRON products is responsible for the safety of their applications embedding SEMIKRON products and must take adequate safety measures to prevent the applications from causing a physical injury, fire or other problem if any of SEMIKRON products become faulty. The user is responsible to make sure that the application design is compliant with all applicable laws, regulations, norms and standards. Except as otherwise explicitly approved by SEMIKRON in a written document signed by authorized representatives of SEMIKRON, SEMIKRON products may not be used in any applications where a failure of the product or any consequences of the use thereof can reasonably be expected to result in personal injury. No representation or warranty is given and no liability is assumed with respect to the accuracy, completeness and/or use of any information herein, including without limitation, warranties of non-infringement of intellectual property rights of any third party. SEMIKRON does not assume any liability arising out of the applications or use of any product; neither does it convey any license under its patent rights, copyrights, trade secrets or other intellectual property rights, nor the rights of others. SEMIKRON makes no representation or warranty of non-infringement or alleged non-infringement of intellectual property rights of any third party which may arise from applications. Due to technical requirements our products may contain dangerous substances. For information on the types in question please contact the nearest SEMIKRON sales office. This document supersedes and replaces all information previously supplied and may be superseded by updates. SEMIKRON reserves the right to make changes.

X-ON Electronics

Largest Supplier of Electrical and Electronic Components

Click to view similar products for [IGBT Modules category](#):

Click to view products by [Semikron manufacturer](#):

Other Similar products are found below :

[F3L100R07W2E3_B11](#) [F3L15R12W2H3_B27](#) [F3L400R07ME4_B22](#) [F3L400R12PT4_B26](#) [F4-100R12KS4](#) [F4-50R07W2H3_B51](#) [F4-75R12KS4_B11](#) [FB15R06W1E3](#) [FB20R06W1E3_B11](#) [FD1000R33HE3-K](#) [FD300R06KE3](#) [FD300R12KE3](#) [FD300R12KS4_B5](#) [FD400R12KE3](#) [FD400R33KF2C-K](#) [FD401R17KF6C_B2](#) [FD-DF80R12W1H3_B52](#) [FF100R12KS4](#) [FF1200R17KE3_B2](#) [FF150R12KE3G](#) [FF200R06KE3](#) [FF200R06YE3](#) [FF200R12KT3](#) [FF200R12KT3_E](#) [FF200R12KT4](#) [FF200R17KE3](#) [FF300R06KE3_B2](#) [FF300R12KE4_E](#) [FF300R12KS4HOSA1](#) [FF300R12ME4_B11](#) [FF300R12MS4](#) [FF300R17ME4](#) [FF450R12ME4P](#) [FF450R17IE4](#) [FF600R12IE4V](#) [FF600R12IP4V](#) [FF800R17KP4_B2](#) [FF900R12IE4V](#) [MIXA30W1200TED](#) [MIXA450PF1200TSF](#) [FP06R12W1T4_B3](#) [FP100R07N3E4](#) [FP100R07N3E4_B11](#) [FP10R06W1E3_B11](#) [FP10R12W1T4_B11](#) [FP10R12YT3](#) [FP10R12YT3_B4](#) [FP150R07N3E4](#) [FP15R12KT3](#) [FP15R12W2T4](#)