

# SKiiP 12AC12T4V1



MiniSKiiP® 1

## SKiiP 12AC12T4V1

### Features

- Trench 4 IGBT's
- Robust and soft freewheeling diodes in CAL technology
- Highly reliable spring contacts for electrical connections
- UL recognised file no. E63532

### Typical Applications\*

- Inverter up to 12 kVA
- Typical motor power 5,5 kW

### Remarks

- $V_{CEsat}$ ,  $V_F$  = chip level value
- Case temp. limited to  $T_C = 125^\circ\text{C}$  max. (for baseplateless modules  $T_C = T_S$ )
- product rel. results valid for  $T_j \leq 150$  (recomm.  $T_{op} = -40 \dots +150^\circ\text{C}$ )

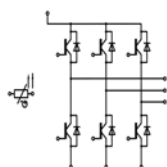

AC

### Absolute Maximum Ratings

Symbol	Conditions	Values	Unit
<b>Inverter - IGBT</b>			
$V_{CES}$	$T_j = 25^\circ\text{C}$	1200	V
$I_C$	$T_j = 175^\circ\text{C}$	$T_s = 25^\circ\text{C}$	18
		$T_s = 70^\circ\text{C}$	18
$I_{Cnom}$		15	A
$I_{CRM}$	$I_{CRM} = 3 \times I_{Cnom}$	45	A
$V_{GES}$		-20 ... 20	V
$t_{psc}$	$V_{CC} = 800\text{ V}$	$T_j = 150^\circ\text{C}$	10
	$V_{GE} \leq 15\text{ V}$		
	$V_{CES} \leq 1200\text{ V}$		
$T_j$		-40 ... 175	$^\circ\text{C}$
<b>Inverse - Diode</b>			
$I_F$	$T_j = 175^\circ\text{C}$	$T_s = 25^\circ\text{C}$	23
		$T_s = 70^\circ\text{C}$	18
$I_{Fnom}$		15	A
$I_{FRM}$	$I_{FRM} = 3 \times I_{Fnom}$	45	A
$I_{FSM}$	10 ms, sin 180°, $T_j = 150^\circ\text{C}$	65	A
$T_j$		-40 ... 175	$^\circ\text{C}$
<b>Module</b>			
$I_{t(RMS)}$	$T_{terminal} = 80^\circ\text{C}$ , 20A per spring	20	A
$T_{stg}$		-40 ... 125	$^\circ\text{C}$
$V_{isol}$	AC sinus 50Hz, t = 1 min	2500	V

### Characteristics

Symbol	Conditions	min.	typ.	max.	Unit
<b>Inverter - IGBT</b>					
$V_{CE(sat)}$	$I_C = 15\text{ A}$ $V_{GE} = 15\text{ V}$ chiplevel	$T_j = 25^\circ\text{C}$	1.85	2.10	V
		$T_j = 150^\circ\text{C}$	2.25	2.45	V
$V_{CE0}$		$T_j = 25^\circ\text{C}$	0.8	0.9	V
		$T_j = 150^\circ\text{C}$	0.7	0.8	V
$r_{CE}$	$V_{GE} = 15\text{ V}$	$T_j = 25^\circ\text{C}$	70	80	m $\Omega$
		$T_j = 150^\circ\text{C}$	103	110	m $\Omega$
$V_{GE(th)}$	$V_{GE} = V_{CE}$ , $I_C = 1\text{ mA}$	5	5.8	6.5	V
$I_{CES}$	$V_{GE} = 0\text{ V}$ $V_{CE} = 1200\text{ V}$	$T_j = 25^\circ\text{C}$	0.1	0.3	mA
					mA
$C_{ies}$	$V_{CE} = 25\text{ V}$		0.90		nF
$C_{oes}$	$V_{GE} = 0\text{ V}$		0.08		nF
$C_{res}$			0.06		nF
$Q_G$	- 8 V...+ 15 V		85		nC
$R_{Gint}$	$T_j = 25^\circ\text{C}$		0.00		$\Omega$
$t_{d(on)}$	$V_{CC} = 600\text{ V}$	$T_j = 150^\circ\text{C}$	31		ns
$t_r$	$I_C = 15\text{ A}$	$T_j = 150^\circ\text{C}$	30		ns
$E_{on}$	$R_{Gon} = 39\ \Omega$ $R_{Goff} = 39\ \Omega$	$T_j = 150^\circ\text{C}$	1.65		mJ
$t_{d(off)}$	$di/dt_{on} = 400\text{ A}/\mu\text{s}$	$T_j = 150^\circ\text{C}$	315		ns
$t_f$	$di/dt_{off} = 200\text{ A}/\mu\text{s}$	$T_j = 150^\circ\text{C}$	66		ns
$E_{off}$	$V_{GE} = +15/-15\text{ V}$	$T_j = 150^\circ\text{C}$	1.5		mJ
$R_{th(j-s)}$	per IGBT		1.3		K/W

# SKiiP 12AC12T4V1

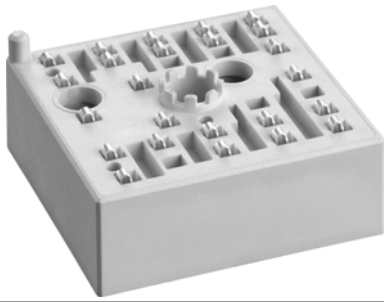

MiniSKiiP® 1

## SKiiP 12AC12T4V1

### Features

- Trench 4 IGBT's
- Robust and soft freewheeling diodes in CAL technology
- Highly reliable spring contacts for electrical connections
- UL recognised file no. E63532

### Typical Applications\*

- Inverter up to 12 kVA
- Typical motor power 5,5 kW

### Remarks

- $V_{CEsat}$ ,  $V_F$  = chip level value
- Case temp. limited to  $T_C = 125^\circ\text{C}$  max. (for baseplateless modules  $T_C = T_S$ )
- product rel. results valid for  $T_j \leq 150$  (recomm.  $T_{op} = -40 \dots +150^\circ\text{C}$ )

Characteristics						
Symbol	Conditions		min.	typ.	max.	Unit
<b>Inverse - Diode</b>						
$V_F = V_{EC}$	$I_F = 15 \text{ A}$ $V_{GE} = 0 \text{ V}$ chiplevel	$T_j = 25^\circ\text{C}$		2.4	2.7	V
		$T_j = 150^\circ\text{C}$		2.4	2.8	V
$V_{F0}$		$T_j = 25^\circ\text{C}$		1.3	1.5	V
		$T_j = 150^\circ\text{C}$		0.9	1.1	V
$r_F$		$T_j = 25^\circ\text{C}$		72	81	m $\Omega$
		$T_j = 150^\circ\text{C}$		103	111	m $\Omega$
$I_{RRM}$	$I_F = 15 \text{ A}$	$T_j = 150^\circ\text{C}$		12		A
$Q_{rr}$	$di/dt_{off} = 500 \text{ A}/\mu\text{s}$	$T_j = 150^\circ\text{C}$		2		$\mu\text{C}$
$E_{rr}$	$V_{GE} = -15 \text{ V}$ $V_{CC} = 600 \text{ V}$	$T_j = 150^\circ\text{C}$		0.79		mJ
$R_{th(j-s)}$	per Diode			1.92		K/W
<b>Module</b>						
$M_s$	to heat sink		2		2.5	Nm
w				35		g
<b>Temperatur Sensor</b>						
$R_{100}$	$T_C = 100^\circ\text{C}$ ( $R_{25} = 1000\Omega$ )			$1670 \pm 3\%$		$\Omega$
$R(T)$	$R(T) = 1000\Omega [1 + A(T - 25^\circ\text{C}) + B(T - 25^\circ\text{C})^2]$ ], $A = 7.635 \cdot 10^{-3} \text{ }^\circ\text{C}^{-1}$ , $B = 1.731 \cdot 10^{-5} \text{ }^\circ\text{C}^{-2}$					

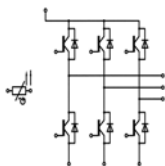

AC

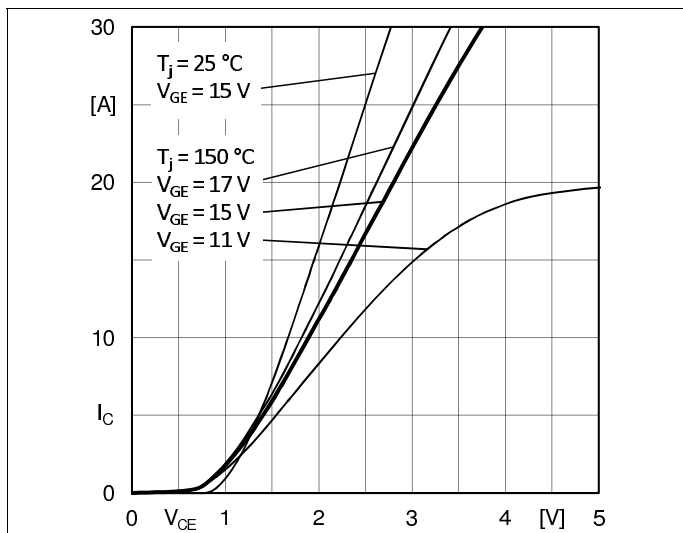

Fig. 1: Typ. output characteristic, inclusive  $R_{CC+EE}$

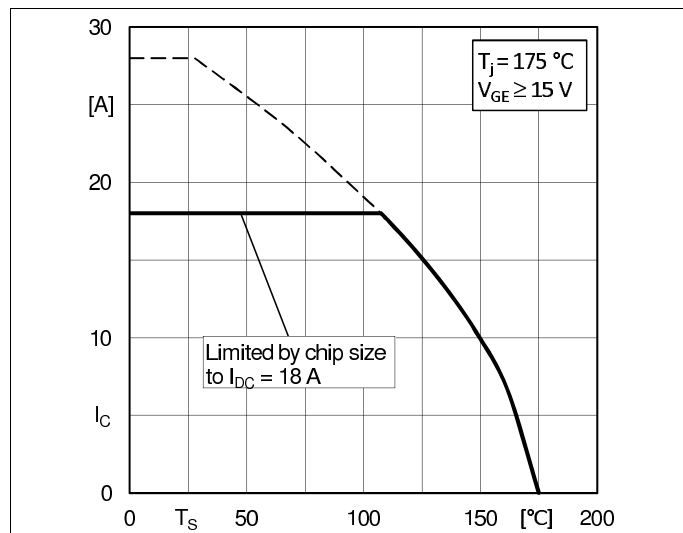

Fig. 2: Rated current vs. temperature  $I_C = f(T_S)$

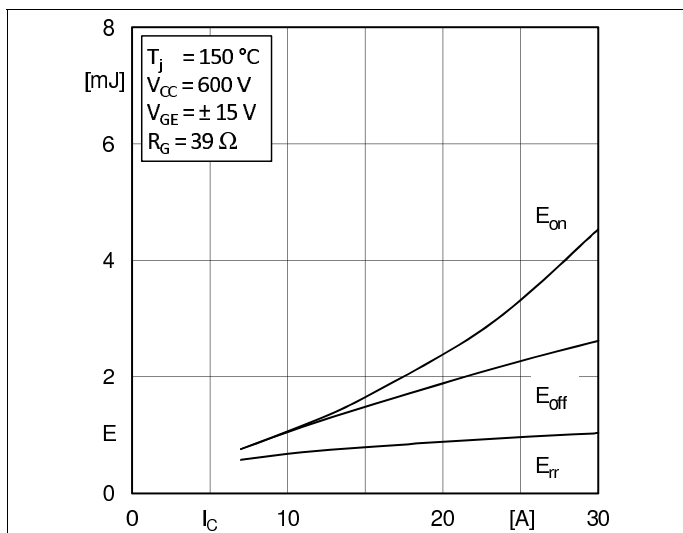

Fig. 3: Typ. turn-on /-off energy =  $f(I_C)$

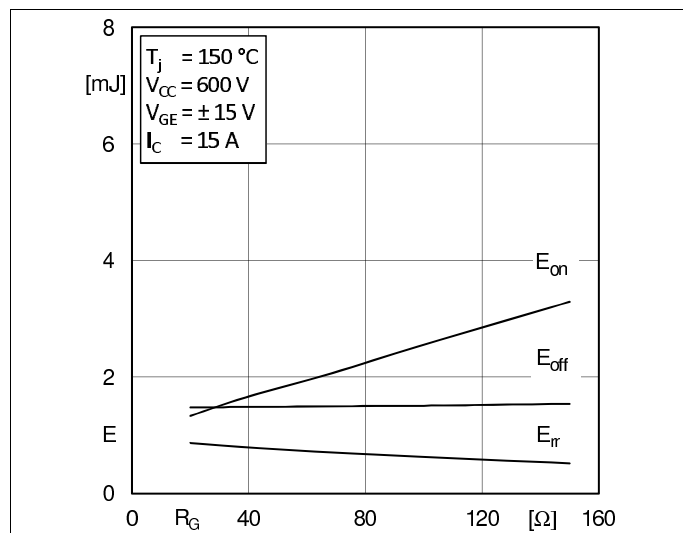

Fig. 4: Typ. turn-on /-off energy =  $f(R_G)$

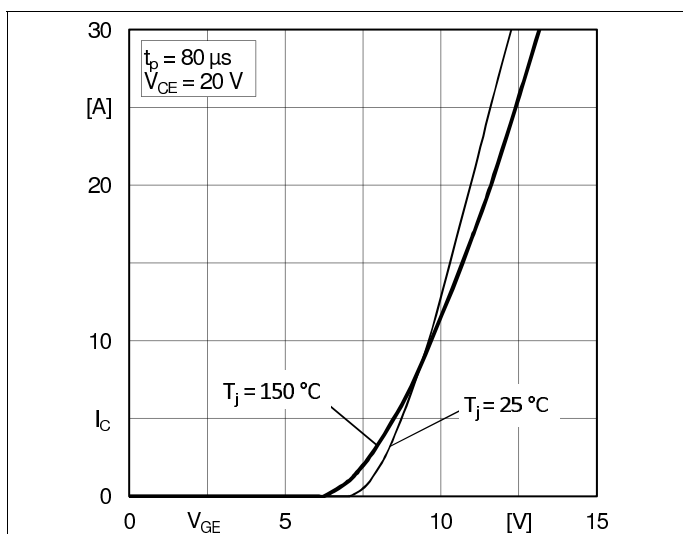

Fig. 5: Typ. transfer characteristic

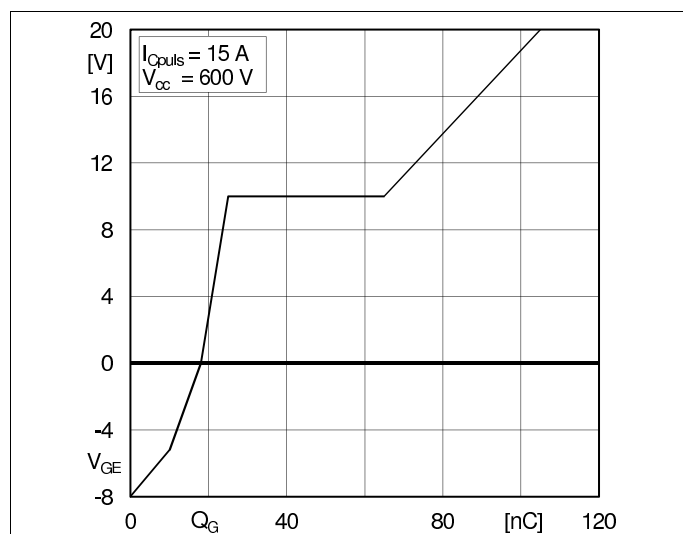

Fig. 6: Typ. gate charge characteristic

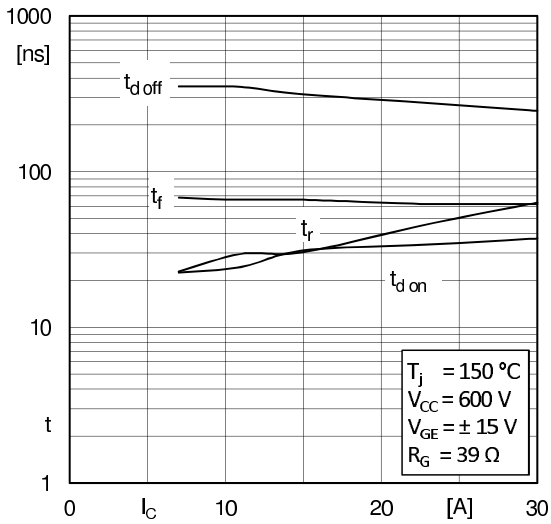

Fig. 7: Typ. switching times vs.  $I_C$

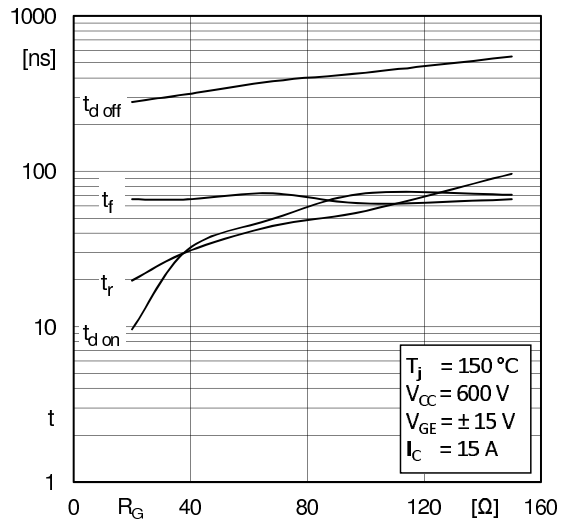

Fig. 8: Typ. switching times vs. gate resistor  $R_G$

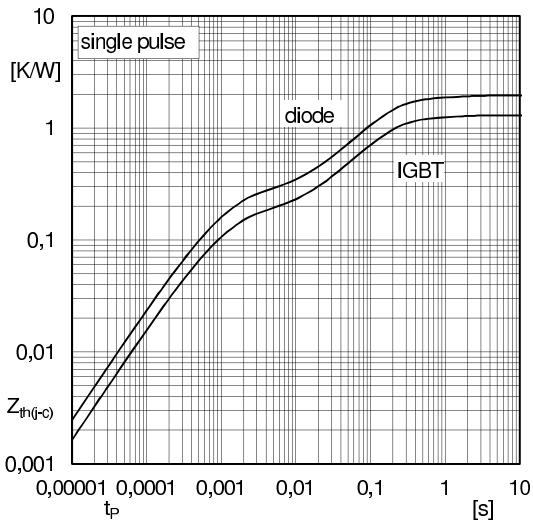

Fig. 9: Transient thermal impedance of IGBT and Diode

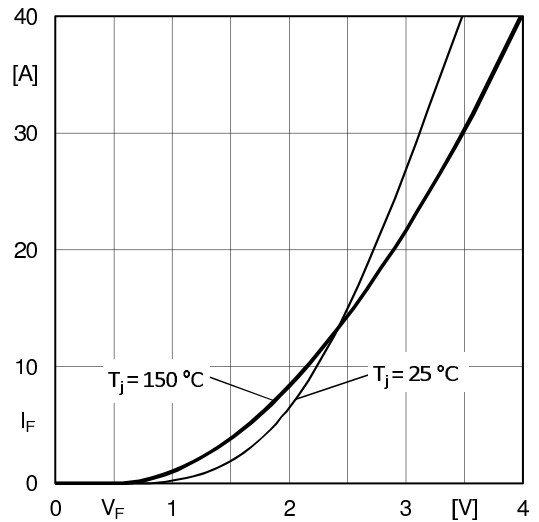

Fig. 10: CAL diode forward characteristic

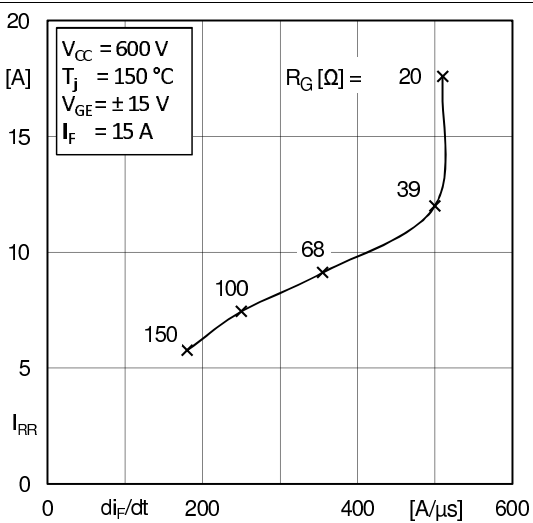

Fig. 11: Typ. CAL diode peak reverse recovery current

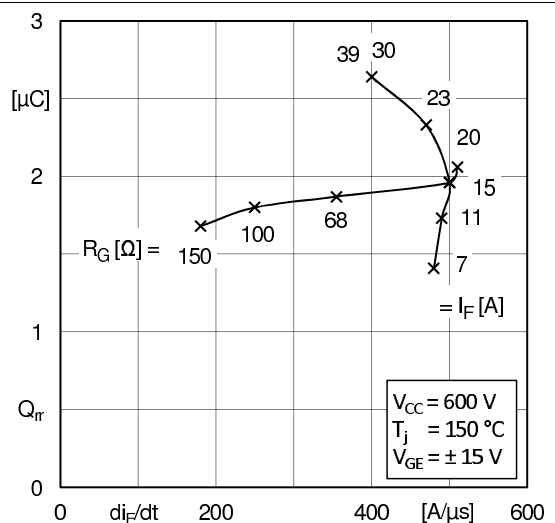
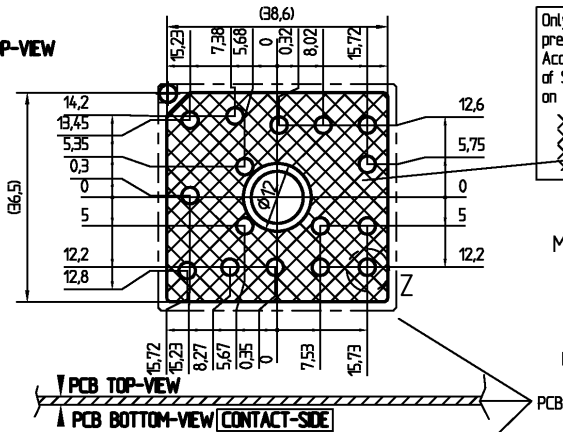
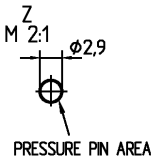
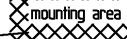

Fig. 12: Typ. CAL diode recovery charge

## PCB PCB TOP-VIEW



Only for the standard pressure part:  
Accessible for mounting of SMD (max height 3.5) on PCB by customer



## MiniSKiIP 1

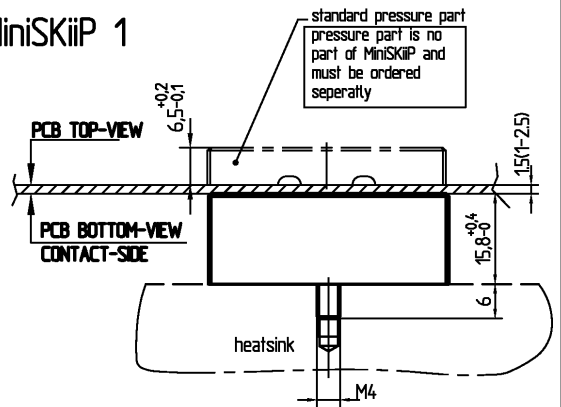

## PCB BOTTOM-VIEW CONTACT-SIDE

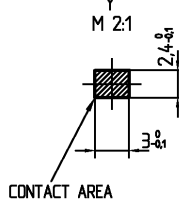
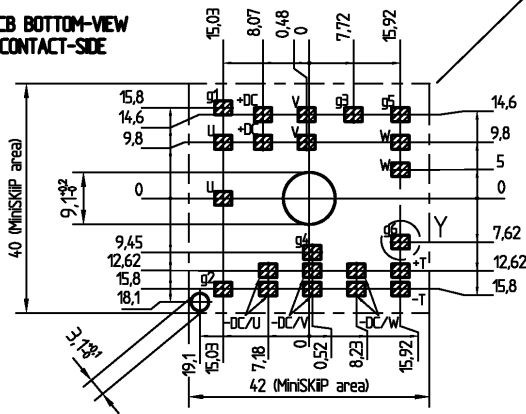

For mounting please follow the assembly instruction

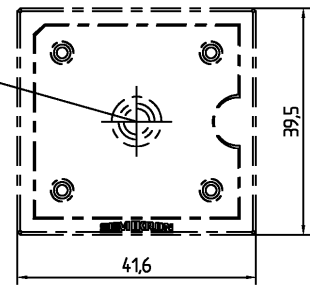

measure: mm  
tolerance: ISO 2768-f

## pinout, dimensions

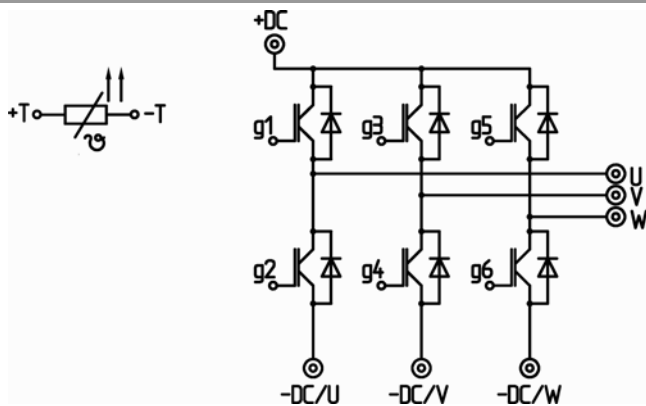

- ⊙ power connector
- control connector

## pinout

This is an electrostatic discharge sensitive device (ESDS), international standard IEC 60747-1, Chapter IX

\* The specifications of our components may not be considered as an assurance of component characteristics. Components have to be tested for the respective application. Adjustments may be necessary. The use of SEMIKRON products in life support appliances and systems is subject to prior specification and written approval by SEMIKRON. We therefore strongly recommend prior consultation of our staff.

## X-ON Electronics

Largest Supplier of Electrical and Electronic Components

*Click to view similar products for [IGBT Modules category](#):*

*Click to view products by [Semikron manufacturer](#):*

Other Similar products are found below :

[F3L100R07W2E3\\_B11](#) [F3L15R12W2H3\\_B27](#) [F3L400R07ME4\\_B22](#) [F3L400R12PT4\\_B26](#) [F4-100R12KS4](#) [F4-50R07W2H3\\_B51](#) [F4-75R12KS4\\_B11](#) [FB15R06W1E3](#) [FB20R06W1E3\\_B11](#) [FD1000R33HE3-K](#) [FD300R06KE3](#) [FD300R12KE3](#) [FD300R12KS4\\_B5](#) [FD400R12KE3](#) [FD400R33KF2C-K](#) [FD401R17KF6C\\_B2](#) [FD-DF80R12W1H3\\_B52](#) [FF100R12KS4](#) [FF1200R17KE3\\_B2](#) [FF150R12KE3G](#) [FF200R06KE3](#) [FF200R06YE3](#) [FF200R12KT3](#) [FF200R12KT3\\_E](#) [FF200R12KT4](#) [FF200R17KE3](#) [FF300R06KE3\\_B2](#) [FF300R12KE4\\_E](#) [FF300R12KS4HOSA1](#) [FF300R12ME4\\_B11](#) [FF300R12MS4](#) [FF300R17ME4](#) [FF450R12ME4P](#) [FF450R17IE4](#) [FF600R12IE4V](#) [FF600R12IP4V](#) [FF800R17KP4\\_B2](#) [FF900R12IE4V](#) [MIXA30W1200TED](#) [MIXA450PF1200TSF](#) [FP06R12W1T4\\_B3](#) [FP100R07N3E4](#) [FP100R07N3E4\\_B11](#) [FP10R06W1E3\\_B11](#) [FP10R12W1T4\\_B11](#) [FP10R12YT3](#) [FP10R12YT3\\_B4](#) [FP150R07N3E4](#) [FP15R12KT3](#) [FP15R12W2T4](#)