

SKiiP 27MLI07E3V1

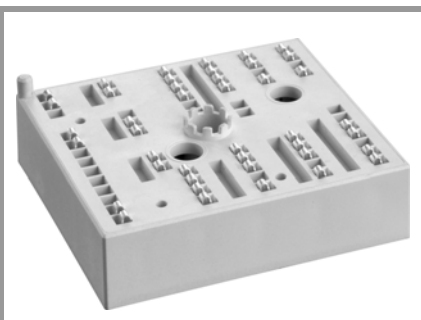

MiniSKiiP® 2

3-Level NPC Inverter

SKiiP 27MLI07E3V1

Features

- 650V Trench IGBTs
- Robust and soft diodes in CAL technology
- Highly reliable spring contacts for electrical connections
- UL recognised: File no. E63532

Typical Applications*

- Uninterruptible power supplies (UPS)
- Solar inverters

Remarks

- Case temperature limited to $T_C = 125^\circ\text{C}$ max.; $T_C = T_S$ (valid for baseplateless modules)
- Product reliability results valid for $T_j \leq 150^\circ\text{C}$ (recommended $T_{op} = -40 \dots +150^\circ\text{C}$)

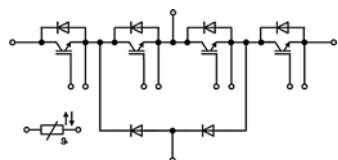

MLI

Absolute Maximum Ratings				
Symbol	Conditions		Values	Unit
IGBT				
V_{CES}			650	V
I_C	$T_j = 175^\circ\text{C}$	$T_s = 25^\circ\text{C}$	110	A
		$T_s = 70^\circ\text{C}$	88	A
I_{Cnom}			100	A
I_{CRM}	$I_{CRM} = 2 \times I_{Cnom}$		200	A
V_{GES}			-20 ... 20	V
t_{psc}	$V_{CC} = 360\text{ V}$ $V_{GE} \leq 15\text{ V}$ $V_{CES} \leq 650\text{ V}$	$T_j = 150^\circ\text{C}$	6	μs
T_j			-40 ... 175	$^\circ\text{C}$
Inverse diode				
I_F	$T_j = 175^\circ\text{C}$	$T_s = 25^\circ\text{C}$	107	A
		$T_s = 70^\circ\text{C}$	84	A
I_{Fnom}			100	A
I_{FRM}	$I_{FRM} = 2 \times I_{Fnom}$		200	A
I_{FSM}	$t_p = 10\text{ ms, sin } 180^\circ, T_j = 25^\circ\text{C}$		820	A
T_j			-40 ... 175	$^\circ\text{C}$
Clamping diode				
I_F	$T_j = 175^\circ\text{C}$	$T_s = 25^\circ\text{C}$	107	A
		$T_s = 70^\circ\text{C}$	84	A
I_{Fnom}			100	A
I_{FRM}	$I_{FRM} = 2 \times I_{Fnom}$		200	A
I_{FSM}	$10\text{ ms, sin } 180^\circ, T_j = 25^\circ\text{C}$		820	A
T_j			-40 ... 175	$^\circ\text{C}$
Module				
$I_{t(RMS)}$	$T_{terminal} = 80^\circ\text{C}, 20\text{ A per spring}$		120	A
T_{stg}			-40 ... 125	$^\circ\text{C}$
V_{isol}	AC sinus 50 Hz, $t = 1\text{ min}$		2500	V

Characteristics						
Symbol	Conditions		min.	typ.	max.	Unit
IGBT						
$V_{CE(sat)}$	$I_C = 100\text{ A}$ $V_{GE} = 15\text{ V}$ chipelevel	$T_j = 25^\circ\text{C}$	1.45	1.85		V
		$T_j = 150^\circ\text{C}$	1.70	2.10		V
V_{CE0}	chipelevel	$T_j = 25^\circ\text{C}$	0.9	1		V
		$T_j = 150^\circ\text{C}$	0.82	0.9		V
r_{CE}	$V_{GE} = 15\text{ V}$ chipelevel	$T_j = 25^\circ\text{C}$	5.5	8.5		$\text{m}\Omega$
		$T_j = 150^\circ\text{C}$	8.8	12		$\text{m}\Omega$
$V_{GE(th)}$	$V_{GE} = V_{CE}, I_C = 1.6\text{ mA}$		5	5.8	6.5	V
I_{CES}	$V_{GE} = 0\text{ V}$ $V_{CE} = 650\text{ V}$	$T_j = 25^\circ\text{C}$	0.1	0.3		mA
						mA
C_{ies}	$V_{CE} = 25\text{ V}$ $V_{GE} = 0\text{ V}$	$f = 1\text{ MHz}$	6.16			nF
C_{oes}		$f = 1\text{ MHz}$	0.38			nF
C_{res}		$f = 1\text{ MHz}$	0.18			nF
Q_G	$V_{GE} = -8\text{ V} \dots +15\text{ V}$		800			nC
R_{Gint}	$T_j = 25^\circ\text{C}$		2			Ω

SKiIP 27MLI07E3V1

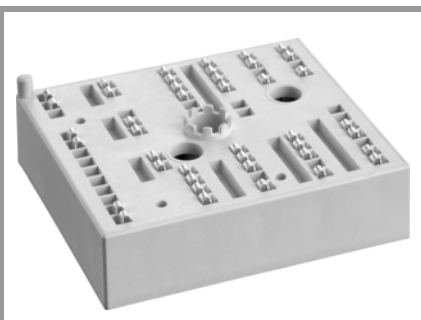

MiniSKiIP® 2

3-Level NPC Inverter

SKiIP 27MLI07E3V1

Features

- 650V Trench IGBTs
- Robust and soft diodes in CAL technology
- Highly reliable spring contacts for electrical connections
- UL recognised: File no. E63532

Typical Applications*

- Uninterruptible power supplies (UPS)
- Solar inverters

Remarks

- Case temperature limited to $T_C = 125^\circ\text{C}$ max.; $T_C = T_S$ (valid for baseplateless modules)
- Product reliability results valid for $T_j \leq 150^\circ\text{C}$ (recommended $T_{op} = -40 \dots +150^\circ\text{C}$)

Characteristics						
Symbol	Conditions		min.	typ.	max.	Unit
T1 / T4						
$t_{d(on)}$	$V_{CE} = 300\text{ V}$	$T_j = 150^\circ\text{C}$		114		ns
t_r	$I_C = 100\text{ A}$	$T_j = 150^\circ\text{C}$		59		ns
E_{on}	$V_{GE} = +15/-15\text{ V}$	$T_j = 150^\circ\text{C}$		4.2		mJ
$t_{d(off)}$	$R_{G\ on} = 4\ \Omega$	$T_j = 150^\circ\text{C}$		259		ns
t_f	$R_{G\ off} = 2.1\ \Omega$	$T_j = 150^\circ\text{C}$		66		ns
E_{off}	$di/dt_{on} = 1715\text{ A}/\mu\text{s}$	$T_j = 150^\circ\text{C}$		4.2		mJ
$R_{th(j-s)}$	per IGBT			0.6		K/W
T2 / T3						
$t_{d(on)}$	$V_{CE} = 300\text{ V}$	$T_j = 150^\circ\text{C}$		110		ns
t_r	$I_C = 100\text{ A}$	$T_j = 150^\circ\text{C}$		58		ns
E_{on}	$V_{GE} = +15/-15\text{ V}$	$T_j = 150^\circ\text{C}$		1.8		mJ
$t_{d(off)}$	$R_{G\ on} = 4\ \Omega$	$T_j = 150^\circ\text{C}$		258		ns
t_f	$R_{G\ off} = 2.1\ \Omega$	$T_j = 150^\circ\text{C}$		77		ns
E_{off}	$di/dt_{on} = 2035\text{ A}/\mu\text{s}$	$T_j = 150^\circ\text{C}$		4		mJ
$R_{th(j-s)}$				0.6		K/W
Inverse diode						
$V_F = V_{EC}$	$I_F = 100\text{ A}$	$T_j = 25^\circ\text{C}$		1.4	1.8	V
	$V_{GE} = 0\text{ V}$ chipelevel	$T_j = 150^\circ\text{C}$		1.4	1.8	V
V_{F0}	chipelevel	$T_j = 25^\circ\text{C}$		1	1.2	V
		$T_j = 150^\circ\text{C}$		0.9	1	V
r_F	chipelevel	$T_j = 25^\circ\text{C}$		3.6	5.3	m Ω
		$T_j = 150^\circ\text{C}$		5.3	7.8	m Ω
I_{RRM}	$I_F = 100\text{ A}$	$T_j = 150^\circ\text{C}$		89		A
Q_{rr}	$di/dt_{off} = 1980\text{ A}/\mu\text{s}$	$T_j = 150^\circ\text{C}$		13		μC
E_{rr}	$V_{GE} = -15\text{ V}$	$T_j = 150^\circ\text{C}$		3.5		mJ
$R_{th(j-s)}$	per Diode			0.8		K/W
Clamping diode						
$V_F = V_{EC}$	$I_F = 100\text{ A}$	$T_j = 25^\circ\text{C}$		1.4	1.8	V
	$V_{GE} = 0\text{ V}$ chipelevel	$T_j = 150^\circ\text{C}$		1.4	1.8	V
V_{F0}	chipelevel	$T_j = 25^\circ\text{C}$		1	1.2	V
		$T_j = 150^\circ\text{C}$		0.9	1	V
r_F	chipelevel	$T_j = 25^\circ\text{C}$		3.6	5.3	m Ω
		$T_j = 150^\circ\text{C}$		5.3	7.8	m Ω
I_{RRM}	$I_F = 100\text{ A}$	$T_j = 150^\circ\text{C}$		86		A
Q_{rr}	$di/dt_{off} = 1780\text{ A}/\mu\text{s}$	$T_j = 150^\circ\text{C}$		10.1		μC
E_{rr}	$V_{GE} = -15\text{ V}$	$T_j = 150^\circ\text{C}$		2		mJ
$R_{th(j-s)}$	per Diode			0.8		K/W
Module						
M_s	to heat sink		2		2.5	Nm
w	weight			55		g
Temperature Sensor						
R_{25}	NTC, $T_r = 25^\circ\text{C}^1)$			$5.0 \pm 5\%$		k Ω

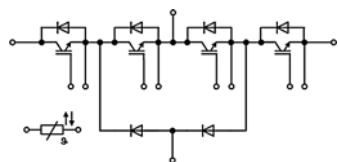

MLI

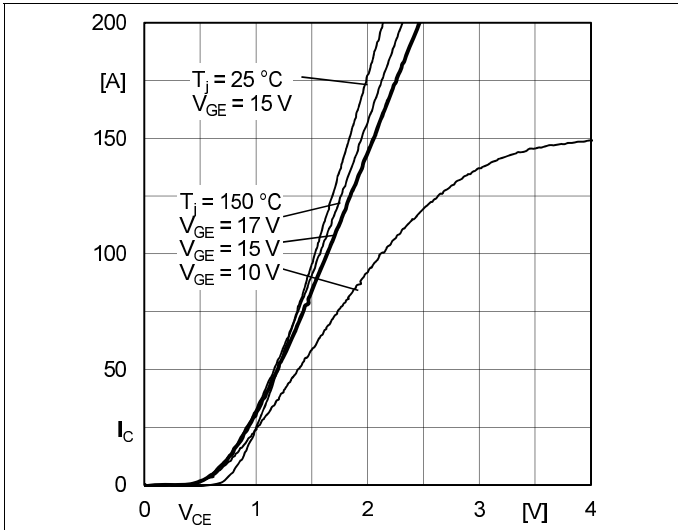

Fig. 1: Typ. output characteristic, inclusive $R_{CC'+EE'}$

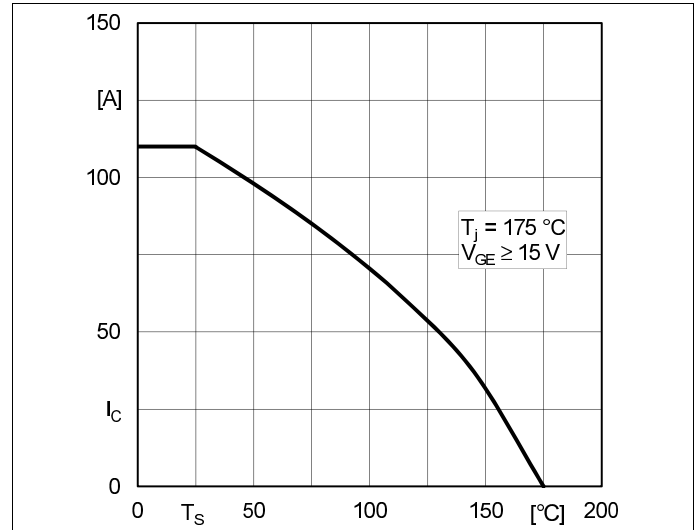

Fig. 2: Rated current vs. temperature $I_C = f(T_s)$

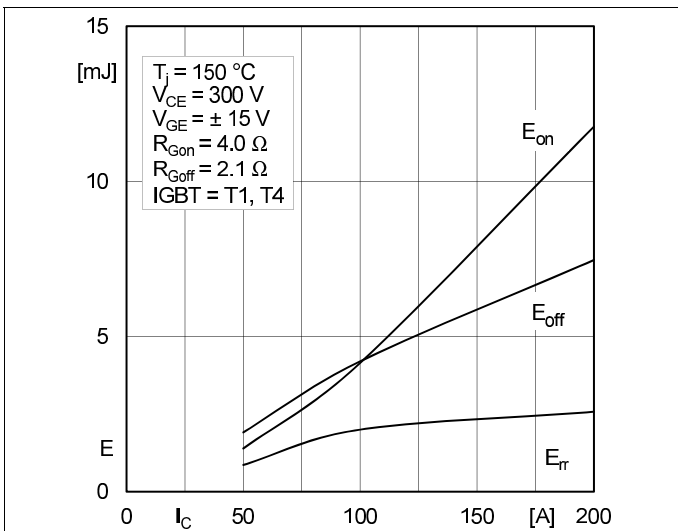

Fig. 3: Typ. turn-on /-off energy = $f(I_C)$

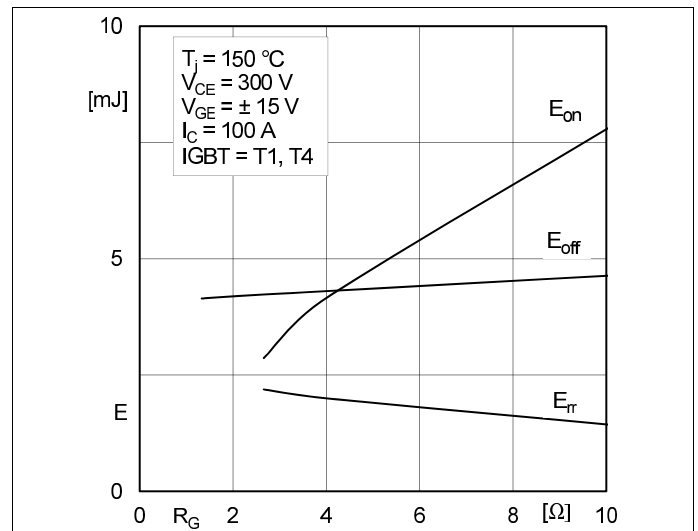

Fig. 4: Typ. turn-on /-off energy = $f(R_G)$

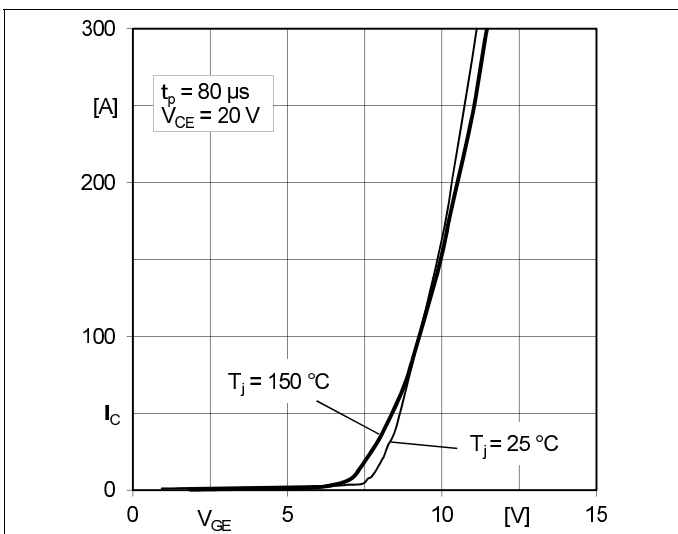

Fig. 5: Typ. transfer characteristic

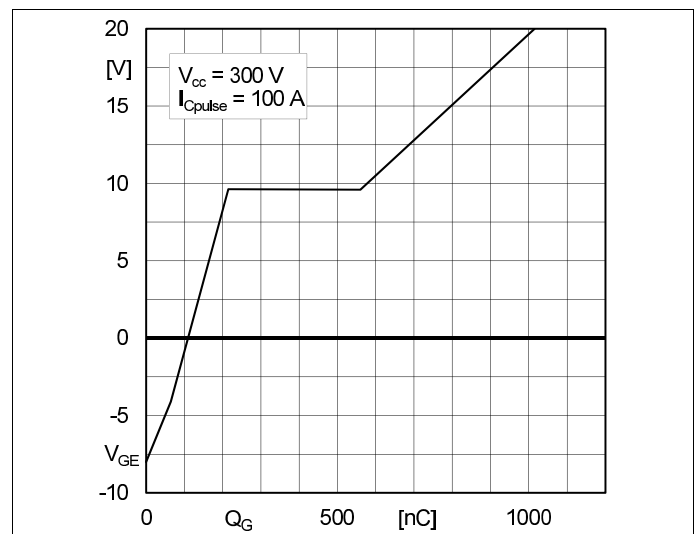
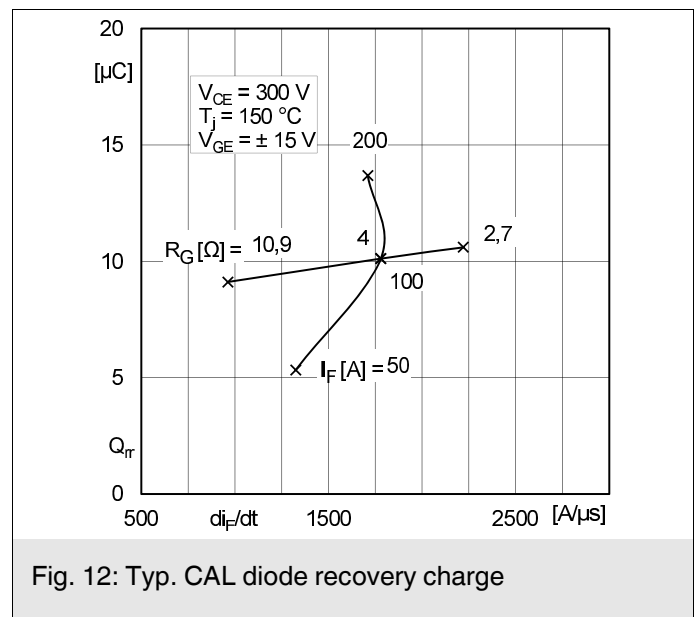
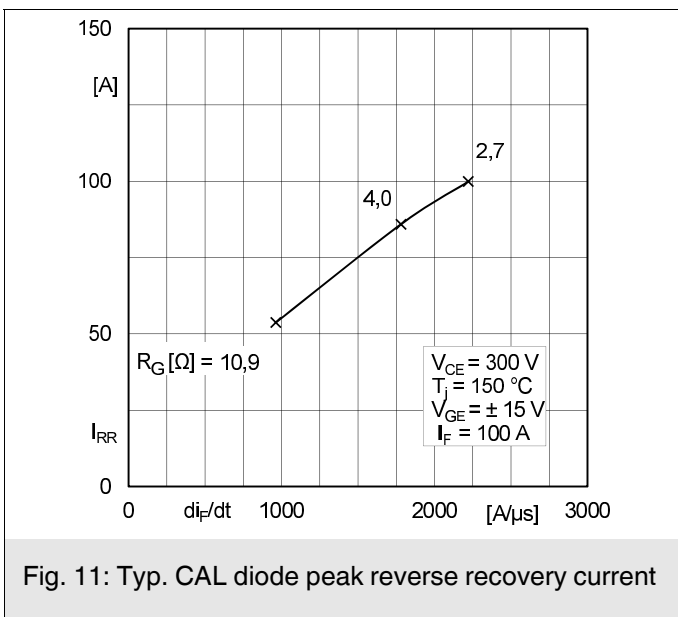
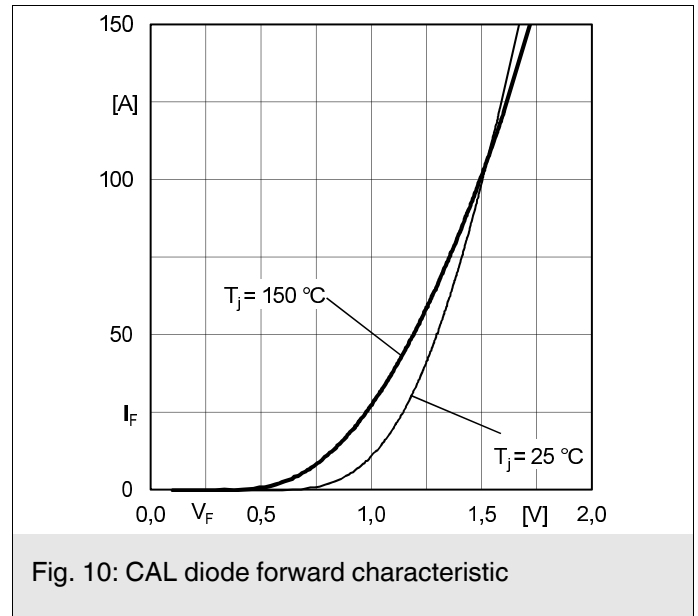
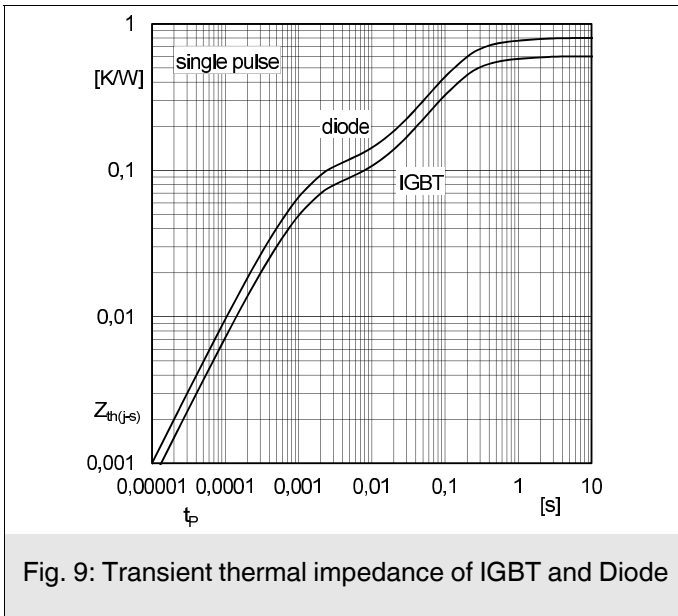
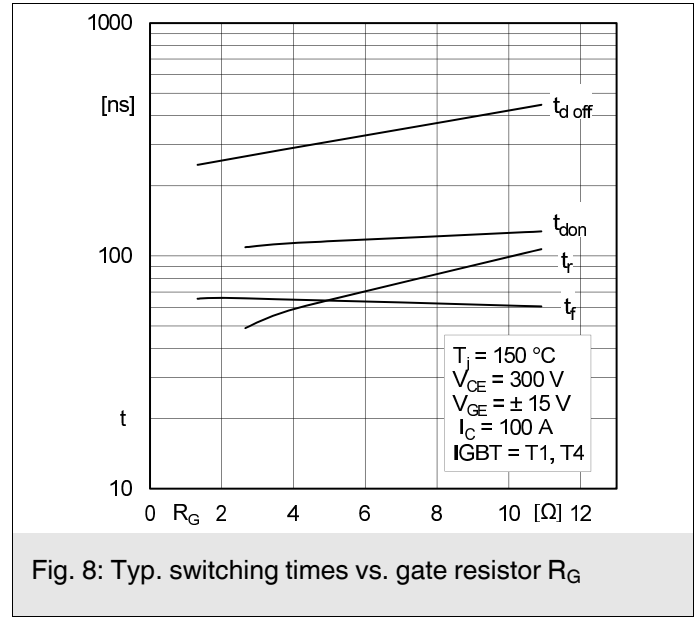
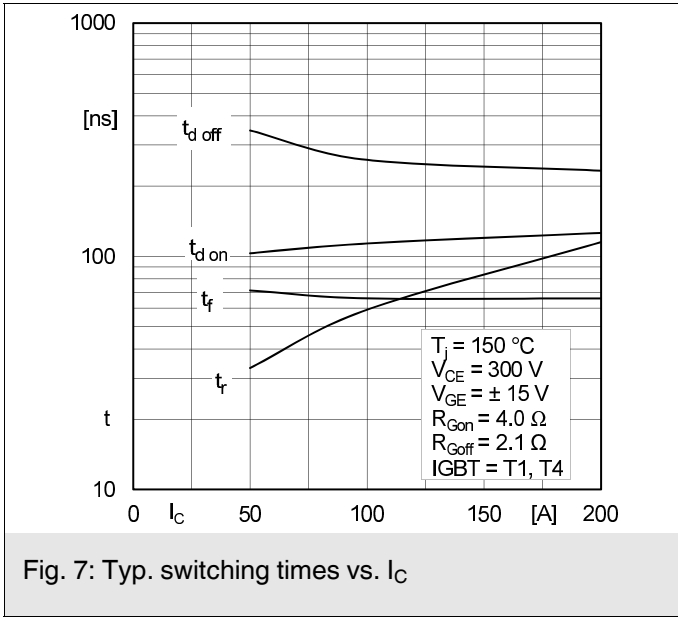
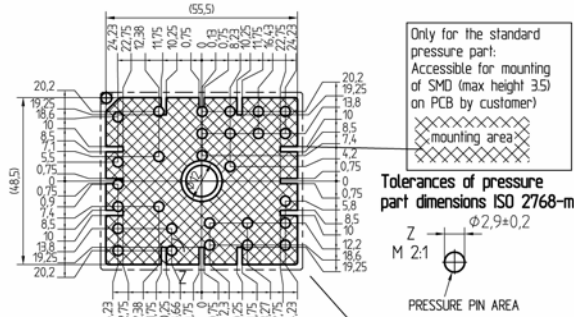

Fig. 6: Typ. gate charge characteristic



PCB PCB TOP-VIEW



MiniSKiIP 2

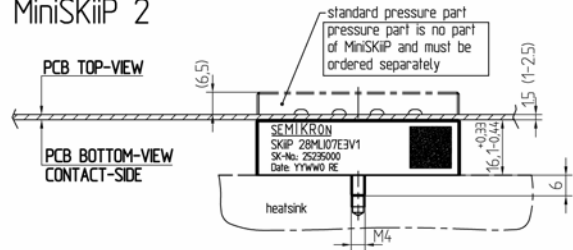

PCB TOP-VIEW PCB BOTTOM-VIEW CONTACT-SIDE ISO 2768-f

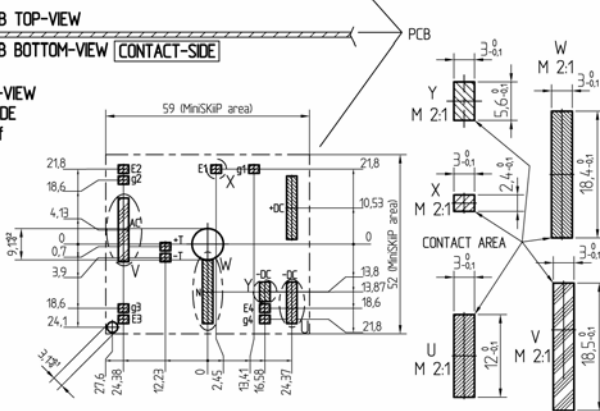

pinout, dimensions

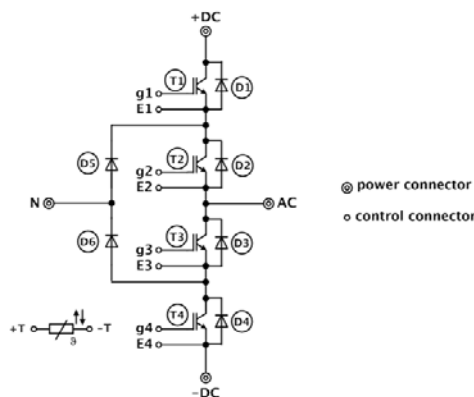

pinout

This is an electrostatic discharge sensitive device (ESDS), international standard IEC 60747-1, Chapter IX

* The specifications of our components may not be considered as an assurance of component characteristics. Components have to be tested for the respective application. Adjustments may be necessary. The use of SEMIKRON products in life support appliances and systems is subject to prior specification and written approval by SEMIKRON. We therefore strongly recommend prior consultation of our staff.

X-ON Electronics

Largest Supplier of Electrical and Electronic Components

Click to view similar products for [IGBT Modules category](#):

Click to view products by [Semikron manufacturer](#):

Other Similar products are found below :

[F3L100R07W2E3_B11](#) [F3L15R12W2H3_B27](#) [F3L400R07ME4_B22](#) [F3L400R12PT4_B26](#) [F4-100R12KS4](#) [F4-50R07W2H3_B51](#) [F4-75R12KS4_B11](#) [FB15R06W1E3](#) [FB20R06W1E3_B11](#) [FD1000R33HE3-K](#) [FD300R06KE3](#) [FD300R12KE3](#) [FD300R12KS4_B5](#) [FD400R12KE3](#) [FD400R33KF2C-K](#) [FD401R17KF6C_B2](#) [FD-DF80R12W1H3_B52](#) [FF100R12KS4](#) [FF1200R17KE3_B2](#) [FF150R12KE3G](#) [FF200R06KE3](#) [FF200R06YE3](#) [FF200R12KT3](#) [FF200R12KT3_E](#) [FF200R12KT4](#) [FF200R17KE3](#) [FF300R06KE3_B2](#) [FF300R12KE4_E](#) [FF300R12KS4HOSA1](#) [FF300R12ME4_B11](#) [FF300R12MS4](#) [FF300R17ME4](#) [FF450R12ME4P](#) [FF450R17IE4](#) [FF600R12IE4V](#) [FF600R12IP4V](#) [FF800R17KP4_B2](#) [FF900R12IE4V](#) [MIXA30W1200TED](#) [MIXA450PF1200TSF](#) [FP06R12W1T4_B3](#) [FP100R07N3E4](#) [FP100R07N3E4_B11](#) [FP10R06W1E3_B11](#) [FP10R12W1T4_B11](#) [FP10R12YT3](#) [FP10R12YT3_B4](#) [FP150R07N3E4](#) [FP15R12KT3](#) [FP15R12W2T4](#)