

# SKiIP 28ANB18V3

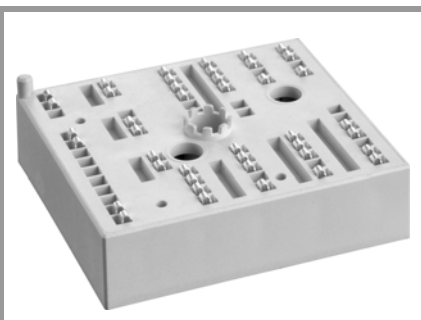

MiniSKiIP® 2

3-phase bridge rectifier +  
brake chopper

## SKiIP 28ANB18V3

### Features

- Trench IGBTs
- Robust and soft freewheeling diodes in CAL technology
- Highly reliable spring contacts for electrical connections
- UL recognised: File no. E63532

### Remarks

- Max. case temperature limited to  $T_C=125^{\circ}\text{C}$
- Product reliability results valid for  $T_j \leq 150^{\circ}\text{C}$  (recommended  $T_{j,op} = -40 \dots +150^{\circ}\text{C}$ )
- IGBT 1: brake chopper IGBT
- Diode 1: brake chopper diode
- Diode 4: rectifier diode
- The distance between terminals of temperature sensor and -rect is not sufficient for basic insulation

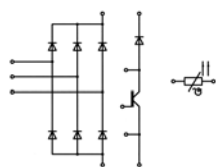

ANB

Absolute Maximum Ratings				
Symbol	Conditions	Values	Unit	
<b>IGBT 1</b>				
$V_{CES}$	$T_j = 25^{\circ}\text{C}$	1700	V	
$I_C$	$T_j = 150^{\circ}\text{C}$	$T_s = 25^{\circ}\text{C}$	115	A
		$T_s = 70^{\circ}\text{C}$	88	A
$I_C$	$T_j = 175^{\circ}\text{C}$	$T_s = 25^{\circ}\text{C}$	128	A
		$T_s = 70^{\circ}\text{C}$	104	A
$I_{Cnom}$		100	A	
$I_{CRM}$	$I_{CRM} = 2 \times I_{Cnom}$	200	A	
$V_{GES}$		-20 ... 20	V	
$t_{psc}$	$V_{CC} = 1200\text{ V}$ $V_{GE} \leq 20\text{ V}$ $V_{CES} \leq 1700\text{ V}$	$T_j = 150^{\circ}\text{C}$	10	$\mu\text{s}$
$T_j$		-40 ... 175	$^{\circ}\text{C}$	

Absolute Maximum Ratings				
Symbol	Conditions	Values	Unit	
<b>Diode 1</b>				
$V_{RRM}$	$T_j = 25^{\circ}\text{C}$	1700	V	
$I_F$	$T_j = 150^{\circ}\text{C}$	$T_s = 25^{\circ}\text{C}$	105	A
		$T_s = 70^{\circ}\text{C}$	76	A
$I_F$	$T_j = 175^{\circ}\text{C}$	$T_s = 25^{\circ}\text{C}$	119	A
		$T_s = 70^{\circ}\text{C}$	93	A
$I_{Fnom}$		150	A	
$I_{FRM}$	$I_{FRM} = 2 \times I_{Fnom}$	300	A	
$I_{FSM}$	10 ms, sin 180°, $T_j = 150^{\circ}\text{C}$	860	A	
$T_j$		-40 ... 175	$^{\circ}\text{C}$	

Absolute Maximum Ratings				
Symbol	Conditions	Values	Unit	
<b>Diode 4</b>				
$V_{RRM}$		1800	V	
$I_F$	$T_j = 150^{\circ}\text{C}$	$T_s = 25^{\circ}\text{C}$	139	A
		$T_s = 70^{\circ}\text{C}$	98	A
$I_{Fnom}$	DC current	88	A	
$I_{FSM}$	10 ms, sin 180°, $T_j = 150^{\circ}\text{C}$	890	A	
$I^2t$	10 ms, sin. 180°, $T_j = 150^{\circ}\text{C}$	3900	$\text{A}^2\text{s}$	
$T_j$		-40 ... 150	$^{\circ}\text{C}$	

Absolute Maximum Ratings			
Symbol	Conditions	Values	Unit
<b>Module</b>			
$I_{t(RMS)}$	$T_{terminal} = 80^{\circ}\text{C}$ , 20 A per spring	80	A
$T_{stg}$		-40 ... 125	$^{\circ}\text{C}$
$V_{isol}$	AC sinus 50 Hz, $t = 1\text{ min}$	2500	V

# SKiiP 28ANB18V3

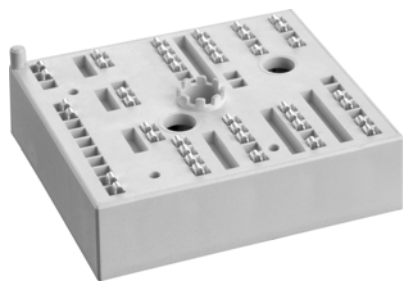

MiniSKiiP® 2

## 3-phase bridge rectifier + brake chopper

### SKiiP 28ANB18V3

#### Features

- Trench IGBTs
- Robust and soft freewheeling diodes in CAL technology
- Highly reliable spring contacts for electrical connections
- UL recognised: File no. E63532

#### Remarks

- Max. case temperature limited to  $T_C=125^\circ\text{C}$
- Product reliability results valid for  $T_j \leq 150^\circ\text{C}$  (recommended  $T_{j,op} = -40 \dots +150^\circ\text{C}$ )
- IGBT 1: brake chopper IGBT
- Diode 1: brake chopper diode
- Diode 4: rectifier diode
- The distance between terminals of temperature sensor and -rect is not sufficient for basic insulation

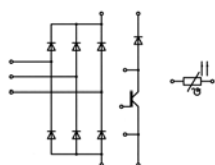

ANB

Characteristics						
Symbol	Conditions		min.	typ.	max.	Unit
<b>IGBT 1</b>						
$V_{CE(sat)}$	$I_C = 100\text{ A}$ $V_{GE} = 15\text{ V}$ chiplevel	$T_j = 25^\circ\text{C}$		2.00	2.40	V
		$T_j = 150^\circ\text{C}$		2.45	2.90	V
$V_{CE0}$	chiplevel	$T_j = 25^\circ\text{C}$		1	1.2	V
		$T_j = 150^\circ\text{C}$		0.9	1.1	V
$r_{CE}$	$V_{GE} = 15\text{ V}$ chiplevel	$T_j = 25^\circ\text{C}$		10	12	m $\Omega$
		$T_j = 150^\circ\text{C}$		16	18	m $\Omega$
$V_{GE(th)}$	$V_{GE} = V_{CE}\text{ V}, I_C = 4\text{ mA}$		5.2	5.8	6.4	V
$I_{CES}$	$V_{GE} = 0\text{ V}$	$T_j = 25^\circ\text{C}$		0.1	0.3	mA
	$V_{CE} = 1700\text{ V}$					mA
$C_{ies}$	$V_{CE} = 25\text{ V}$ $V_{GE} = 0\text{ V}$	$f = 1\text{ MHz}$		8.82		nF
$C_{oes}$		$f = 1\text{ MHz}$		0.37		nF
$C_{res}$		$f = 1\text{ MHz}$		0.29		nF
$Q_G$	$-8\text{ V} \dots +15\text{ V}$			934		nC
$R_{Gint}$	$T_j = 25^\circ\text{C}$			4.8		$\Omega$
$t_{d(on)}$	$V_{CC} = 900\text{ V}$	$T_j = 150^\circ\text{C}$		160		ns
$t_r$	$I_C = 100\text{ A}$	$T_j = 150^\circ\text{C}$		35		ns
$E_{on}$	$R_{G on} = 1\ \Omega$	$T_j = 150^\circ\text{C}$		23		mJ
$t_{d(off)}$	$R_{G off} = 1\ \Omega$	$T_j = 150^\circ\text{C}$		580		ns
$t_f$	$di/dt_{on} = 3000\text{ A}/\mu\text{s}$	$T_j = 150^\circ\text{C}$		150		ns
$E_{off}$	$V_{GE neg} = -15\text{ V}$	$T_j = 150^\circ\text{C}$		32.7		mJ
	$V_{GE pos} = 15\text{ V}$					
$R_{th(j-s)}$	per IGBT, $\lambda_{paste} = 0.8\text{ W}/\text{K}^*\text{m}$			0.33		K/W

Characteristics						
Symbol	Conditions		min.	typ.	max.	Unit
<b>Diode 1</b>						
$V_F = V_{EC}$	$I_F = 100\text{ A}$ $V_{GE} = 0\text{ V}$ chiplevel	$T_j = 25^\circ\text{C}$		1.8	2.1	V
		$T_j = 150^\circ\text{C}$		1.8	2.1	V
$V_{F0}$	chiplevel	$T_j = 25^\circ\text{C}$		1.3	1.6	V
		$T_j = 150^\circ\text{C}$		1.1	1.2	V
$r_F$	chiplevel	$T_j = 25^\circ\text{C}$		4.4	5.4	m $\Omega$
		$T_j = 150^\circ\text{C}$		6.9	8.7	m $\Omega$
$I_{RRM}$	$I_F = 100\text{ A}$	$T_j = 150^\circ\text{C}$		226		A
$Q_{rr}$	$di/dt_{off} = 4000\text{ A}/\mu\text{s}$	$T_j = 150^\circ\text{C}$		38.5		$\mu\text{C}$
$E_{rr}$	$V_{GE} = -15\text{ V}$	$T_j = 150^\circ\text{C}$		26.4		mJ
$R_{th(j-s)}$	per Diode, $\lambda_{paste} = 0.8\text{ W}/\text{K}^*\text{m}$			0.58		K/W

Characteristics						
Symbol	Conditions		min.	typ.	max.	Unit
<b>Diode 4</b>						
$V_F = V_{EC}$	$I_F = 88\text{ A}$ $V_{GE} = 0\text{ V}$ chiplevel	$T_j = 25^\circ\text{C}$		1.1	1.3	V
		$T_j = 125^\circ\text{C}$		1	1.3	V
$V_{F0}$	chiplevel	$T_j = 25^\circ\text{C}$	0.6	0.9	1.1	V
		$T_j = 125^\circ\text{C}$		0.7	1	V
$r_F$	chiplevel	$T_j = 25^\circ\text{C}$		2.3	2.6	m $\Omega$
		$T_j = 125^\circ\text{C}$		3	3.3	m $\Omega$
$R_{th(j-s)}$	per Diode, $\lambda_{paste} = 0.8\text{ W}/\text{K}^*\text{m}$			0.64		K/W

# SKiIP 28ANB18V3

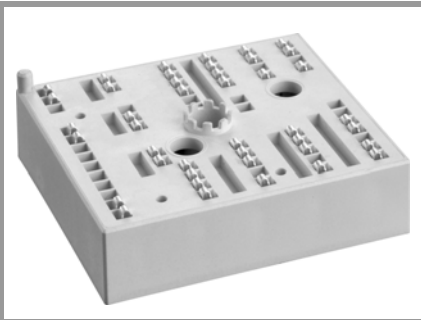

MiniSKiIP® 2

3-phase bridge rectifier +  
brake chopper

## SKiIP 28ANB18V3

### Features

- Trench IGBTs
- Robust and soft freewheeling diodes in CAL technology
- Highly reliable spring contacts for electrical connections
- UL recognised: File no. E63532

### Remarks

- Max. case temperature limited to  $T_C=125^{\circ}\text{C}$
- Product reliability results valid for  $T_j \leq 150^{\circ}\text{C}$  (recommended  $T_{j,op} = -40 \dots +150^{\circ}\text{C}$ )
- IGBT 1: brake chopper IGBT
- Diode 1: brake chopper diode
- Diode 4: rectifier diode
- The distance between terminals of temperature sensor and -rect is not sufficient for basic insulation

Characteristics					
Symbol	Conditions	min.	typ.	max.	Unit
<b>Temperature Sensor</b>					
$R_{100}$	$T_r=100^{\circ}\text{C}$ ( $R_{25}=1000\Omega$ )		$1670 \pm 3\%$		$\Omega$
$R(T)$	$R(T)=1000\Omega[1+A(T-25^{\circ}\text{C})+B(T-25^{\circ}\text{C})^2]$ ], $A = 7.635 \cdot 10^{-3} \text{ }^{\circ}\text{C}^{-1}$ , $B = 1.731 \cdot 10^{-5} \text{ }^{\circ}\text{C}^{-2}$				

Characteristics					
Symbol	Conditions	min.	typ.	max.	Unit
<b>Module</b>					
$M_s$	to heat sink	2		2.5	Nm
w	weight		55		g

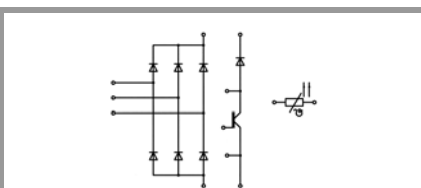

ANB

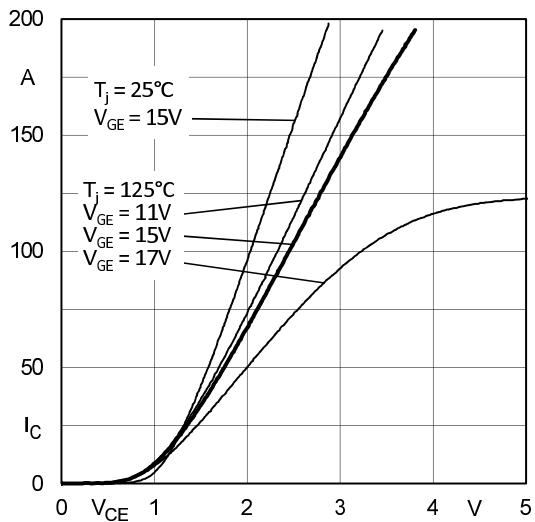

Fig. 1: Typ. output characteristic, inclusive  $R_{CC'+EE'}$

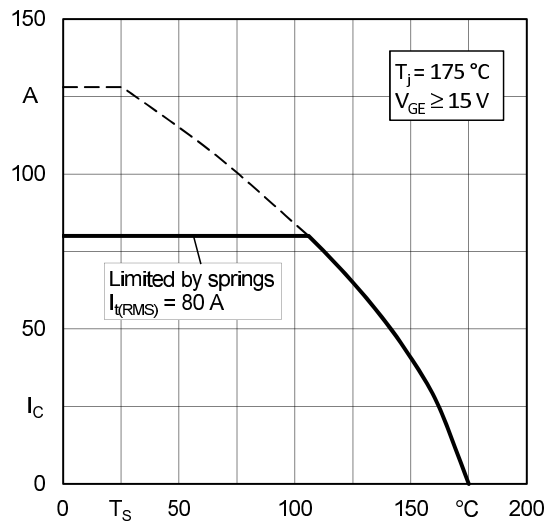

Fig. 2: Typ. rated current vs. temperature  $I_C = f(T_s)$

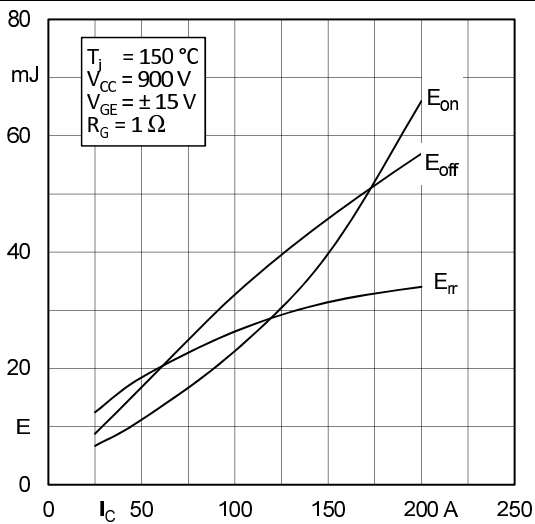

Fig. 3: Typ. turn-on /-off energy =  $f(I_C)$

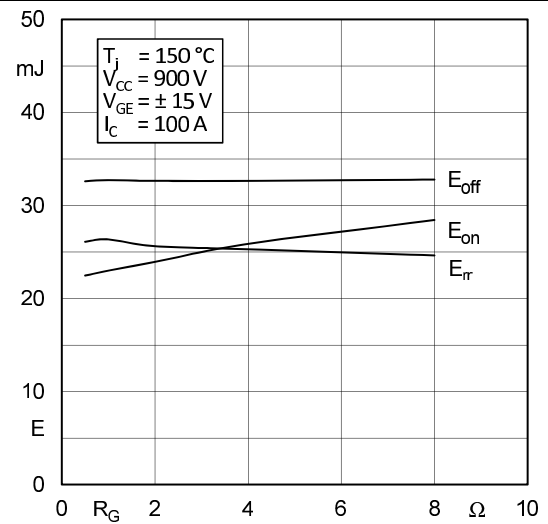

Fig. 4: Typ. turn-on /-off energy =  $f(R_G)$

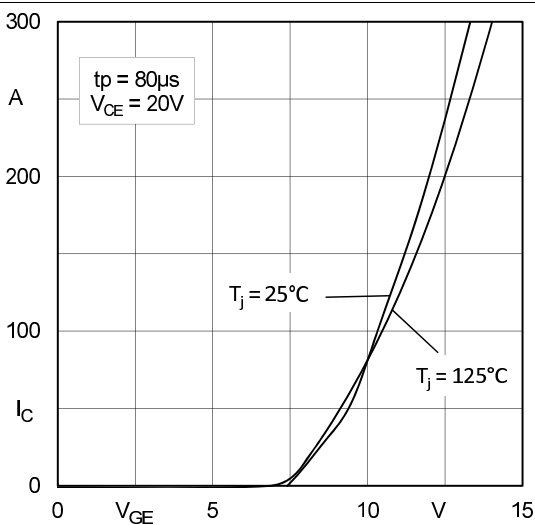

Fig. 5: Typ. transfer characteristic

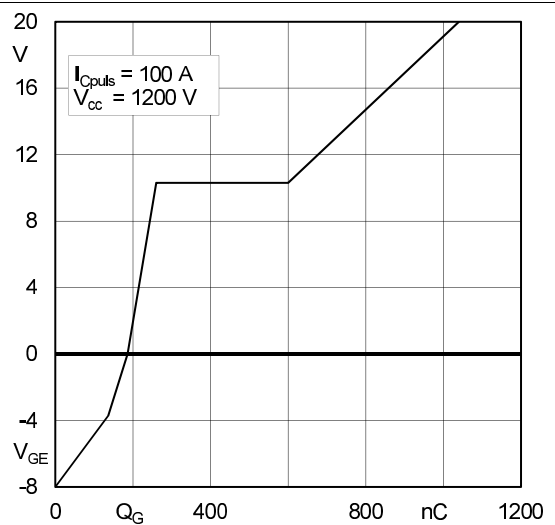

Fig. 6: Typ. gate charge characteristic

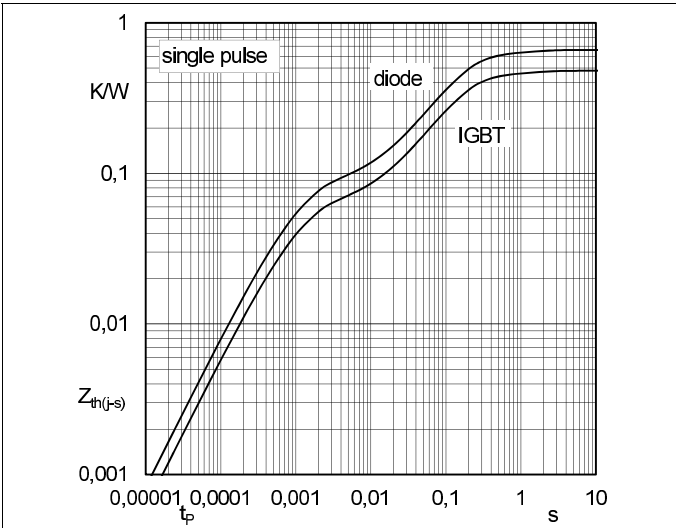

Fig. 7: Transient thermal impedance of IGBT and Diode

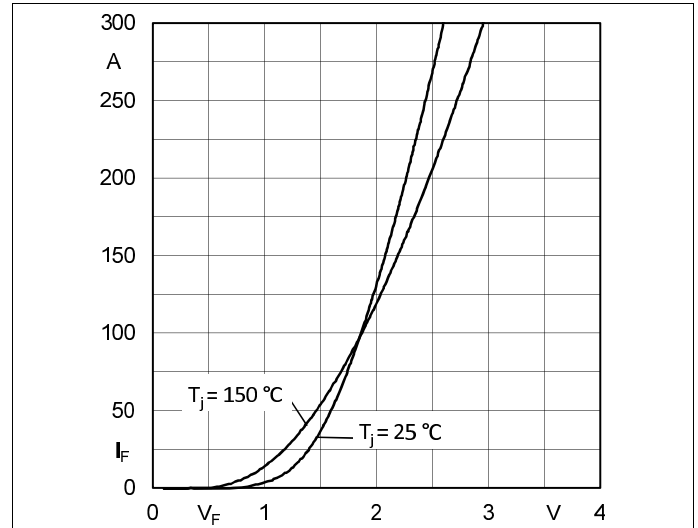

Fig. 8: CAL diode forward characteristic

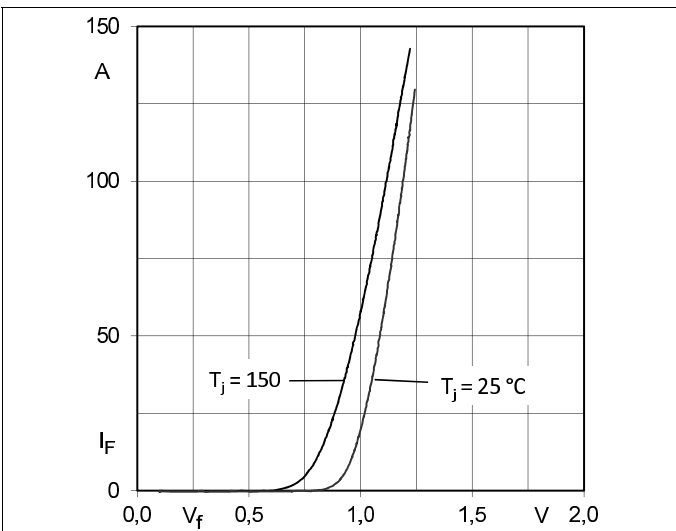
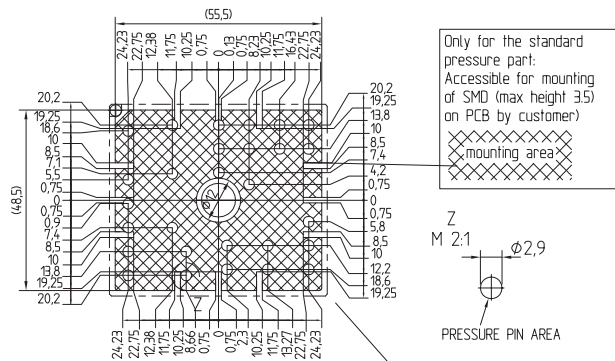
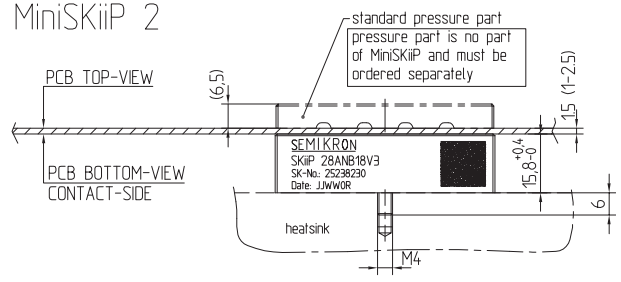

Fig. 9: Typ. input bridge forward characteristic

## PCB PCB TOP-VIEW



## MiniSKiIP 2



## PCB TOP-VIEW PCB BOTTOM-VIEW CONTACT-SIDE

## PCB BOTTOM-VIEW CONTACT-SIDE

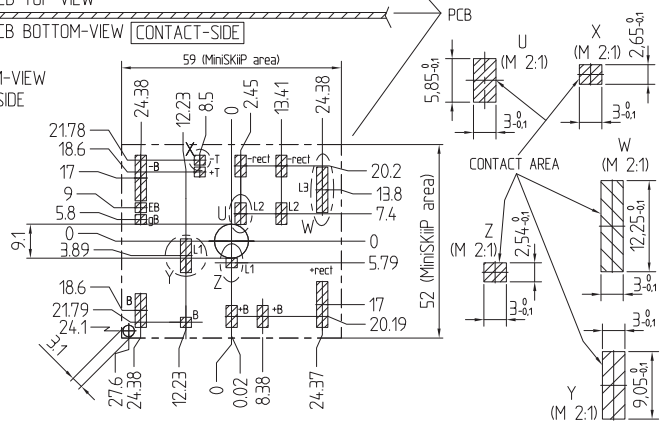

For mounting please follow the assembly instruction

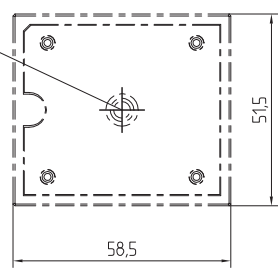

## pinout, dimensions

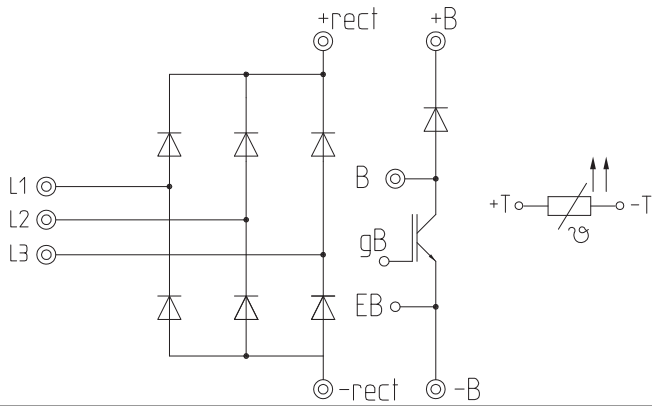

- ⊙ power connector
- control connector

## pinout

This is an electrostatic discharge sensitive device (ESDS), international standard IEC 60747-1, Chapter IX

\* The specifications of our components may not be considered as an assurance of component characteristics. Components have to be tested for the respective application. Adjustments may be necessary. The use of SEMIKRON products in life support appliances and systems is subject to prior specification and written approval by SEMIKRON. We therefore strongly recommend prior consultation of our staff.

## X-ON Electronics

Largest Supplier of Electrical and Electronic Components

*Click to view similar products for [IGBT Modules category](#):*

*Click to view products by [Semikron manufacturer](#):*

Other Similar products are found below :

[F3L100R07W2E3\\_B11](#) [F3L15R12W2H3\\_B27](#) [F3L400R07ME4\\_B22](#) [F3L400R12PT4\\_B26](#) [F4-100R12KS4](#) [F4-50R07W2H3\\_B51](#) [F4-75R12KS4\\_B11](#) [FB15R06W1E3](#) [FB20R06W1E3\\_B11](#) [FD1000R33HE3-K](#) [FD300R06KE3](#) [FD300R12KE3](#) [FD300R12KS4\\_B5](#) [FD400R12KE3](#) [FD400R33KF2C-K](#) [FD401R17KF6C\\_B2](#) [FD-DF80R12W1H3\\_B52](#) [FF100R12KS4](#) [FF1200R17KE3\\_B2](#) [FF150R12KE3G](#) [FF200R06KE3](#) [FF200R06YE3](#) [FF200R12KT3](#) [FF200R12KT3\\_E](#) [FF200R12KT4](#) [FF200R17KE3](#) [FF300R06KE3\\_B2](#) [FF300R12KE4\\_E](#) [FF300R12KS4HOSA1](#) [FF300R12ME4\\_B11](#) [FF300R12MS4](#) [FF300R17ME4](#) [FF450R12ME4P](#) [FF450R17IE4](#) [FF600R12IE4V](#) [FF600R12IP4V](#) [FF800R17KP4\\_B2](#) [FF900R12IE4V](#) [MIXA30W1200TED](#) [MIXA450PF1200TSF](#) [FP06R12W1T4\\_B3](#) [FP100R07N3E4](#) [FP100R07N3E4\\_B11](#) [FP10R06W1E3\\_B11](#) [FP10R12W1T4\\_B11](#) [FP10R12YT3](#) [FP10R12YT3\\_B4](#) [FP150R07N3E4](#) [FP15R12KT3](#) [FP15R12W2T4](#)