

SKiIP 29TMLI12F4V1

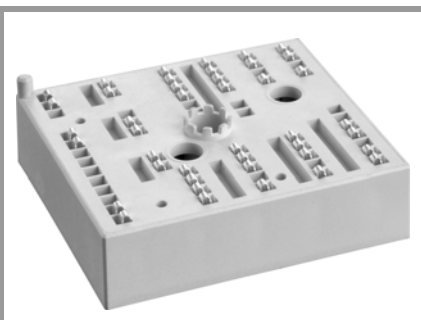

MiniSKiIP® 2

3-Level TNPC IGBT-Module

SKiIP 29TMLI12F4V1

Features*

- Fast Trench 4 IGBTs
- Trench IGBTs
- Robust and soft diodes in CAL technology
- Highly reliable spring contacts for electrical connections
- UL recognised: File no. E63532

Remarks*

- Case temperature limited to $T_C=125^\circ\text{C}$ max.; $T_C = T_S$ (for baseplateless modules)
- Product reliability results valid for $T_j \leq 150^\circ\text{C}$ (recommended $T_{jop} = -40 \dots +150^\circ\text{C}$)
- IGBT 1: outer IGBTs T1&T4
- IGBT 2: inner IGBTs T2&T3
- Diode 1: outer diodes D1&D4
- Diode 2: inner diodes D2&D3

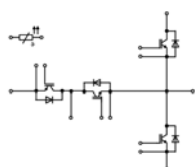

TMLI

Absolute Maximum Ratings				
Symbol	Conditions		Values	Unit
IGBT1				
V_{CES}	$T_j = 25^\circ\text{C}$		1200	V
I_C	$\lambda_{paste}=0.8 \text{ W/(mK)}$	$T_s = 25^\circ\text{C}$	144	A
		$T_j = 175^\circ\text{C}$	115	A
I_C	$\lambda_{paste}=2.5 \text{ W/(mK)}$	$T_s = 25^\circ\text{C}$	172	A
		$T_j = 175^\circ\text{C}$	138	A
I_{Cnom}			150	A
I_{CRM}	$I_{CRM} = 3 \times I_{Cnom}$		450	A
V_{GES}			-20 ... 20	V
t_{psc}	$V_{CC} = 800 \text{ V}, V_{GE} \leq 15 \text{ V}, T_j = 150^\circ\text{C}, V_{CES} \leq 1200 \text{ V}$		6	μs
T_j			-40 ... 175	$^\circ\text{C}$
IGBT2				
V_{CES}	$T_j = 25^\circ\text{C}$		650	V
I_C	$\lambda_{paste}=0.8 \text{ W/(mK)}$	$T_s = 25^\circ\text{C}$	131	A
		$T_j = 175^\circ\text{C}$	104	A
I_C	$\lambda_{paste}=2.5 \text{ W/(mK)}$	$T_s = 25^\circ\text{C}$	150	A
		$T_j = 175^\circ\text{C}$	120	A
I_{Cnom}			150	A
I_{CRM}	$I_{CRM} = 3 \times I_{Cnom}$		450	A
V_{GES}			-20 ... 20	V
t_{psc}	$V_{CC} = 360 \text{ V}, V_{GE} \leq 15 \text{ V}, T_j = 150^\circ\text{C}, V_{CES} \leq 650 \text{ V}$		6	μs
T_j			-40 ... 175	$^\circ\text{C}$
Diode1				
V_{RRM}	$T_j = 25^\circ\text{C}$		1200	V
I_F	$\lambda_{paste}=0.8 \text{ W/(mK)}$	$T_s = 25^\circ\text{C}$	148	A
		$T_j = 175^\circ\text{C}$	117	A
I_F	$\lambda_{paste}=2.5 \text{ W/(mK)}$	$T_s = 25^\circ\text{C}$	170	A
		$T_j = 175^\circ\text{C}$	136	A
I_{Fnom}			150	A
I_{FRM}	$I_{FRM} = 3 \times I_{Fnom}$		450	A
I_{FSM}	10 ms, sin 180°, $T_j = 25^\circ\text{C}$		774	A
T_j			-40 ... 175	$^\circ\text{C}$
Diode2				
V_{RRM}	$T_j = 25^\circ\text{C}$		650	V
I_F	$\lambda_{paste}=0.8 \text{ W/(mK)}$	$T_s = 25^\circ\text{C}$	129	A
		$T_j = 175^\circ\text{C}$	99	A
I_F	$\lambda_{paste}=2.5 \text{ W/(mK)}$	$T_s = 25^\circ\text{C}$	155	A
		$T_j = 175^\circ\text{C}$	121	A
I_{Fnom}			150	A
I_{FRM}	$I_{FRM} = 2 \times I_{Fnom}$		300	A
I_{FSM}	10 ms, sin 180°, $T_j = 25^\circ\text{C}$		1200	A
T_j			-40 ... 175	$^\circ\text{C}$
Module				
$I_t(\text{RMS})$			100	A
T_{stg}			-40 ... 125	$^\circ\text{C}$
V_{isol}	AC sinus 50 Hz, $t = 1 \text{ min}$		2500	V

SKiIP 29TMLI12F4V1

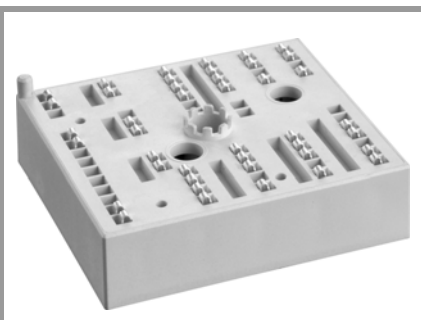

MiniSKiIP® 2

3-Level TNPC IGBT-Module

SKiIP 29TMLI12F4V1

Features*

- Fast Trench 4 IGBTs
- Trench IGBTs
- Robust and soft diodes in CAL technology
- Highly reliable spring contacts for electrical connections
- UL recognised: File no. E63532

Remarks*

- Case temperature limited to $T_C = 125^\circ\text{C}$ max.; $T_C = T_S$ (for baseplateless modules)
- Product reliability results valid for $T_j \leq 150^\circ\text{C}$ (recommended $T_{jop} = -40 \dots +150^\circ\text{C}$)
- IGBT 1: outer IGBTs T1&T4
- IGBT 2: inner IGBTs T2&T3
- Diode 1: outer diodes D1&D4
- Diode 2: inner diodes D2&D3

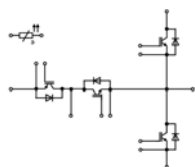

TMLI

Characteristics						
Symbol	Conditions		min.	typ.	max.	Unit
IGBT1						
$V_{CE(sat)}$	$I_C = 150\text{ A}$ $V_{GE} = 15\text{ V}$ chipllevel	$T_j = 25^\circ\text{C}$		2.05	2.42	V
		$T_j = 150^\circ\text{C}$		2.59	2.96	V
V_{CE0}	chipllevel	$T_j = 25^\circ\text{C}$		1.10	1.28	V
		$T_j = 150^\circ\text{C}$		0.95	1.13	V
r_{CE}	$V_{GE} = 15\text{ V}$ chipllevel	$T_j = 25^\circ\text{C}$		6.3	7.6	m Ω
		$T_j = 150^\circ\text{C}$		11	12	m Ω
$V_{GE(th)}$	$V_{GE} = V_{CE}, I_C = 5.2\text{ mA}$		5.2	5.8	6.4	V
I_{CES}	$V_{GE} = 0\text{ V}, V_{CE} = 1200\text{ V}, T_j = 25^\circ\text{C}$				0.3	mA
C_{ies}	$V_{CE} = 25\text{ V}$ $V_{GE} = 0\text{ V}$	$f = 1\text{ MHz}$		8.80		nF
C_{oes}		$f = 1\text{ MHz}$		0.58		nF
C_{res}		$f = 1\text{ MHz}$		0.47		nF
Q_G	$V_{GE} = -8\text{ V} \dots +15\text{ V}$			850		nC
R_{Gint}	$T_j = 25^\circ\text{C}$			5.0		Ω
$t_{d(on)}$	$V_{CE} = 300\text{ V}$	$T_j = 150^\circ\text{C}$		155		ns
t_r	$I_C = 150\text{ A}$	$T_j = 150^\circ\text{C}$		54		ns
E_{on}	$V_{GE} = +15/-15\text{ V}$	$T_j = 150^\circ\text{C}$		5.2		mJ
$t_{d(off)}$	$R_{G on} = 1.6\ \Omega$	$T_j = 150^\circ\text{C}$		323		ns
t_f	$R_{G off} = 1.6\ \Omega$	$T_j = 150^\circ\text{C}$		66		ns
E_{off}	$di/dt_{on} = 2550\text{ A}/\mu\text{s}$ $di/dt_{off} = 1850\text{ A}/\mu\text{s}$	$T_j = 150^\circ\text{C}$		6.1		mJ
$R_{th(j-s)}$	per IGBT, $\lambda_{paste} = 0.8\text{ W}/(\text{mK})$			0.35		K/W
$R_{th(j-s)}$	per IGBT, $\lambda_{paste} = 2.5\text{ W}/(\text{mK})$			0.26		K/W
IGBT2						
$V_{CE(sat)}$	$I_C = 150\text{ A}$ $V_{GE} = 15\text{ V}$ chipllevel	$T_j = 25^\circ\text{C}$		1.45	1.77	V
		$T_j = 150^\circ\text{C}$		1.70	2.10	V
V_{CE0}	chipllevel	$T_j = 25^\circ\text{C}$		0.90	1.00	V
		$T_j = 150^\circ\text{C}$		0.82	0.90	V
r_{CE}	$V_{GE} = 15\text{ V}$ chipllevel	$T_j = 25^\circ\text{C}$		3.7	5.1	m Ω
		$T_j = 150^\circ\text{C}$		5.9	8.0	m Ω
$V_{GE(th)}$	$V_{GE} = V_{CE}, I_C = 2.4\text{ mA}$		5.1	5.8	6.4	V
I_{CES}	$V_{GE} = 0\text{ V}, V_{CE} = 650\text{ V}, T_j = 25^\circ\text{C}$				0.3	mA
C_{ies}	$V_{CE} = 25\text{ V}$ $V_{GE} = 0\text{ V}$	$f = 1\text{ MHz}$		9.24		nF
C_{oes}		$f = 1\text{ MHz}$		0.60		nF
C_{res}		$f = 1\text{ MHz}$		0.27		nF
Q_G	$V_{GE} = -8\text{ V} \dots +15\text{ V}$			1360		nC
R_{Gint}	$T_j = 25^\circ\text{C}$			2.0		Ω
$t_{d(on)}$	$V_{CE} = 300\text{ V}$	$T_j = 150^\circ\text{C}$		118		ns
t_r	$I_C = 150\text{ A}$	$T_j = 150^\circ\text{C}$		40		ns
E_{on}	$V_{GE} = +15/-15\text{ V}$	$T_j = 150^\circ\text{C}$		1.6		mJ
$t_{d(off)}$	$R_{G on} = 1.6\ \Omega$	$T_j = 150^\circ\text{C}$		276		ns
t_f	$R_{G off} = 1.6\ \Omega$	$T_j = 150^\circ\text{C}$		79		ns
E_{off}	$di/dt_{on} = 3900\text{ A}/\mu\text{s}$ $di/dt_{off} = 1650\text{ A}/\mu\text{s}$	$T_j = 150^\circ\text{C}$		6.1		mJ
$R_{th(j-s)}$	per IGBT, $\lambda_{paste} = 0.8\text{ W}/(\text{mK})$			0.57		K/W
$R_{th(j-s)}$	per IGBT, $\lambda_{paste} = 2.5\text{ W}/(\text{mK})$			0.46		K/W

SKiIP 29TMLI12F4V1

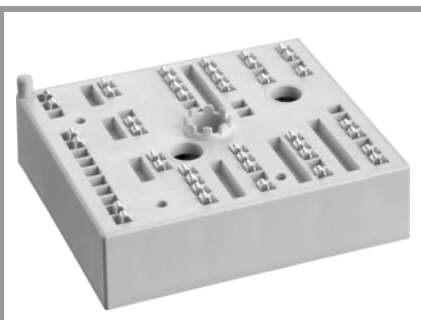

MiniSKiIP® 2

3-Level TNPC IGBT-Module

SKiIP 29TMLI12F4V1

Features*

- Fast Trench 4 IGBTs
- Trench IGBTs
- Robust and soft diodes in CAL technology
- Highly reliable spring contacts for electrical connections
- UL recognised: File no. E63532

Remarks*

- Case temperature limited to $T_C=125^\circ\text{C}$ max.; $T_C = T_S$ (for baseplateless modules)
- Product reliability results valid for $T_j \leq 150^\circ\text{C}$ (recommended $T_{jop} = -40 \dots +150^\circ\text{C}$)
- IGBT 1: outer IGBTs T1&T4
- IGBT 2: inner IGBTs T2&T3
- Diode 1: outer diodes D1&D4
- Diode 2: inner diodes D2&D3

Characteristics						
Symbol	Conditions		min.	typ.	max.	Unit
Diode1						
$V_F = V_{EC}$	$I_F = 150\text{ A}$ $V_{GE} = 0\text{ V}$ chipelevel	$T_j = 25^\circ\text{C}$		2.17	2.49	V
		$T_j = 150^\circ\text{C}$		2.11	2.42	V
V_{F0}	chipelevel	$T_j = 25^\circ\text{C}$		1.30	1.50	V
		$T_j = 150^\circ\text{C}$		0.90	1.10	V
r_F	chipelevel	$T_j = 25^\circ\text{C}$		5.8	6.6	m Ω
		$T_j = 150^\circ\text{C}$		8.1	8.8	m Ω
I_{RRM}	$I_F = 150\text{ A}$	$T_j = 150^\circ\text{C}$		191.3		A
Q_{rr}	$di/dt_{off} = 3760\text{ A}/\mu\text{s}$ $V_R = 300\text{ V}$	$T_j = 150^\circ\text{C}$		26		μC
E_{rr}	$V_{GE} = +15/-15\text{ V}$	$T_j = 150^\circ\text{C}$		6.5		mJ
$R_{th(j-s)}$	per Diode, $\lambda_{paste}=0.8\text{ W}/(\text{mK})$			0.45		K/W
$R_{th(j-s)}$	per Diode, $\lambda_{paste}=2.5\text{ W}/(\text{mK})$			0.36		K/W
Diode2						
$V_F = V_{EC}$	$I_F = 150\text{ A}$ $V_{GE} = 0\text{ V}$ chipelevel	$T_j = 25^\circ\text{C}$		1.40	1.76	V
		$T_j = 150^\circ\text{C}$		1.39	1.77	V
V_{F0}	chipelevel	$T_j = 25^\circ\text{C}$		1.04	1.24	V
		$T_j = 150^\circ\text{C}$		0.85	0.99	V
r_F	chipelevel	$T_j = 25^\circ\text{C}$		2.4	3.5	m Ω
		$T_j = 150^\circ\text{C}$		3.6	5.2	m Ω
I_{RRM}	$I_F = 150\text{ A}$	$T_j = 150^\circ\text{C}$		131.4		A
Q_{rr}	$di/dt_{off} = 2640\text{ A}/\mu\text{s}$ $V_R = 300\text{ V}$	$T_j = 150^\circ\text{C}$		13.5		μC
E_{rr}	$V_{GE} = +15/-15\text{ V}$	$T_j = 150^\circ\text{C}$		2.4		mJ
$R_{th(j-s)}$	per Diode, $\lambda_{paste}=0.8\text{ W}/(\text{mK})$			0.73		K/W
$R_{th(j-s)}$	per Diode, $\lambda_{paste}=2.5\text{ W}/(\text{mK})$			0.56		K/W
Module						
L_{sCE1}				-		nH
L_{CE}				-		nH
$R_{CC'+EE'}$			$T_s = 25^\circ\text{C}$	-		m Ω
			$T_s = 125^\circ\text{C}$	-		m Ω
M_s	to heat sink		2		2.5	Nm
M_t				-		Nm
						Nm
w				55		g
Temperature Sensor						
R_{100}	$T_r=100^\circ\text{C}$ ($R_{25}=1000\Omega$)			1670 \pm 3%		Ω
$R(T)$	$R(T)=1000\Omega[1+A(T-25^\circ\text{C})+B(T-25^\circ\text{C})^2]$ $A = 7.635 \cdot 10^{-3}\text{ }^\circ\text{C}^{-1}$, $B = 1.731 \cdot 10^{-5}\text{ }^\circ\text{C}^{-2}$					

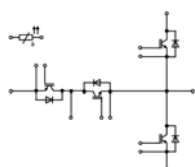

TMLI

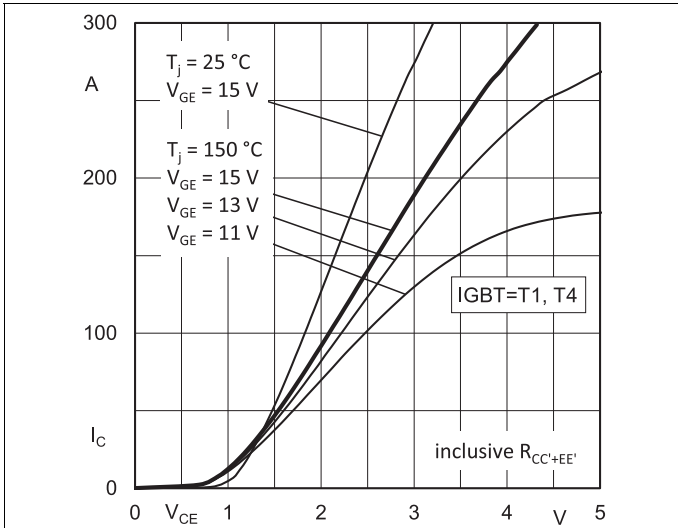

Fig. 1: Typ. IGBT1 output characteristic, incl. $R_{CC'+EE'}$

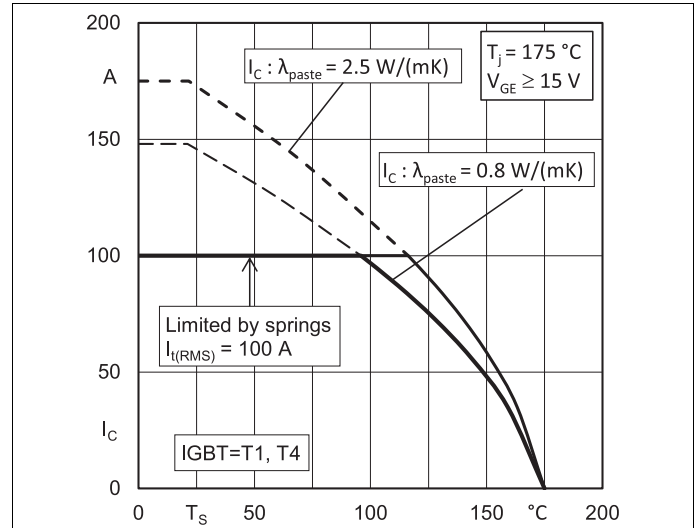

Fig. 2: IGBT1 rated current vs. Temperature $I_c=f(T_s)$

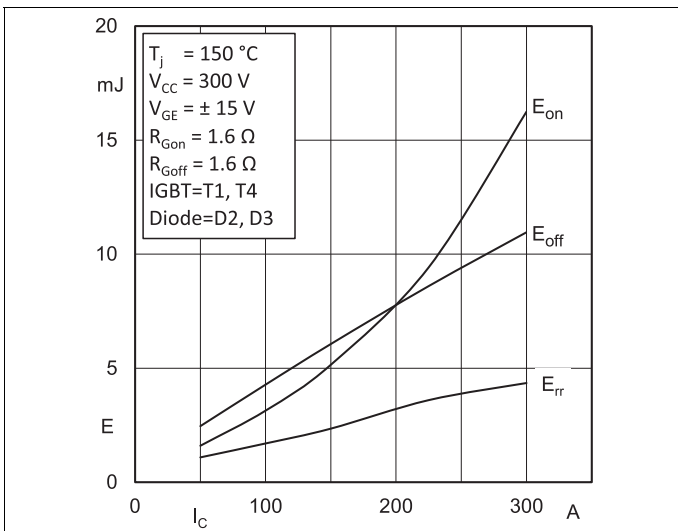

Fig. 3: Typ. IGBT1 & Diode2 turn-on /-off energy = $f(I_c)$

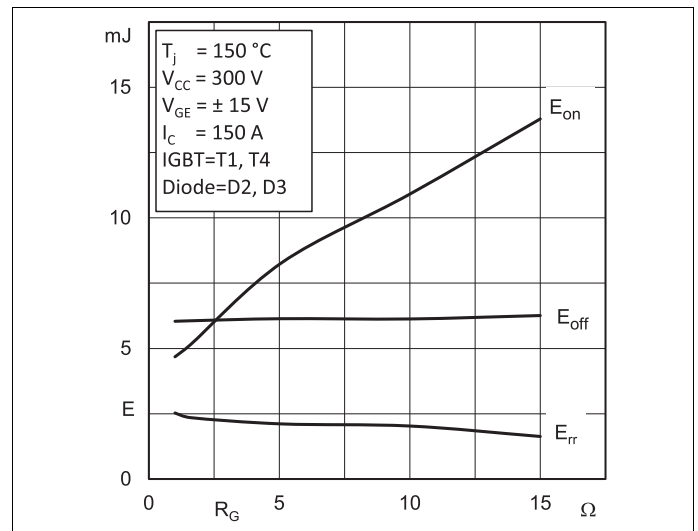

Fig. 4: Typ. IGBT1 & Diode2 turn-on /-off energy = $f(R_G)$

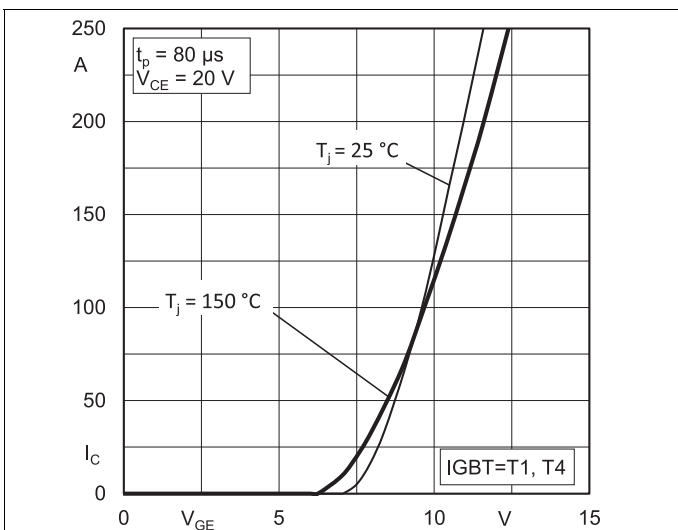

Fig. 5: Typ. IGBT1 transfer characteristic

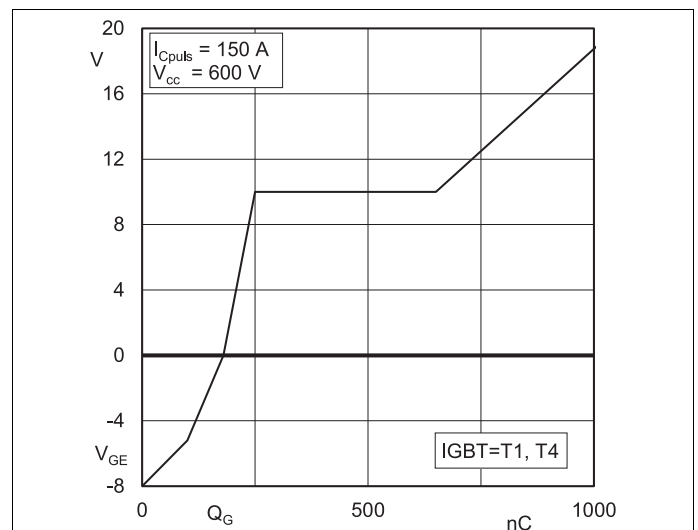
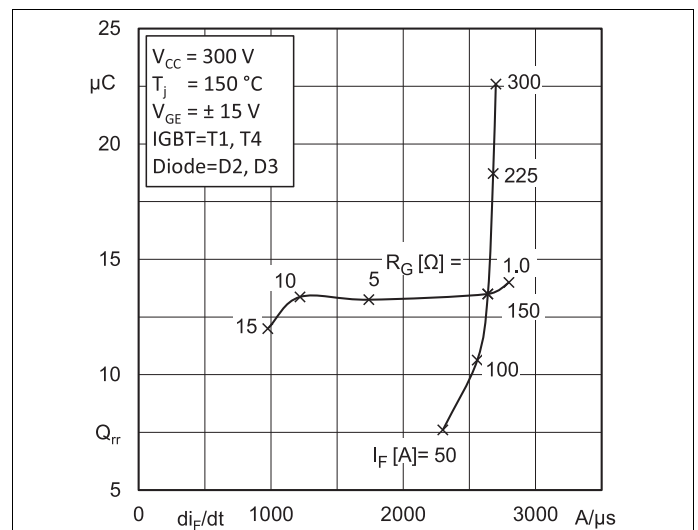
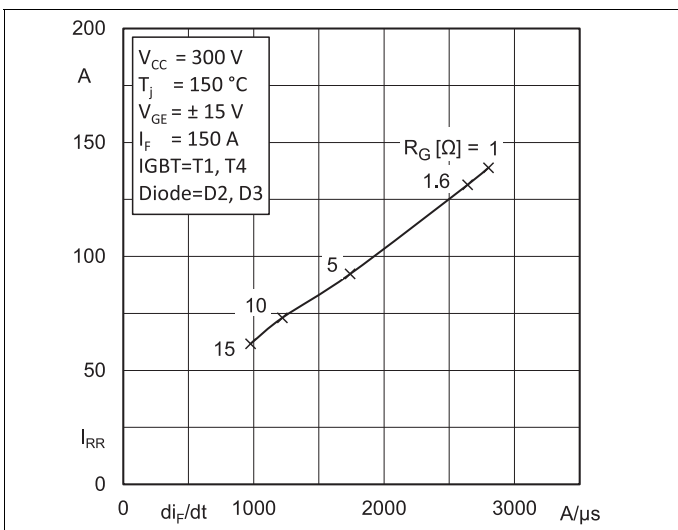
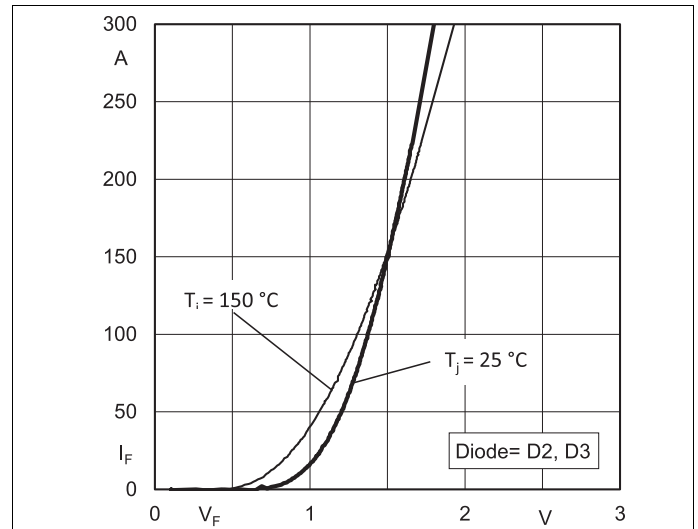
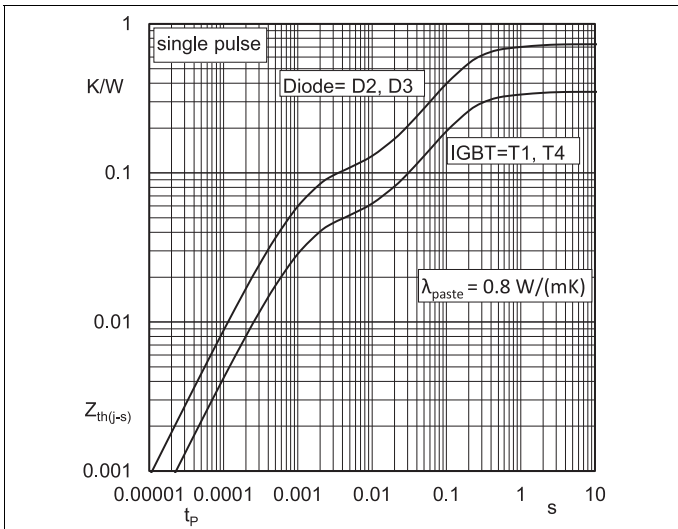
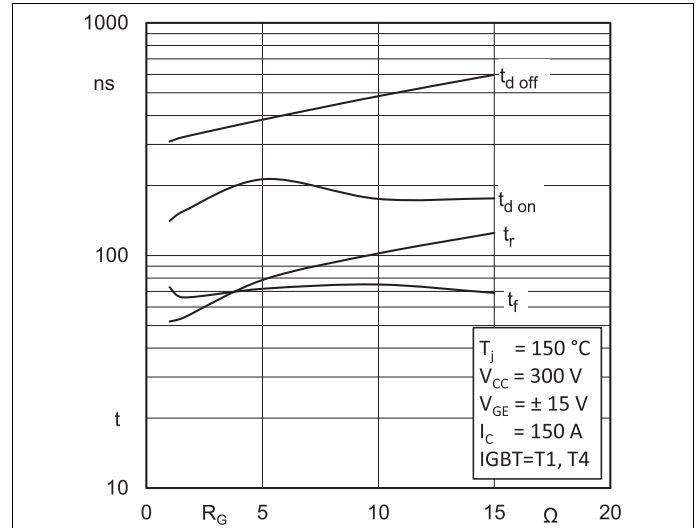
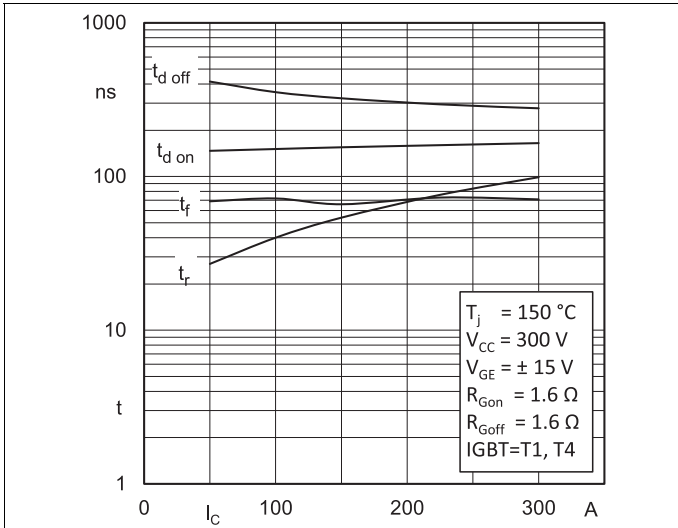
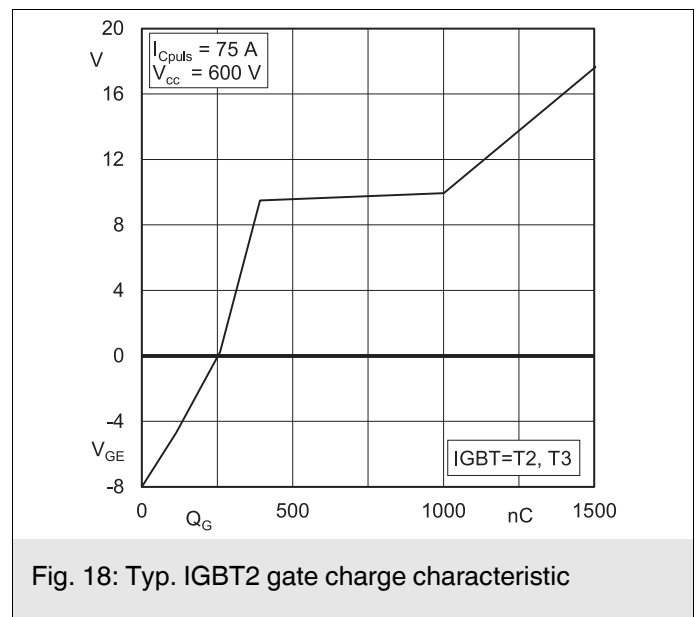
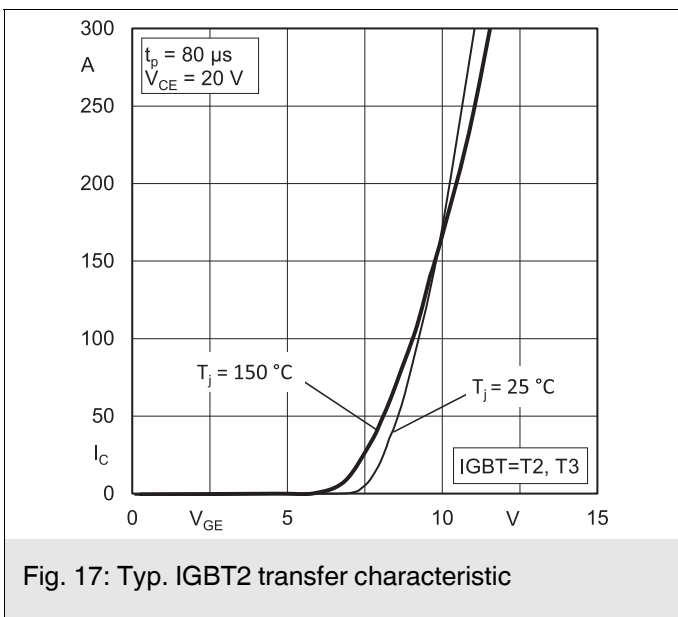
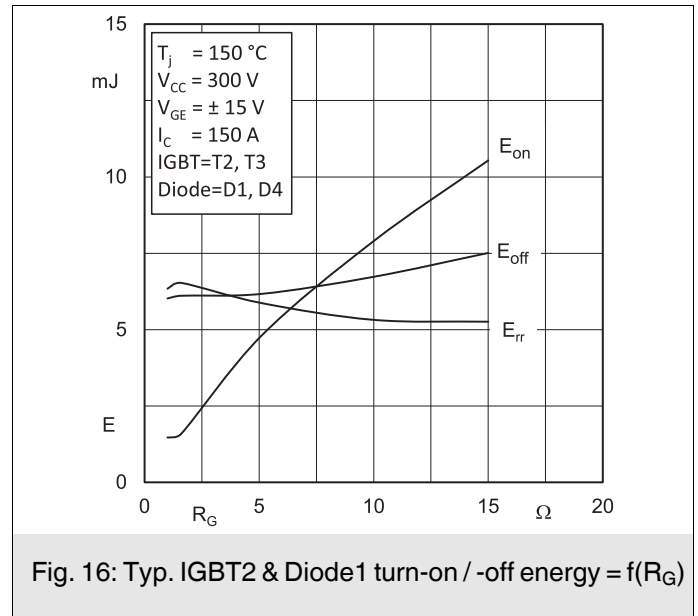
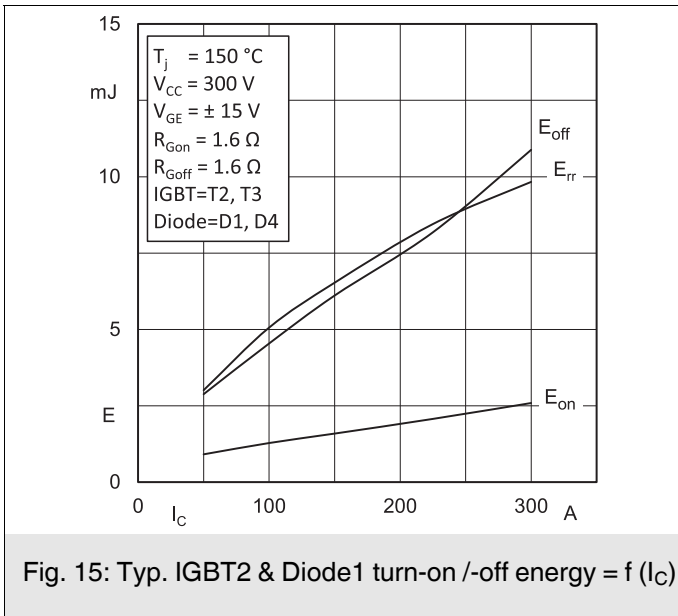
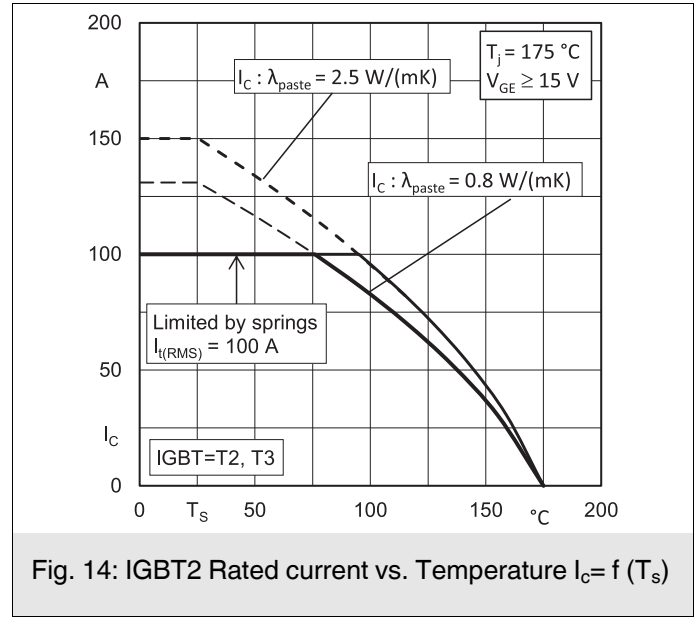
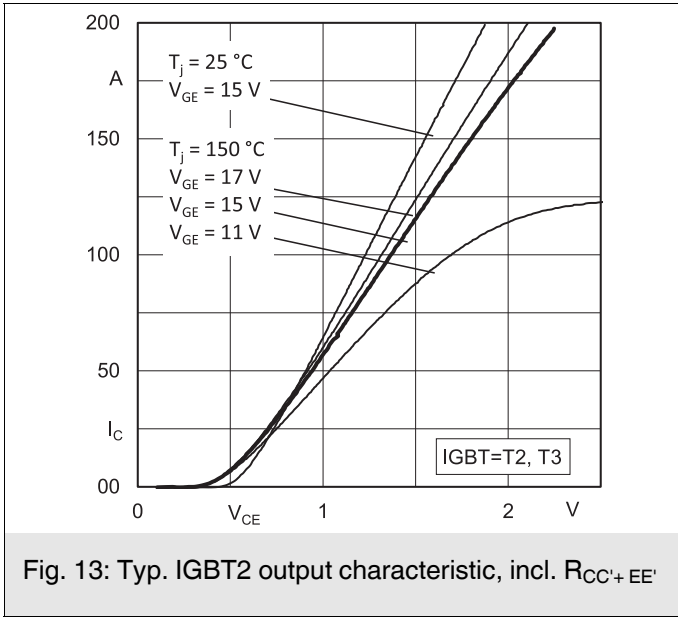

Fig. 6: Typ. IGBT1 gate charge characteristic





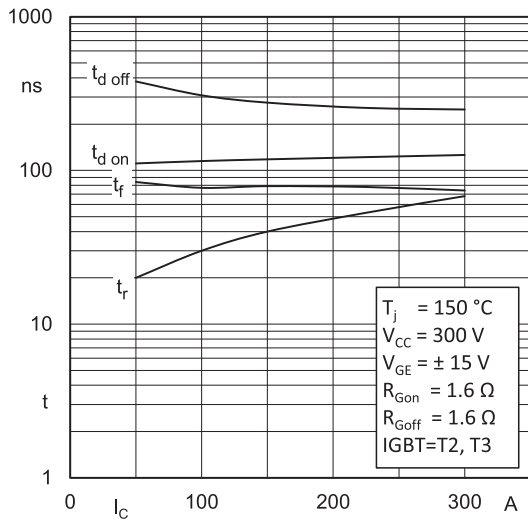

Fig. 19: Typ. IGBT2 switching times vs. I_C

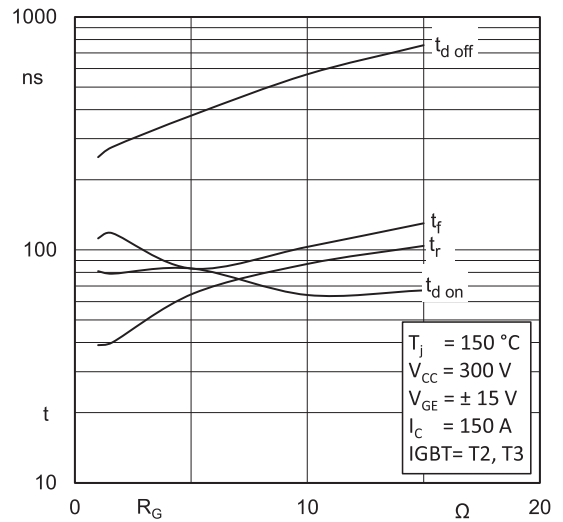

Fig. 20: Typ. IGBT2 switching times vs. gate resistor R_G

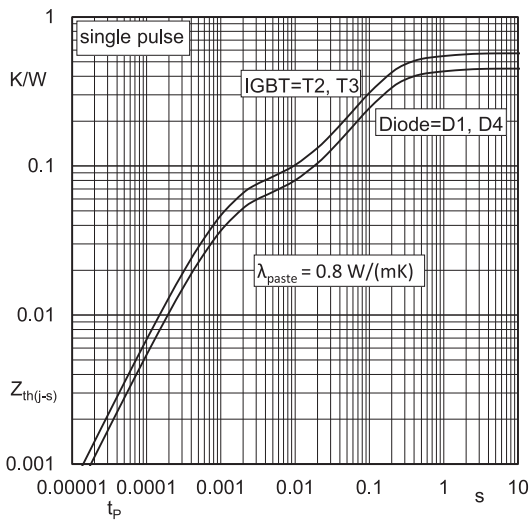

Fig. 21: Transient thermal impedance of IGBT2 & Diode1

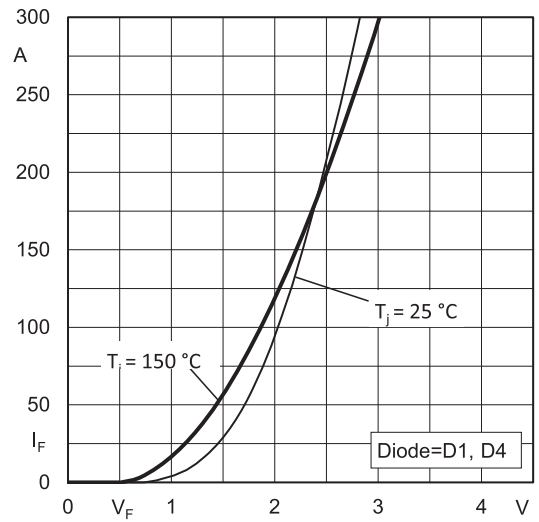

Fig. 22: Typ. Diode1 forward characteristic, incl. $R_{CC+EE'}$

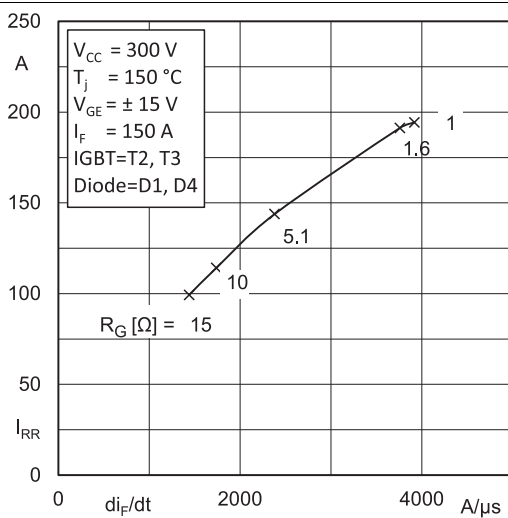

Fig. 23: Typ. Diode1 peak reverse recovery current

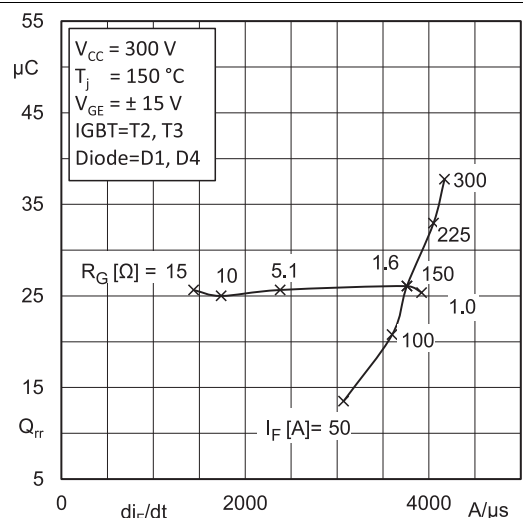
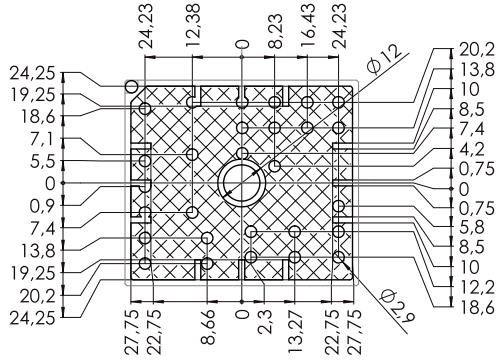

Fig. 24: Typ. Diode1 recovery charge

A

Mounting area for SMD, height max. 3,5
only valid for standard pressure part



standard pressure part
not part of MiniSKiIP, must
be ordered separately

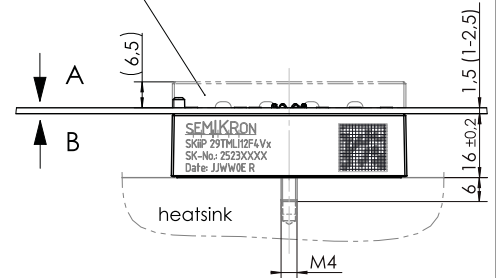

B

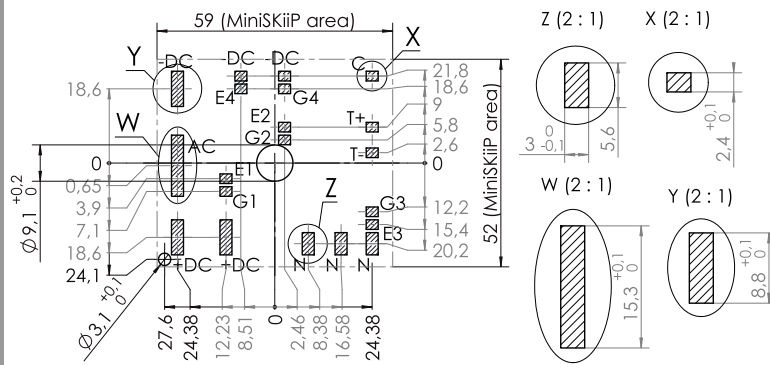

For mounting please follow
the assembly instruction

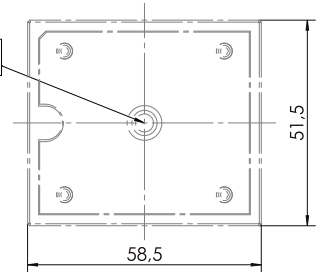

pinout, dimensions

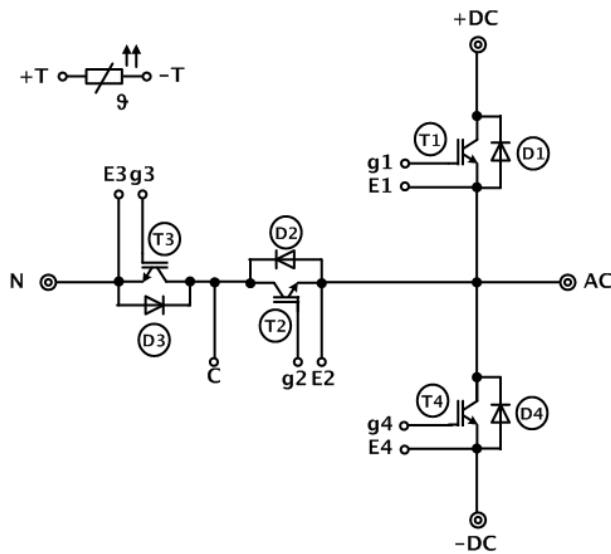

- ⊙ power connector
- control connector

pinout

This is an electrostatic discharge sensitive device (ESDS), international standard IEC 60747-1, chapter IX.

***IMPORTANT INFORMATION AND WARNINGS**

The specifications of SEMIKRON products may not be considered as guarantee or assurance of product characteristics ("Beschaffenheitsgarantie"). The specifications of SEMIKRON products describe only the usual characteristics of products to be expected in typical applications, which may still vary depending on the specific application. Therefore, products must be tested for the respective application in advance. Application adjustments may be necessary. The user of SEMIKRON products is responsible for the safety of their applications embedding SEMIKRON products and must take adequate safety measures to prevent the applications from causing a physical injury, fire or other problem if any of SEMIKRON products become faulty. The user is responsible to make sure that the application design is compliant with all applicable laws, regulations, norms and standards. Except as otherwise explicitly approved by SEMIKRON in a written document signed by authorized representatives of SEMIKRON, SEMIKRON products may not be used in any applications where a failure of the product or any consequences of the use thereof can reasonably be expected to result in personal injury. No representation or warranty is given and no liability is assumed with respect to the accuracy, completeness and/or use of any information herein, including without limitation, warranties of non-infringement of intellectual property rights of any third party. SEMIKRON does not assume any liability arising out of the applications or use of any product; neither does it convey any license under its patent rights, copyrights, trade secrets or other intellectual property rights, nor the rights of others. SEMIKRON makes no representation or warranty of non-infringement or alleged non-infringement of intellectual property rights of any third party which may arise from applications. Due to technical requirements our products may contain dangerous substances. For information on the types in question please contact the nearest SEMIKRON sales office. This document supersedes and replaces all information previously supplied and may be superseded by updates. SEMIKRON reserves the right to make changes.

X-ON Electronics

Largest Supplier of Electrical and Electronic Components

Click to view similar products for [IGBT Modules category](#):

Click to view products by [Semikron manufacturer](#):

Other Similar products are found below :

[F3L100R07W2E3_B11](#) [F3L15R12W2H3_B27](#) [F3L400R07ME4_B22](#) [F3L400R12PT4_B26](#) [F4-100R12KS4](#) [F4-50R07W2H3_B51](#) [F4-75R12KS4_B11](#) [FB15R06W1E3](#) [FB20R06W1E3_B11](#) [FD1000R33HE3-K](#) [FD300R06KE3](#) [FD300R12KE3](#) [FD300R12KS4_B5](#) [FD400R12KE3](#) [FD400R33KF2C-K](#) [FD401R17KF6C_B2](#) [FD-DF80R12W1H3_B52](#) [FF100R12KS4](#) [FF1200R17KE3_B2](#) [FF150R12KE3G](#) [FF200R06KE3](#) [FF200R06YE3](#) [FF200R12KT3](#) [FF200R12KT3_E](#) [FF200R12KT4](#) [FF200R17KE3](#) [FF300R06KE3_B2](#) [FF300R12KE4_E](#) [FF300R12KS4HOSA1](#) [FF300R12ME4_B11](#) [FF300R12MS4](#) [FF300R17ME4](#) [FF450R12ME4P](#) [FF450R17IE4](#) [FF600R12IE4V](#) [FF600R12IP4V](#) [FF800R17KP4_B2](#) [FF900R12IE4V](#) [MIXA30W1200TED](#) [MIXA450PF1200TSF](#) [FP06R12W1T4_B3](#) [FP100R07N3E4](#) [FP100R07N3E4_B11](#) [FP10R06W1E3_B11](#) [FP10R12W1T4_B11](#) [FP10R12YT3](#) [FP10R12YT3_B4](#) [FP150R07N3E4](#) [FP15R12KT3](#) [FP15R12W2T4](#)