

SKT 100

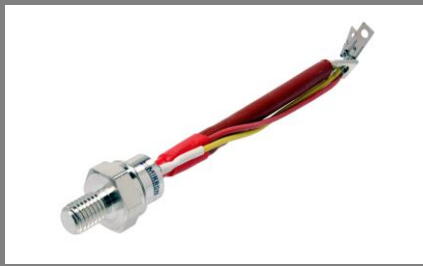

Stud Thyristor

V_{RSM} V	V_{RRM}, V_{DRM} V	$I_{TRMS} = 175$ A (maximum value for continuous operation) $I_{TAV} = 100$ A (sin. 180; $T_c = 85$ °C)
500	400	SKT 100/04 D
900	800	SKT 100/08 D
1300	1200	SKT 100/12 E
1500	1400	SKT 100/14 E
1700	1600	SKT 100/16 E
1900	1800	SKT 100/18 E

Line Thyristor

SKT 100

Features

- Hermetic metal case with glass insulator
- Threaded stud ISO M12 x 1,75 or ½" - 20 UNF 2A
- Interchangeable with international standard case

Typical Applications *

- DC motor control (e.g. for machine tools)
- Controlled rectifiers (e.g. for battery charging)
- AC controllers (e.g. for temperature control)
- Recommended snubber network e.g. for $V_{RMS} \leq 400$ V:
 $R = 47 \Omega / 10$ W, $C = 0,22 \mu F$

1) Mounting with grease-like thermal compound or joint contact compound
2) M12 x 1,75 is standard, "UNF" should be added in description for ½" - 20 2A thread.
e.g.: SKT 100/08 D UNF

Symbol	Condition	Values	Units
I_{TAV}	sin. 180; $T_c = 100$ (85) °C	74 (100)	A
I_D	2 x P1/120; $T_a = 50$ °C; B2/B6 2 x P1/120F; $T_a = 40$ °C; B2/B6	125 / 176 182 / 250	A A
I_{RMS}	2 x P1/120; $T_a = 45$ °C; W1C	146	A
I_{TSM}	$T_{vj} = 25$ °C ; 10 ms $T_{vj} = 130$ °C ; 10 ms	2000 1750	A A
i^2t	$T_{vj} = 25$ °C ; 8,3...10 ms $T_{vj} = 130$ °C ; 8,3...10 ms	20000 15300	A ² s A ² s
V_T	$T_{vj} = 25$ °C, $I_T = 300$ A	max. 1,75	V
$V_{T(TO)}$	$T_{vj} = 130$ °C	max. 1	V
r_T	$T_{vj} = 130$ °C	max. 2,4	mΩ
$I_{DD}; I_{RD}$	$T_{vj} = 130$ °C; $V_{RD} = V_{RRM}; V_{DD} = V_{DRM}$	max. 30	mA
t_{gd}	$T_{vj} = 25$ °C; $I_G = 1$ A; $di_G/dt = 1$ A/μs	1	μs
t_{gr}	$V_D = 0,67 * V_{DRM}$	2	μs
$(di/dt)_{cr}$	$T_{vj} = 130$ °C	max. 50	A/μs
$(dv/dt)_{cr}$	$T_{vj} = 130$ °C; D (E)	500 (1000)	V/μs
t_q	$T_{vj} = 130$ °C	100	μs
I_H	$T_{vj} = 25$ °C; typ. / max	150 / 250	mA
I_L	$T_{vj} = 25$ °C; typ. / max	300 / 600	mA
V_{GT}	$T_{vj} = 25$ °C; d.c.	min. 3	V
I_{GT}	$T_{vj} = 25$ °C; d.c.	min. 150	mA
V_{GD}	$T_{vj} = 130$ °C; d.c.	max. 0,25	V
I_{GD}	$T_{vj} = 130$ °C; d.c.	max. 10	mA
$R_{th(j-c)}$	cont.	0,25	K/W
$R_{th(j-c)}$	sin. 180	0,28	K/W
$R_{th(j-c)}$	rec. 120	0,31	K/W
$R_{th(c-s)}$		0,08	K/W
T_{vj}		-40...+130	°C
T_{stg}		-55...+150	°C
V_{isol}		-	V~
M_s	M12 or ½" - 20 UNF M12 or ½" - 20 UNF (lubricated) ¹⁾	10 7,5	Nm Nm
a		5 * 9,81	m/s ²
m	approx.	100	g
Case		B5	

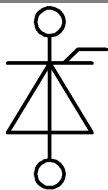

SKT

SKT 100

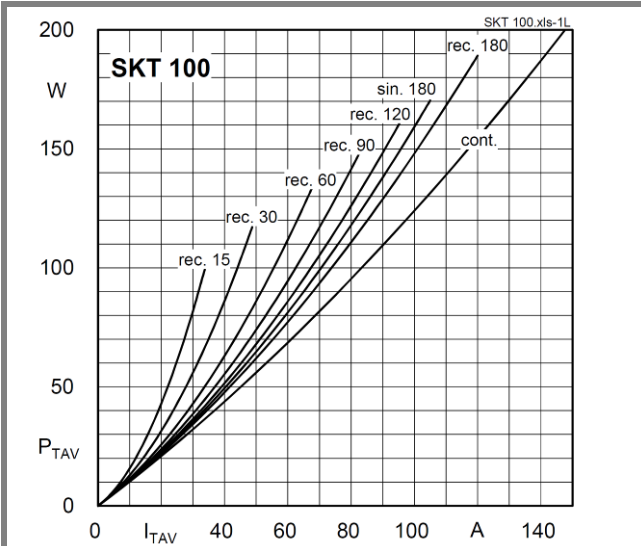

Fig. 1L Power dissipation vs. on-state current

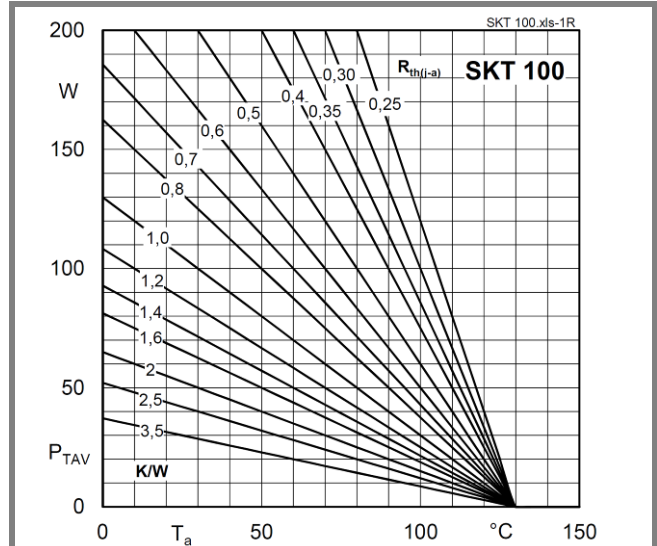

Fig. 1R Power dissipation vs. ambient temperature

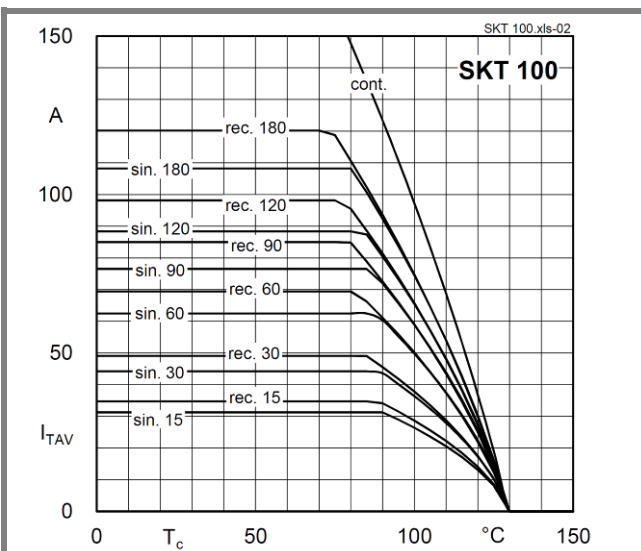

Fig. 2 Rated on-state current vs. case temperature

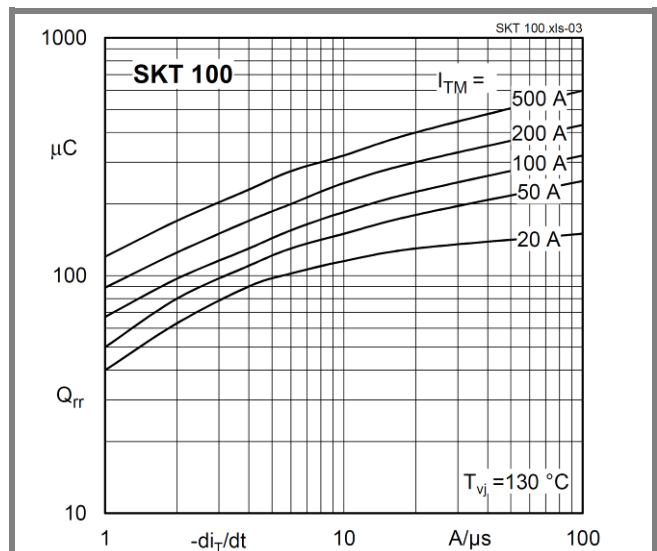

Fig. 3 Recovered charge vs. current decrease

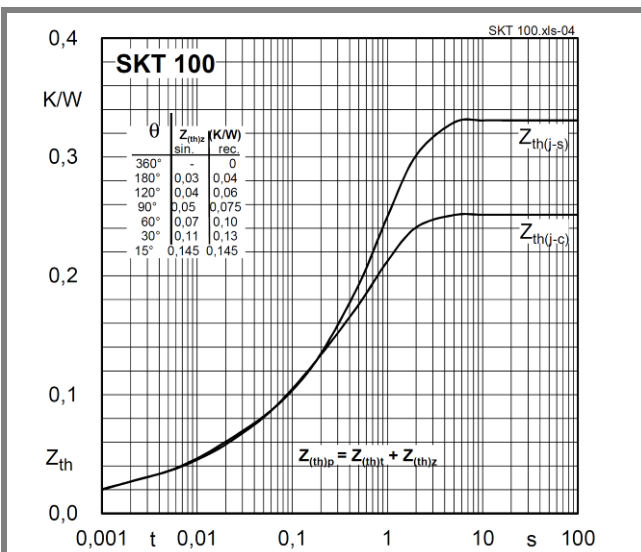

Fig. 4 Transient thermal impedance vs. time

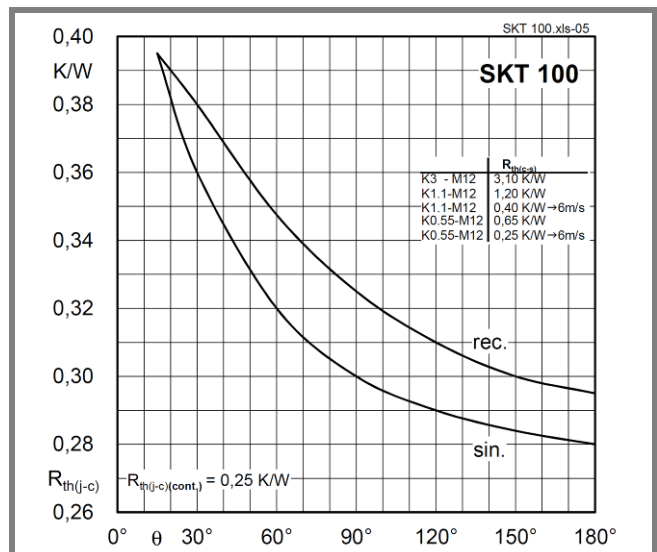

Fig. 5 Thermal resistance vs. conduction angle

SKT 100

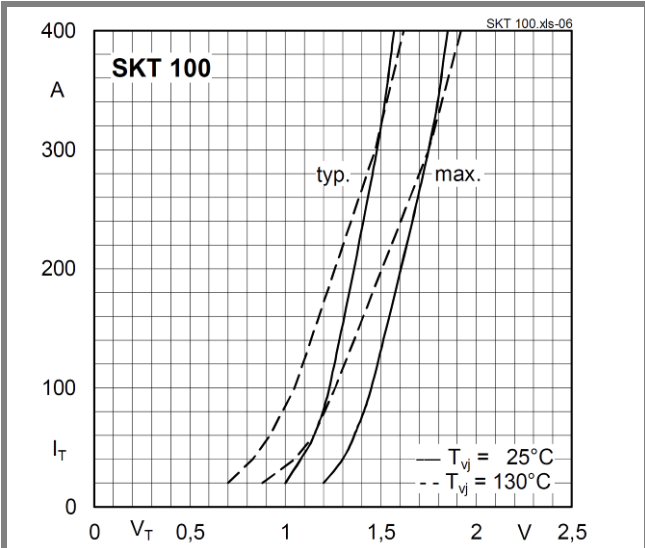

Fig. 6 On-state characteristics

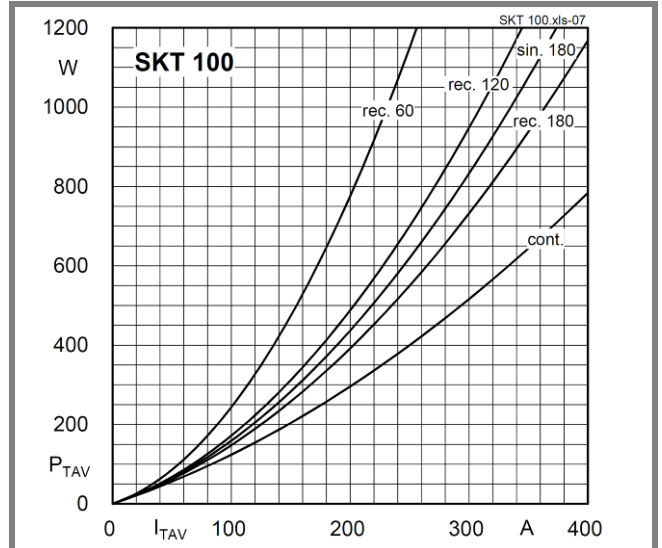

Fig. 7 Power dissipation vs. on-state current

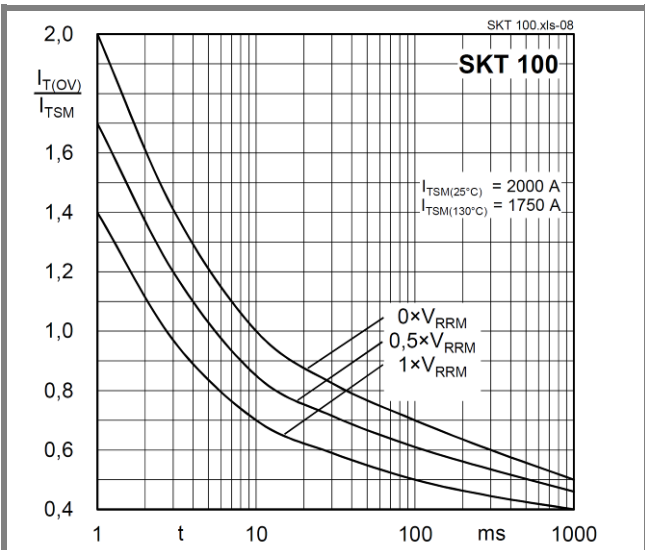
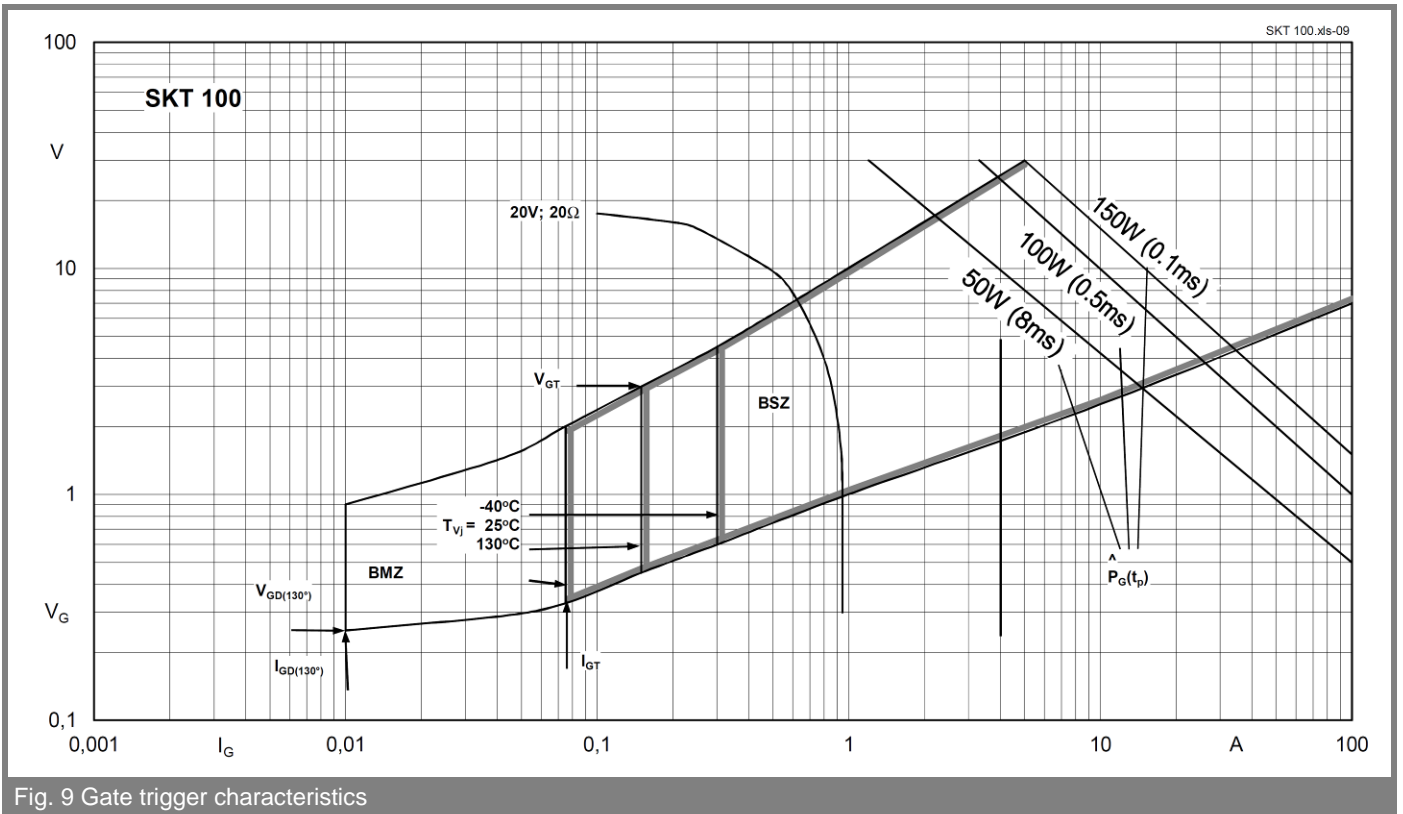
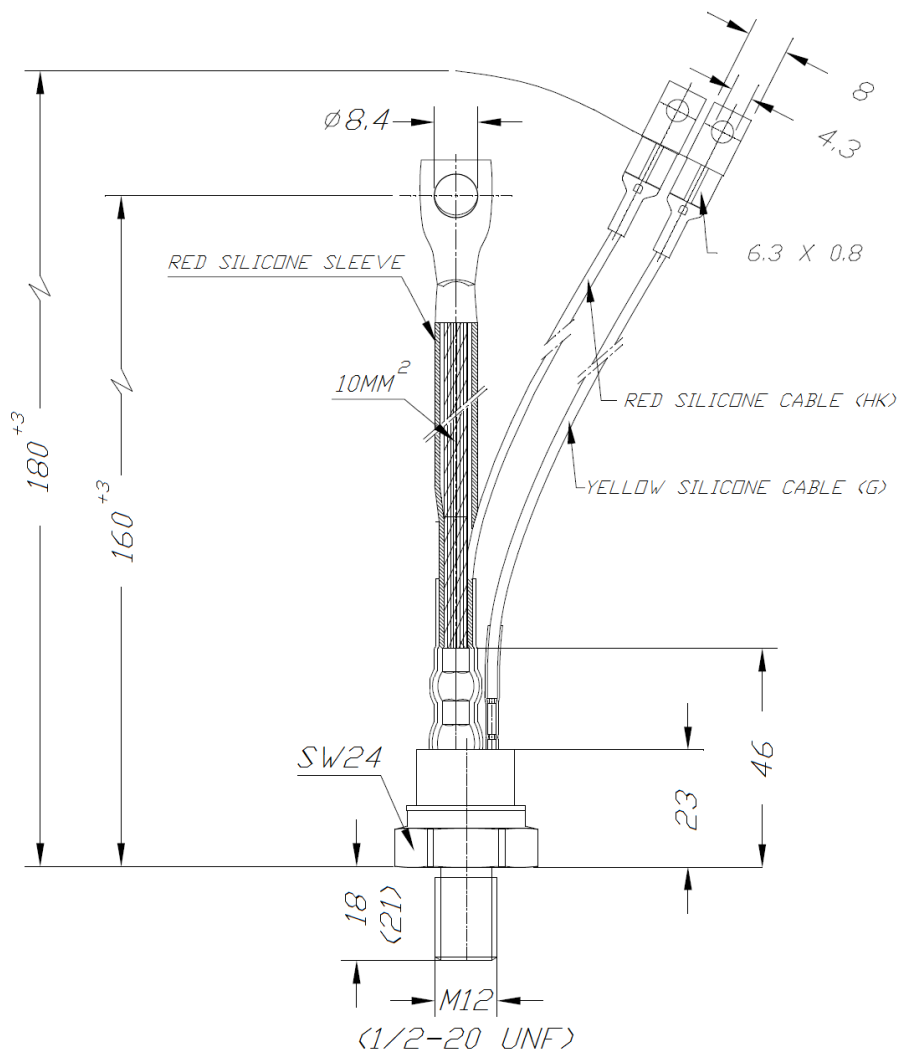

Fig. 8 Surge overload current vs. time





Case B5 (IEC 60191-2: A12MA, A12U; JEDEC: TO-209 (TO94))

***IMPORTANT INFORMATION AND WARNINGS**

The specifications of SEMIKRON products may not be considered as guarantee or assurance of product characteristics ("Beschaffenhheitsgarantie"). The specifications of SEMIKRON products describe only the usual characteristics of products to be expected in typical applications, which may still vary depending on the specific application. Therefore, products must be tested for the respective application in advance. Application adjustments may be necessary. The user of SEMIKRON products is responsible for the safety of their applications embedding SEMIKRON products and must take adequate safety measures to prevent the applications from causing a physical injury, fire or other problem if any of SEMIKRON products become faulty. The user is responsible to make sure that the application design is compliant with all applicable laws, regulations, norms and standards. Except as otherwise explicitly approved by SEMIKRON in a written document signed by authorized representatives of SEMIKRON, SEMIKRON products may not be used in any applications where a failure of the product or any consequences of the use thereof can reasonably be expected to result in personal injury. No representation or warranty is given and no liability is assumed with respect to the accuracy, completeness and/or use of any information herein, including without limitation, warranties of non-infringement of intellectual property rights of any third party. SEMIKRON does not assume any liability arising out of the applications or use of any product; neither does it convey any license under its patent rights, copyrights, trade secrets or other intellectual property rights, nor the rights of others. SEMIKRON makes no representation or warranty of non-infringement or alleged noninfringement of intellectual property rights of any third party which may arise from applications. Due to technical requirements our products may contain dangerous substances. For information on the types in question please contact the nearest SEMIKRON sales office. This document supersedes and replaces all information previously supplied and may be superseded by updates. SEMIKRON reserves the right to make changes.

X-ON Electronics

Largest Supplier of Electrical and Electronic Components

Click to view similar products for [Semikron](#) manufacturer:

Other Similar products are found below :

[SKKH106/08E](#) [SKM 400GAR125D](#) [SKR 130/14](#) [SKKH 92/12E](#) [SKM75GB17E4](#) [SKN 130/14](#) [SKT760/16E](#) [SKR240/04](#) [SKN71/16](#)
[SKM400GB12T4](#) [SKKH 27/16E](#) [SKKH 570/16 E](#) [SKN70/04](#) [SKKT 42/08E](#) [SK25WT16](#) [SKCH 40/08](#) [SKKD 701/18](#) [SKKE 600/20H4](#)
[SKKH 72/20E H4](#) [SKKQ 560/14E](#) [SKKT 570/12E](#) [SKKT 20/08E](#) [SKR 100/16](#) [SKT 10/08 D](#) [SKT 160/08 D](#) [SKDT 145/12](#) [SKKD 100/12](#)
[SKKT 42/18E](#) [SKR130/04](#) [SKKT 570/18E](#) [SKKT 57B14 E](#) [SKM 75GB176D](#) [SKPC100Z-440](#) [SKKH 72/08E](#) [P3/300B](#) [SKKD 260/16](#)
[SKKT 162/14 E](#) [SKB6008](#) [SKD 30/16A1](#) [SKBH 28/06](#) [SKCH 40/12](#) [SKKD 260/08](#) [SKM300GAR12E4](#) [SKD 210/16](#) [SKD 83/18](#) [SKHI](#)
[10/17 R](#) [SKKH 72/16E](#) [SKKT 132/22E H4](#) [SKN300/16](#) [DBI 25-04 P](#)