

SKT 130

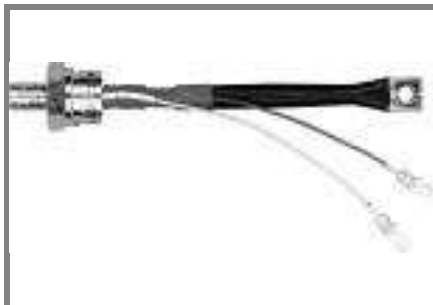

Stud Thyristor

Line Thyristor

SKT 130

Features

- Hermetic metal case with glass insulator
- Threaded stud ISO M16x1,5
- International standard case

Typical Applications*

- DC motor control (e. g. for machine tools)
- Controlled rectifiers (e. g. for battery charging)
- AC controllers (e. g. for temperature control)
- Recommended snubber network e. g. for $V_{VRMS} \leq 400$ V:
 $R = 33 \Omega / 13$ W, $C = 0,47 \mu F$

V_{RSM} V	V_{RRM}, V_{DRM} V	$I_{TRMS} = 220$ A (maximum value for continuous operation) $I_{TAV} = 130$ A (sin. 180; $T_c = 85$ °C)	
500	400	SKT 130/04D	
700	600	SKT 130/06D	
900	800	SKT 130/08D	
1300	1200	SKT 130/12E	
1500	1400	SKT 130/14E	
1700	1600	SKT 130/16E	

Symbol	Conditions	Values	Units
I_{TAV}	sin. 180; $T_c = 100$ (85) °C;	97 (130)	A
I_D	K1,1; $T_a = 45$ °C; B2 / B6	90 / 125	A
	K0,55; $T_a = 45$ °C; B2 / B6	140 / 200	A
I_{RMS}	K0,55; $T_a = 45$ °C; W1C	155	A
I_{TSM}	$T_{vj} = 25$ °C; 10 ms	3500	A
	$T_{vj} = 130$ °C; 10 ms	3000	A
i^2t	$T_{vj} = 25$ °C; 8,35 ... 10 ms	61000	A ² s
	$T_{vj} = 130$ °C; 8,35 ... 10 ms	45000	A ² s
V_T	$T_{vj} = 25$ °C; $I_T = 500$ A	max. 2,25	V
$V_{T(TO)}$	$T_{vj} = 130$ °C	max. 1,2	V
r_T	$T_{vj} = 130$ °C	max. 2,2	mΩ
I_{DD}, I_{RD}	$T_{vj} = 130$ °C; $V_{RD} = V_{RRM}; V_{DD} = V_{DRM}$	max. 50	mA
t_{gd}	$T_{vj} = 25$ °C; $I_G = 1$ A; $di_G/dt = 1$ A/μs	1	μs
t_{gr}	$V_D = 0,67 * V_{DRM}$	2	μs
$(di/dt)_{cr}$	$T_{vj} = 130$ °C	max. 100	A/μs
$(dv/dt)_{cr}$	$T_{vj} = 130$ °C; SKT ...D / SKT ...E	max. 500 / 1000	V/μs
t_q	$T_{vj} = 130$ °C,	120	μs
I_H	$T_{vj} = 25$ °C; typ. / max.	150 / 250	mA
I_L	$T_{vj} = 25$ °C; $R_G = 33 \Omega$; typ. / max.	300 / 600	mA
V_{GT}	$T_{vj} = 25$ °C; d.c.	min. 3	V
I_{GT}	$T_{vj} = 25$ °C; d.c.	min. 200	mA
V_{GD}	$T_{vj} = 130$ °C; d.c.	max. 0,25	V
I_{GD}	$T_{vj} = 130$ °C; d.c.	max. 10	mA
$R_{th(j-c)}$	cont.	0,16	K/W
$R_{th(j-c)}$	sin. 180	0,18	K/W
$R_{th(j-c)}$	rec. 120	0,2	K/W
$R_{th(c-s)}$		0,03	K/W
T_{vj}		- 40 ... + 130	°C
T_{stg}		- 55 ... + 150	°C
V_{isol}		-	V~
M_s	to heatsink	30	Nm
a		5 * 9,81	m/s ²
m	approx.	250	g
Case		B 6	

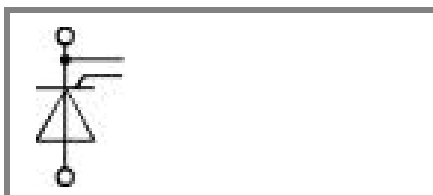

SKT

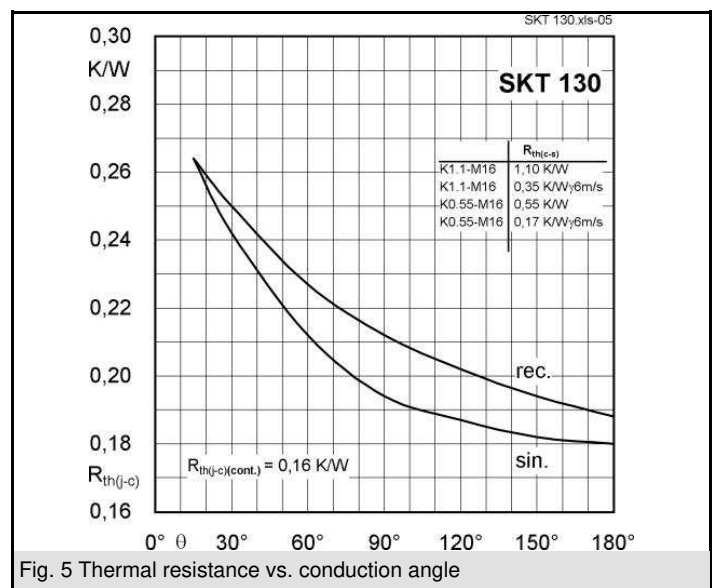
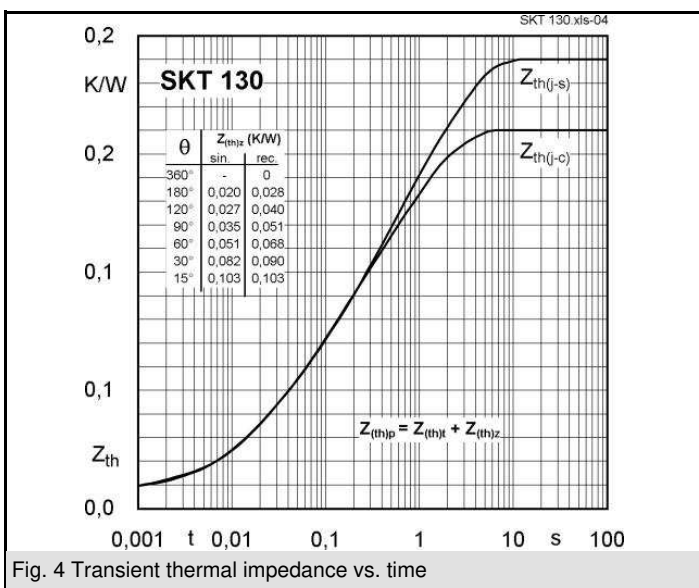
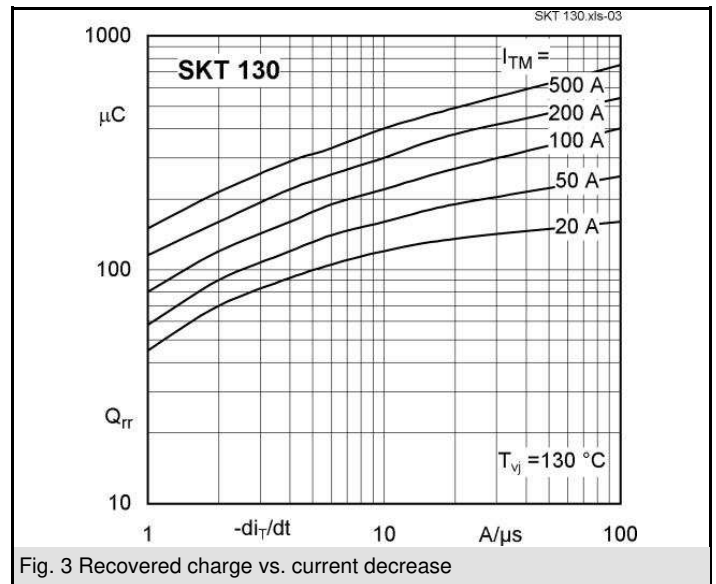
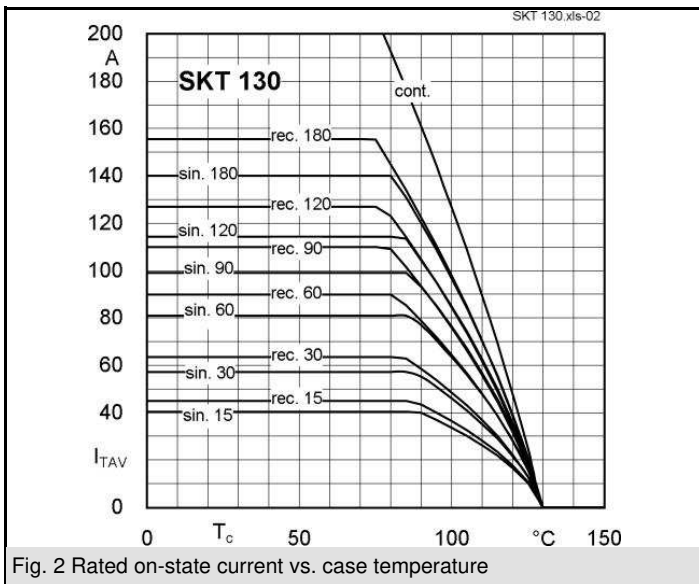
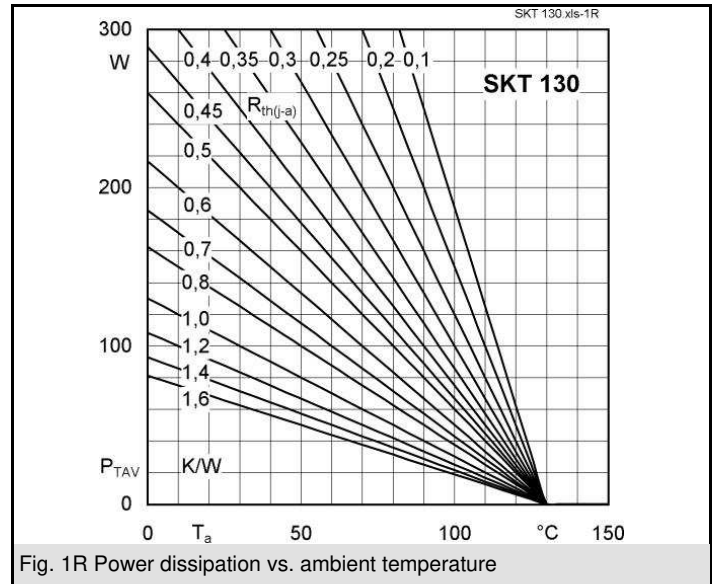
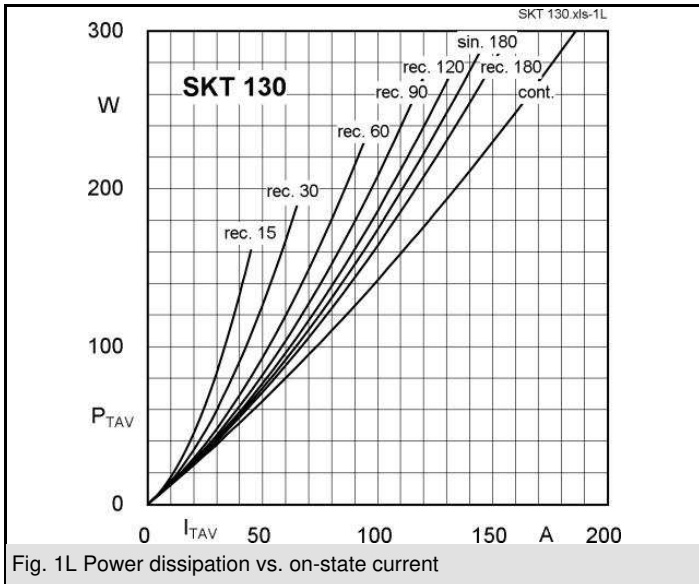

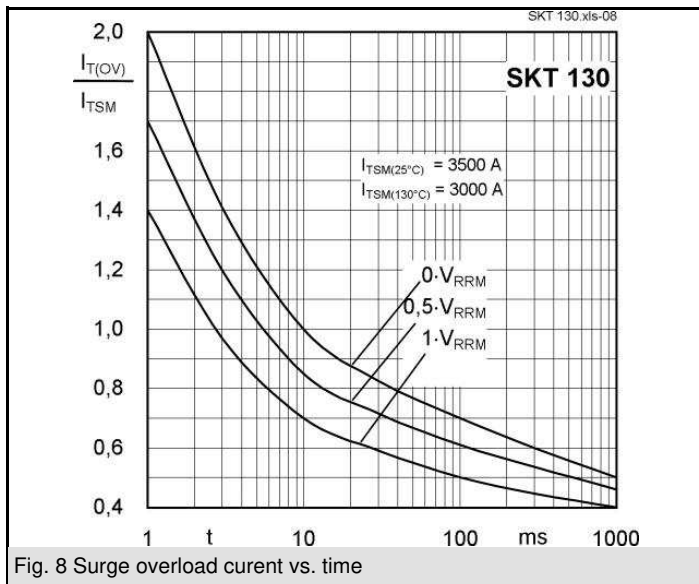
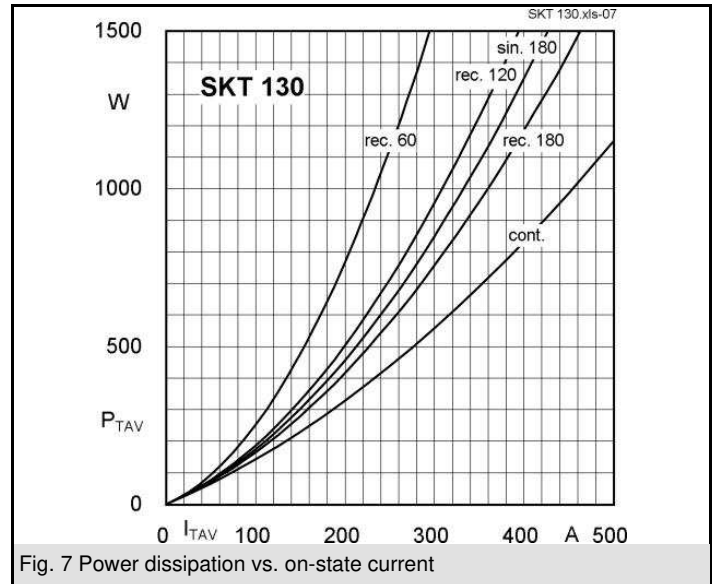
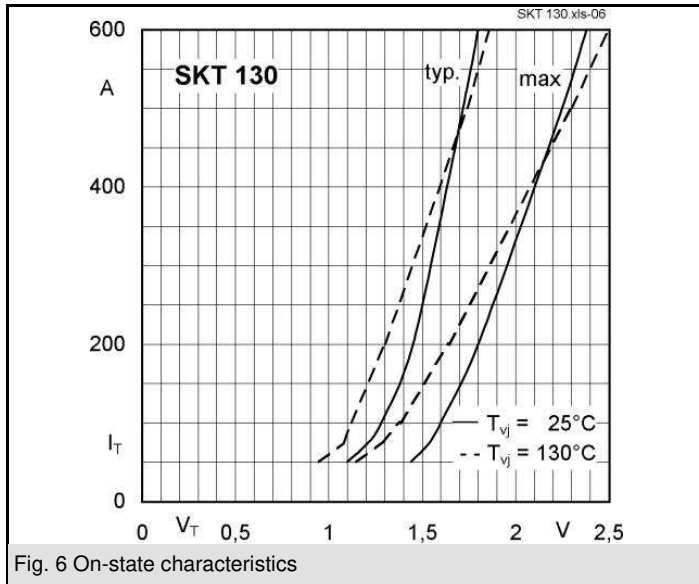

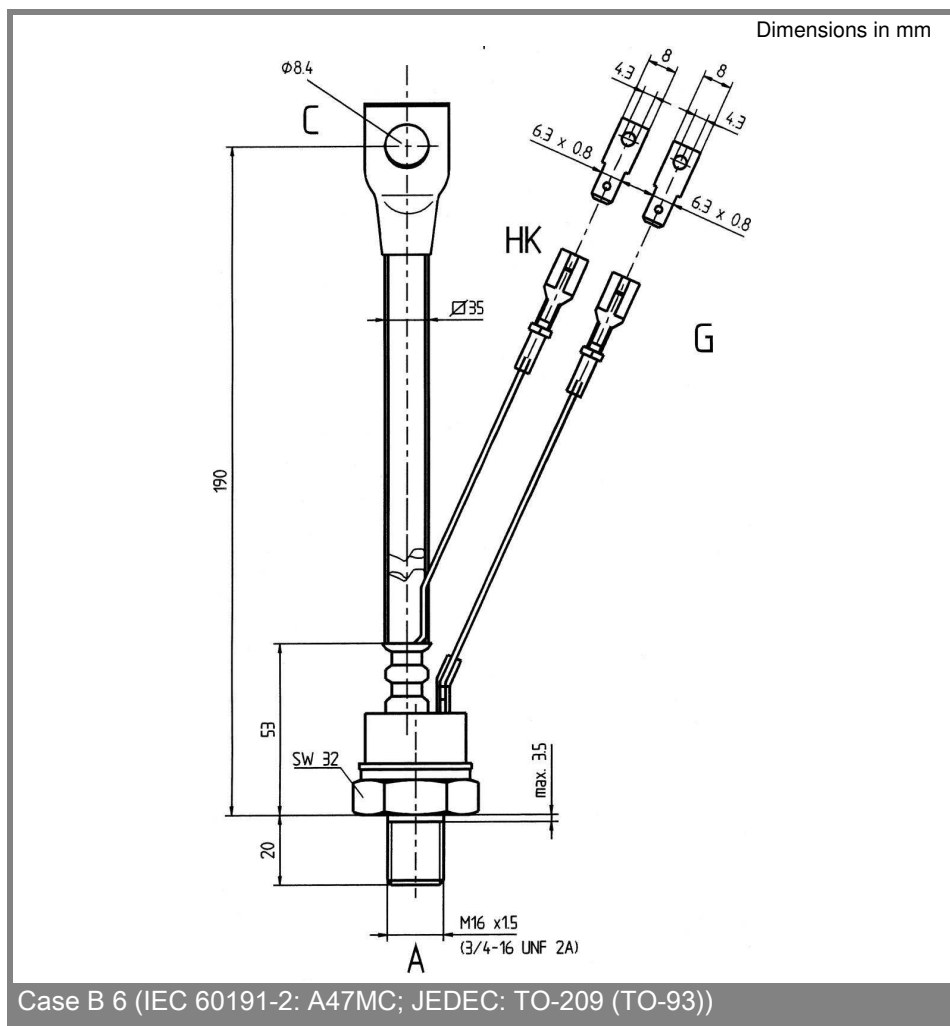
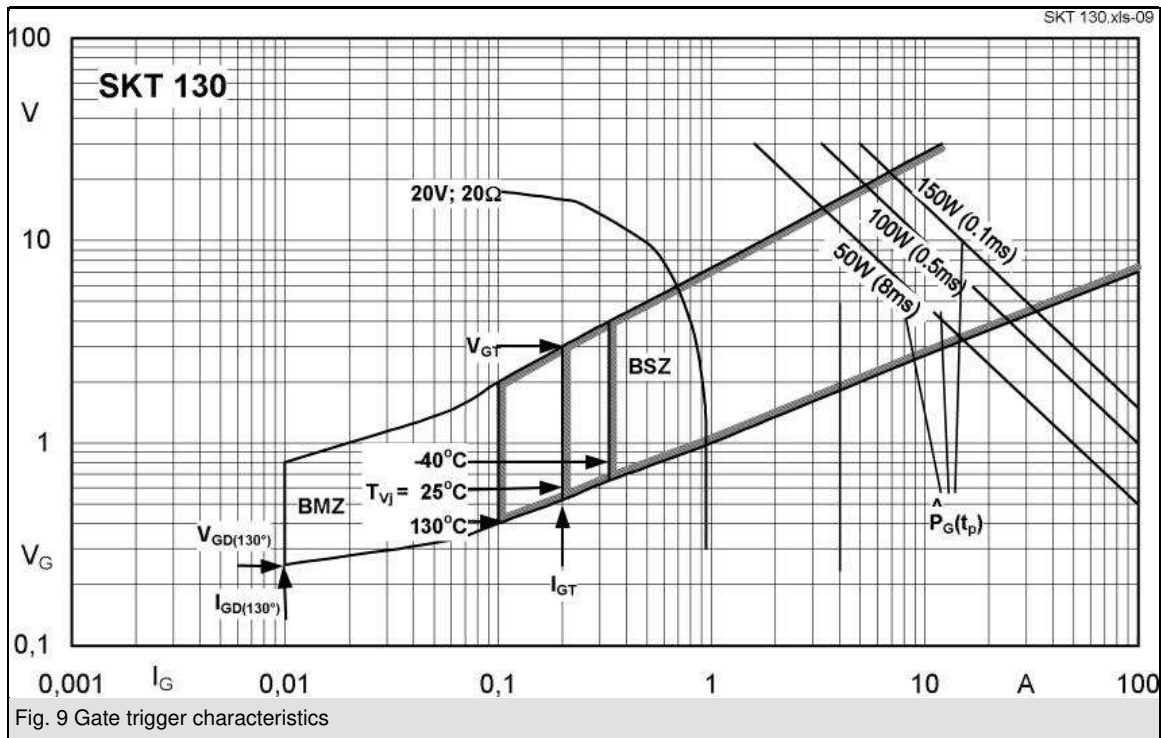

* The specifications of our components may not be considered as an assurance of component characteristics. Components have to be tested for the respective application. Adjustments may be necessary. The use of SEMIKRON

products in life support appliances and systems is subject to prior specification and written approval by SEMIKRON. We therefore strongly recommend prior consultation of our personal.

X-ON Electronics

Largest Supplier of Electrical and Electronic Components

Click to view similar products for [Semikron](#) manufacturer:

Other Similar products are found below :

[SKKH106/08E](#) [SKM 400GAR125D](#) [SKR 130/14](#) [SKKH 92/12E](#) [SKM75GB17E4](#) [SKN 130/14](#) [SKT760/16E](#) [SKR240/04](#) [SKN71/16](#)
[SKM400GB12T4](#) [SKKH 27/16E](#) [SKKH 570/16 E](#) [SKKT 42/08E](#) [SK25WT16](#) [SKCH 40/08](#) [SKKD 701/18](#) [SKKE 600/20H4](#) [SKKH 72/20E](#)
[H4](#) [SKKQ 560/14E](#) [SKKT 570/12E](#) [SKKT 20/08E](#) [SKR 100/16](#) [SKT 10/08 D](#) [SKT 160/08 D](#) [SKDT 145/12](#) [SKKD 100/12](#) [SKKT 42/18E](#)
[SKR130/04](#) [SKKT 570/18E](#) [SKKT 57B14 E](#) [SKM 75GB176D](#) [SKPC100Z-440](#) [SKKH 72/08E](#) [P3/300B](#) [SKKD 260/16](#) [SKKT 162/14 E](#)
[SKB6008](#) [SKD 30/16A1](#) [SKBH 28/06](#) [SKCH 40/12](#) [SKKD 260/08](#) [SKM300GAR12E4](#) [SKD 210/16](#) [SKD 83/18](#) [SKHI 10/17 R](#) [SKKH](#)
[72/16E](#) [SKKT 132/22E H4](#) [SKN300/16](#) [DBI 25-04 P](#) [SKN 100/12](#)