

---

## High Sensitive Digital-Latch Hall Effect Sensor with Internal Pull-up Resistor

---

### Features

- Built-in pull-up resistor
- High chopping frequency
- Supports a wide voltage range
  - 2.5 to 24V
  - Operation from unregulated supply
- Wide operating temperature range
- Factory-programmed at end-of-line for optimum
- Reverse battery protection
- Over-voltage protection at all pins
- Solid-state reliability
- Small package
  - 3-pin SIP
  - 3-pin SOT-23

### Output state

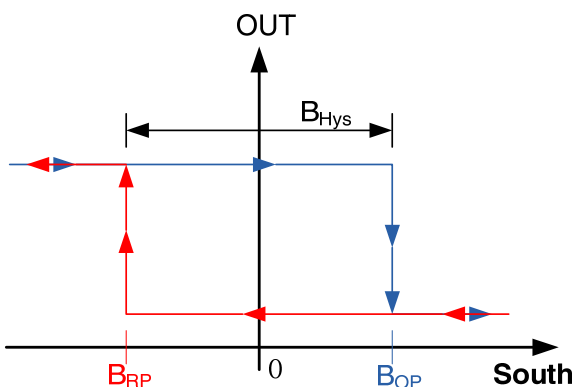

### Applications

- Power tools
- Flow meters
- Valve and solenoid status
- BLDC motors with sensors
- Proximity sensing
- Tachometers

### Description

The SC224X family, produced with BiCMOS technology, is a chopper-stabilized Hall Effect Sensor that offers a magnetic sensing solution with superior sensitivity stability over temperature and integrated protection features.

Superior high-temperature performance is made possible through dynamic offset cancellation, which reduces the residual offset voltage normally caused by device over molding, temperature dependencies, and thermal stress. Each device includes on a single silicon chip a voltage regulator, Hall-voltage generator, small-signal amplifier, chopper stabilization, Schmitt trigger, and an output circuit.

An onboard regulator permits with supply voltages of 2.5 to 24V which makes the device suitable for a wide range of industrial and automotive applications

The device is available in a 3-pin SIP package (UA) and a 3-pin SOT-23 style package (SO). Both are lead (Pb) free, with 100% matte tin leadframe plating.

## Device Information

Part Number	Packing	Mounting	Ambient, T <sub>A</sub>	B <sub>OP</sub> (Typ.)	B <sub>RP</sub> (Typ.)
SC2242UA	Bulk, 1000 pieces/bag	SIP3	-40°C to 150°C	+2.0mT	-2.0mT
SC2242SO	Reel, 3000pieces/reel	SOT-23			
SC2246UA	Bulk, 1000 pieces/bag	SIP3	-40°C to 150°C	+4.0mT	-4.0mT
SC2248UA	Bulk, 1000 pieces/bag	SIP3	-40°C to 150°C	+8.0mT	-8.0mT

## Terminal configuration and functions

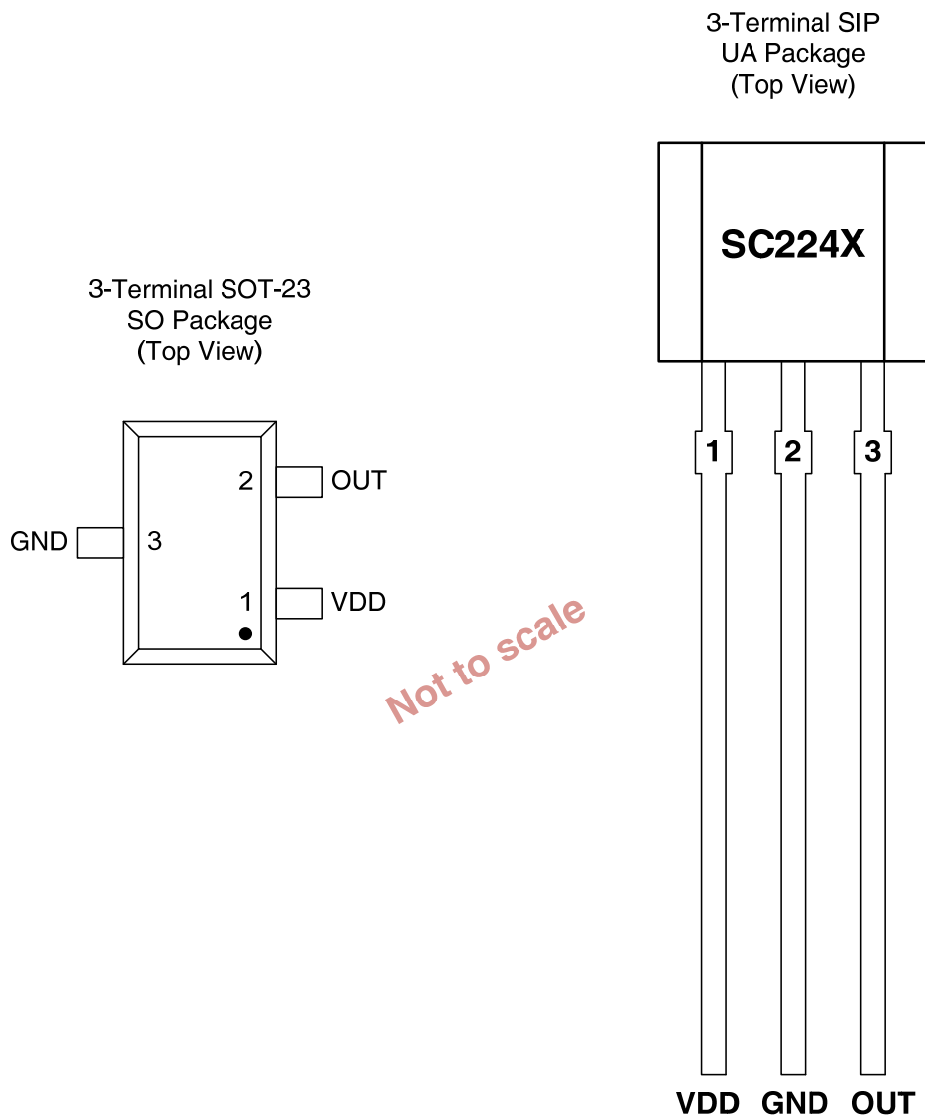

Terminal			Type	Description
Name	Number			
	UA	SO		
VDD	1	1	PWR	2.5 to 24 V power supply
GND	2	3	Ground	Ground terminal
OUT	3	2	Output	Internal pull-up resistor

## Absolute Maximum Ratings

over operating free-air temperature range (unless otherwise noted) <sup>(1)</sup>

Parameter	Symbol	Min.	Max.	Units
Power supply voltage	V <sub>DD</sub>	-28 <sup>(2)</sup>	28	V
Output terminal voltage	V <sub>OUT</sub>	-0.5	28	V
Output terminal current sink	I <sub>SINK</sub>	0	30	mA
Operating ambient temperature	T <sub>A</sub>	-40	150	°C
Maximum junction temperature	T <sub>J</sub>	-55	165	°C
Storage temperature	T <sub>STG</sub>	-65	175	°C

<sup>(1)</sup>Stresses above those listed here may cause permanent damage to the device. Exposure to absolute maximum rating conditions for extended periods may affect device reliability.

<sup>(2)</sup>Ensured by design.

## ESD Protection

Human Body Model (HBM) tests according to: standard AEC-Q100-002

Parameter	Symbol	Min.	Max.	Units
ESD-Protection	V <sub>ESD</sub>	-4	4	KV

## Thermal Characteristics

Symbol	Parameter	Test Conditions	Rating	Units
R <sub>θA</sub>	UA Package thermal resistance	Single-layer PCB, with copper limited to solder pads	166	°C/W
R <sub>θA</sub>	SO Package thermal resistance	Single-layer PCB, with copper limited to solder pads	228	°C/W

## Electrical Characteristics

over operating free-air temperature range ( $V_{DD} = 5.0V$ , unless otherwise noted)

Symbol	Parameter	Test Conditions	Min.	Typ.	Max.	Units
$V_{DD}$	Operating voltage <sup>(1)</sup>	$T_J < T_{J(Max.)}$	2.5	--	24	V
$V_{DDR}$	Reverse supply voltage	$I_{DD} < -10mA$ , $T_A=25^\circ C$	-10	--	--	V
$I_{DD}$	Operating supply current	$V_{DD}=2.5$ to 24 V, $T_A=25^\circ C$	1.2	1.6	2.0	mA
		$V_{DD}=2.5$ to 24 V, $T_A=125^\circ C$	1.3	1.7	2.1	mA
$t_{on}$	Power-on time		--	25	40	$\mu S$
$R_{UP}$	Internal pull-up resistor		5.0	10	15	$K\Omega$
$I_{QL}$	Off-state leakage current	Output Hi-Z	--	--	3	$\mu A$
$R_{DS(on)}$	FET on-resistance	$V_{DD}=5V$ , $I_O=10mA$ , $T_A=25^\circ C$	--	20	--	$\Omega$
		$V_{DD}=5V$ , $I_O=10mA$ , $T_A=125^\circ C$	--	30	--	$\Omega$
$t_d$	Output delay time	$B=B_{RP}$ to $B_{OP}$	--	15	25	$\mu S$
$t_r$	Output rise time (10% to 90%)	$R1=1Kohm$ $C_o=50pF$	--	0.2	0.5	$\mu S$
$t_f$	Output fall time (90% to 10%)	$R1=1Kohm$ $C_o=50pF$	--	0.1	0.2	$\mu S$

<sup>(1)</sup> Maximum voltage must be adjusted for power dissipation and junction temperature, see Thermal Characteristics

## Magnetic Characteristics

over operating free-air temperature range (unless otherwise noted)

Symbol	Parameter	Test Conditions	Min.	Typ.	Max.	Units
$f_{BW}$	Bandwidth		20	--	--	kHz
<b>SC2242 +2.0 / -2.0 mT</b>						
$B_{OP}$	Operated point	$T_A=25^\circ\text{C}$	+1.0	+2.0	+3.0	mT
$B_{RP}$	Release point		-3.0	-2.0	-1.0	mT
$B_{HYS}$	Hysteresis		3.0	4.0	5.0	mT
$B_O$	Magnetic offset	$B_O=(B_{OP}+B_{RP})/2$	-1.0	0	+1.0	mT
<b>SC2246 +4.0 / -4.0 mT</b>						
$B_{OP}$	Operated point	$T_A=25^\circ\text{C}$	+2.0	+4.0	+6.0	mT
$B_{RP}$	Release point		-6.0	-4.0	-2.0	mT
$B_{HYS}$	Hysteresis		6.0	8.0	10.0	mT
$B_O$	Magnetic offset	$B_O=(B_{OP}+B_{RP})/2$	-2.0	0	+2.0	mT
<b>SC2248 +8.0 / -8.0 mT</b>						
$B_{OP}$	Operated point	$T_A=25^\circ\text{C}$	+6.0	+8.0	+10.0	mT
$B_{RP}$	Release point		-10.0	-8.0	-6.0	mT
$B_{HYS}$	Hysteresis		14.0	16.0	18.0	mT
$B_O$	Magnetic offset	$B_O=(B_{OP}+B_{RP})/2$	-2.0	0	+2.0	mT

1mT=10Gs

Magnetic flux density,  $B$ , is indicated as a negative value for North-polarity magnetic fields, and as a positive value for South-polarity magnetic fields.

### Characteristic Data

**$I_{DD}$  VS  $V_{DD}$**

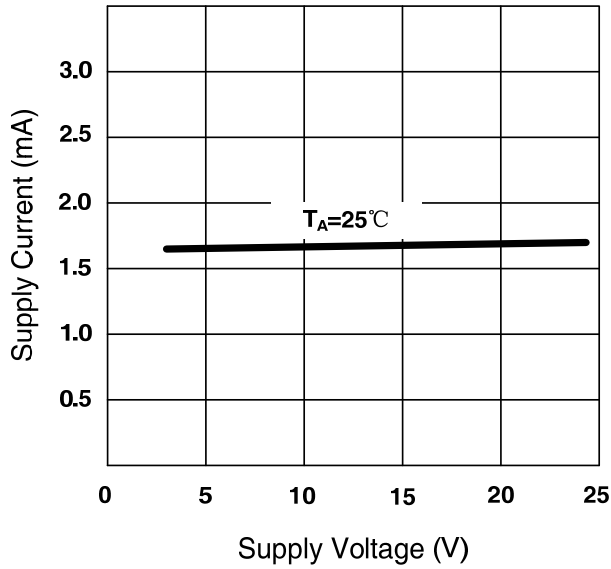

**$I_{DD}$  VS  $T_A$**

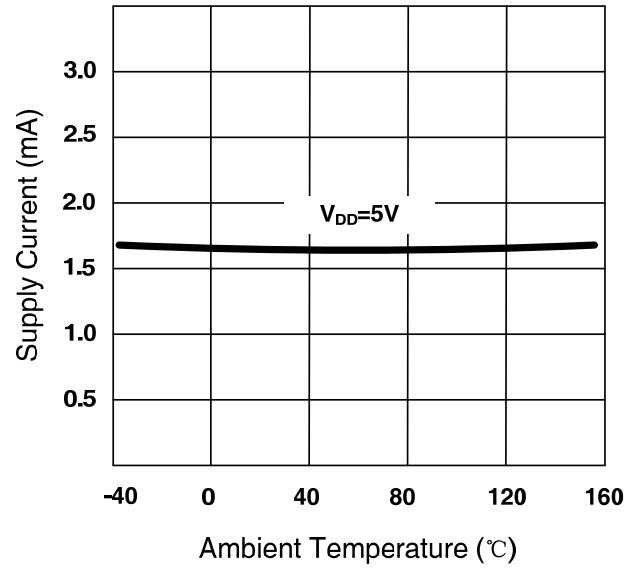

**$V_{Q(sat)}$  VS  $V_{DD}$**

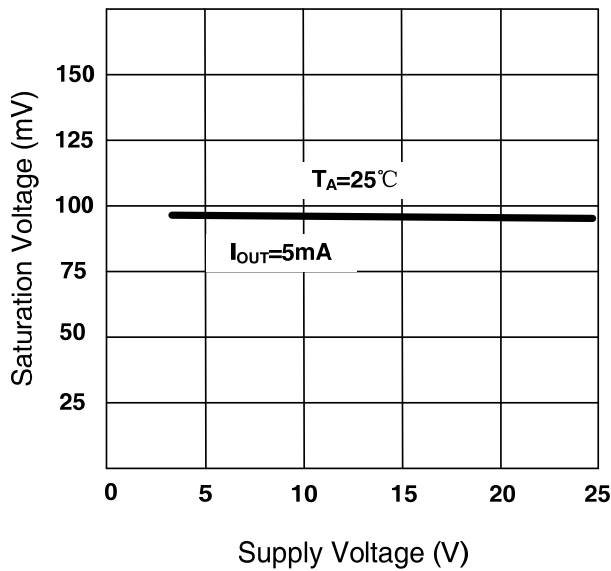

**$V_{Q(sat)}$  VS  $T_A$**

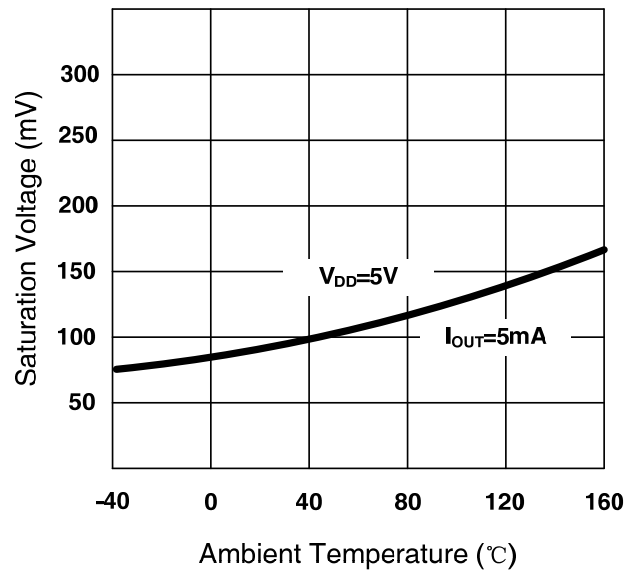

Characteristic Data (Continued)

**SC2242**  
**B<sub>OP</sub> and B<sub>RP</sub> vs T<sub>A</sub>**

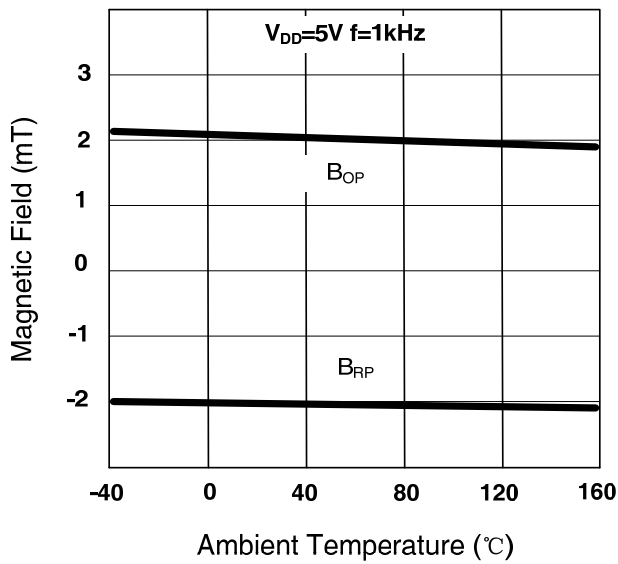

**SC2242**  
**B<sub>HYS</sub> vs T<sub>A</sub>**

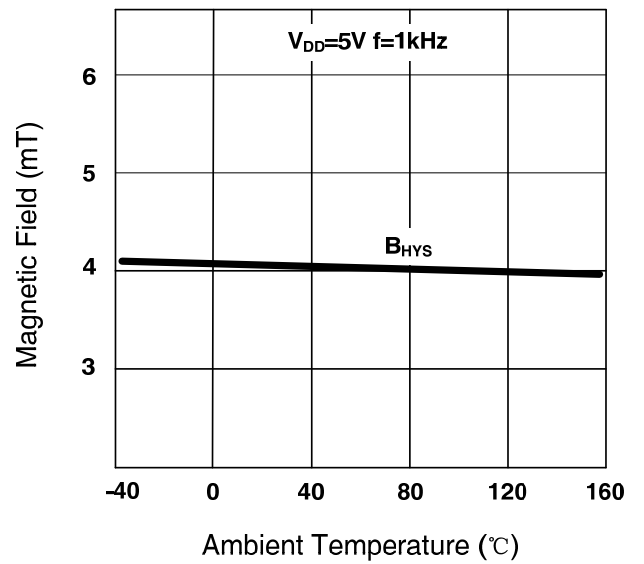

**SC2246**  
**B<sub>OP</sub> and B<sub>RP</sub> vs T<sub>A</sub>**

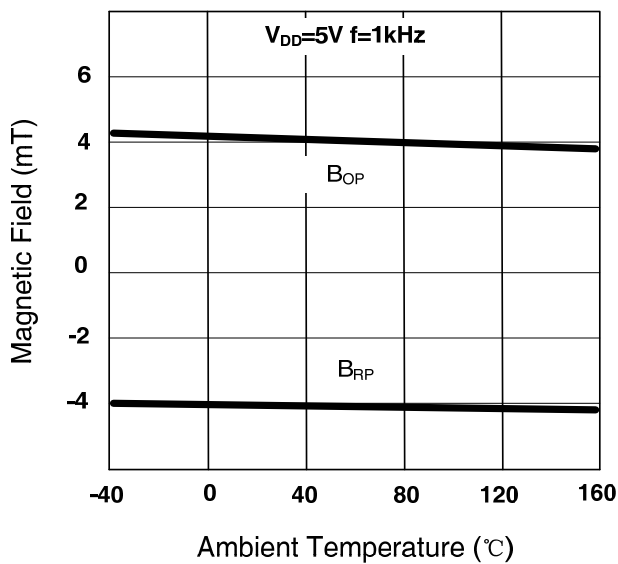

**SC2246**  
**B<sub>HYS</sub> vs T<sub>A</sub>**

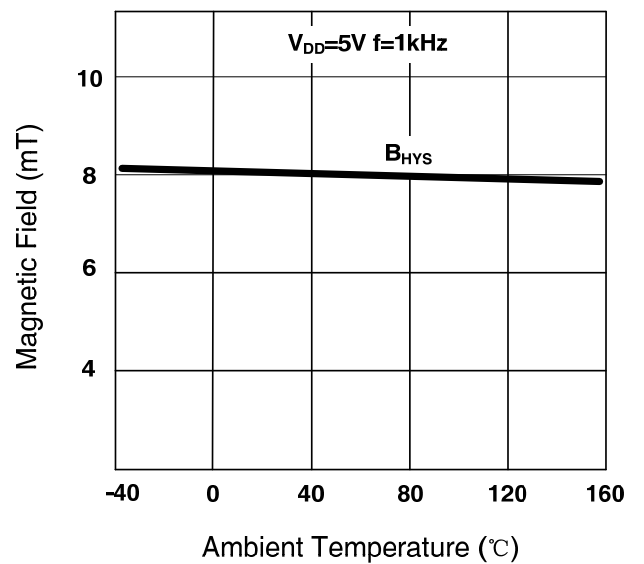



Characteristic Data (Continued)

**SC2248**  
**B<sub>OP</sub> and B<sub>RP</sub> vs T<sub>A</sub>**

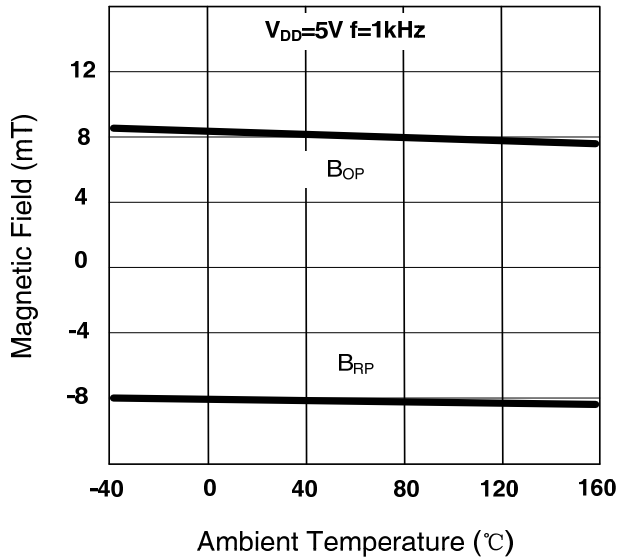

**SC2248**  
**B<sub>HYS</sub> vs T<sub>A</sub>**

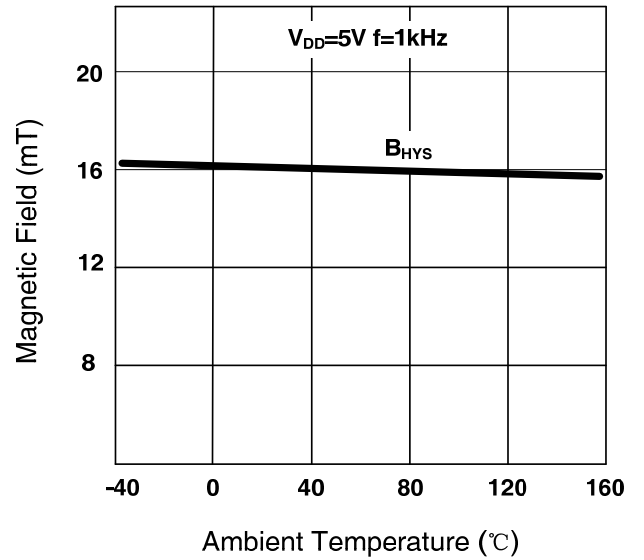

## Function Description Overview

The SC224X device is a chopper-stabilized Hall sensor with a digital latched output for magnetic sensing applications. The device can be powered with a supply voltage between 2.5 and 24V, and continuously survives continuous -10V reverse-battery conditions. The device does not operate when -10 to 2.2V is applied to the VDD terminal (with respect to the GND terminal). In addition, the device can withstand voltages up to 40V for transient durations.

The output of SC224X switches low (turns on) when a magnetic field (South polarity) perpendicular to the Hall element exceeds the operate point threshold,  $B_{OP}$ . After turn-on, the output is capable of sinking 20mA and the output voltage is  $V_{Q(sat)}$ . When the magnetic field is reduced below the release point,  $B_{RP}$ , the device output goes high (turns off). The difference in the magnetic operate and release points is the hysteresis,  $B_{HYS}$ , of the device. This built-in hysteresis allows clean switching of the output even in the presence of external mechanical vibration and electrical noise.

## Functional Block Diagram

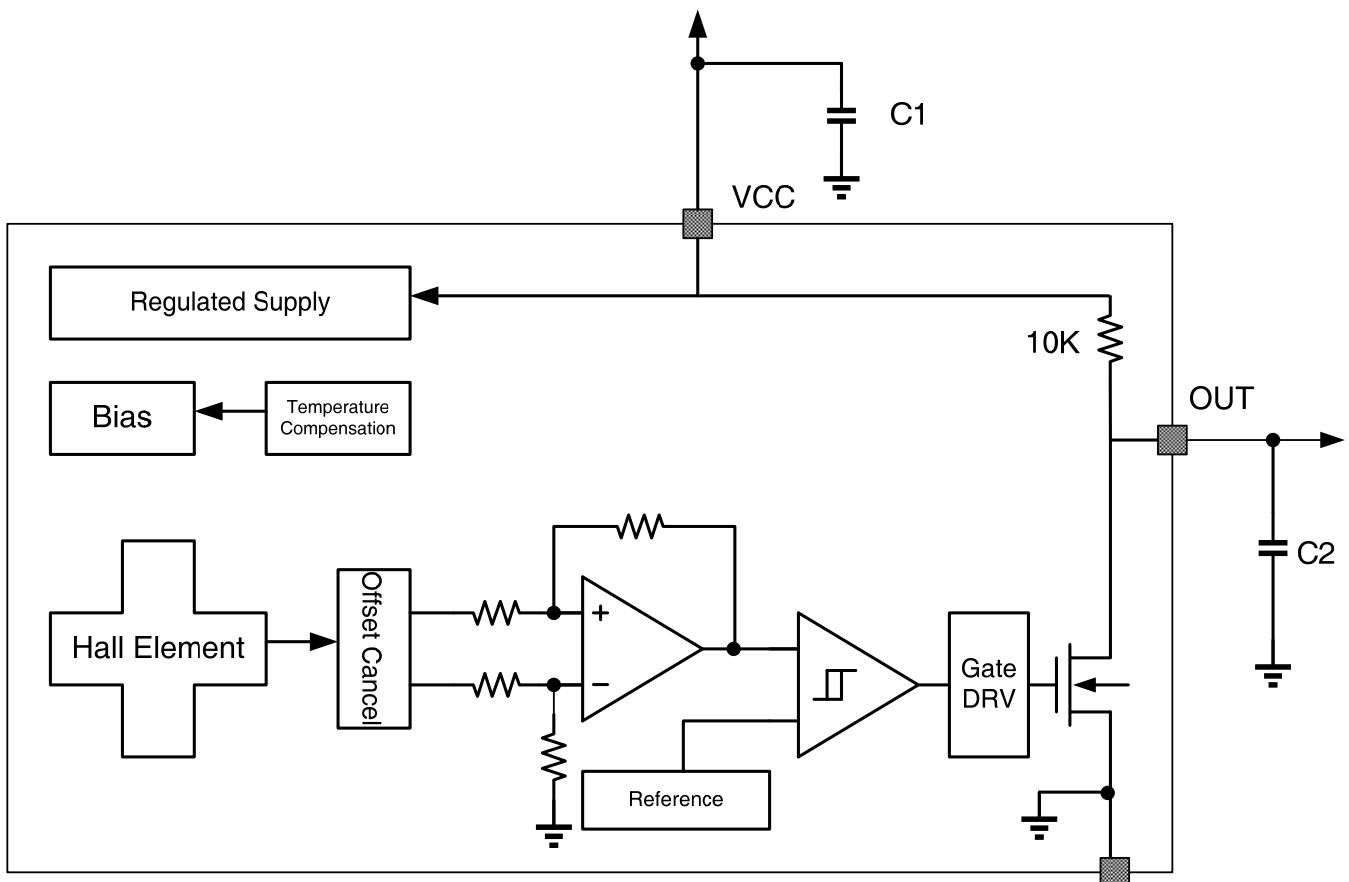

## Field Direction Definition

A positive magnetic field is defined as a South pole near the marked side of the package.

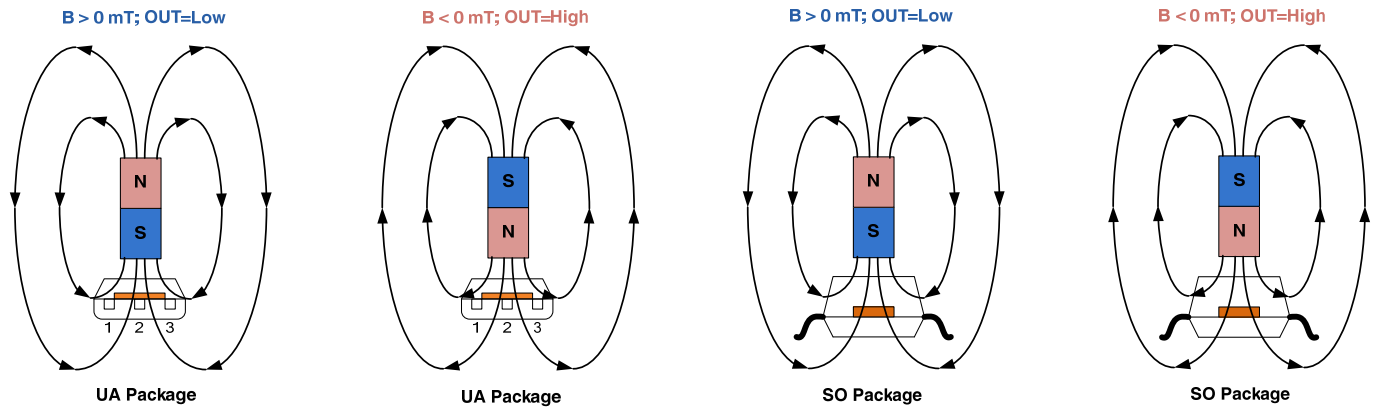

## Transfer Function

Powering-on the device in the hysteresis region, less than  $B_{OP}$  and higher than  $B_{RP}$ , allows an indeterminate output state. The correct state is attained after the first excursion beyond  $B_{OP}$  or  $B_{RP}$ . If the field strength is greater than  $B_{OP}$ , then the output is pulled low. If the field strength is less than  $B_{RP}$ , the output is released.

$B_{OP}$ —magnetic threshold for activation of the device output, turning in ON (low) state

$B_{RP}$ —magnetic threshold for release of the device output, turning in OFF (high) state.

$$B_{HYS} = B_{OP} - B_{RP}$$

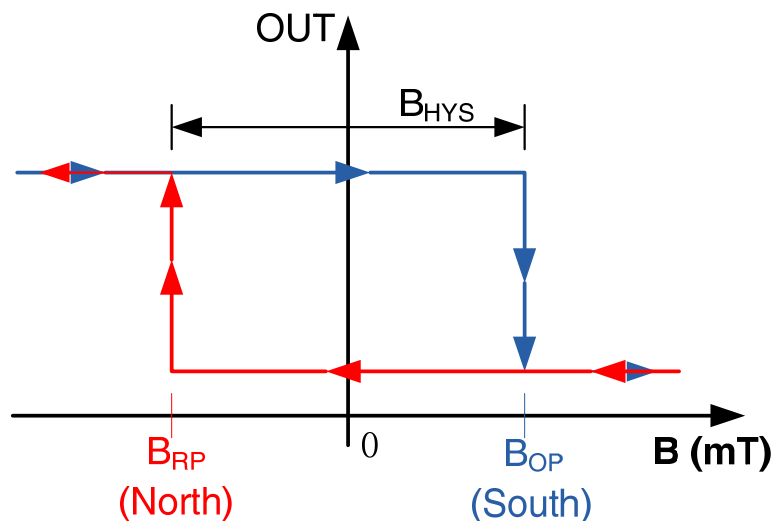

## Typical Application

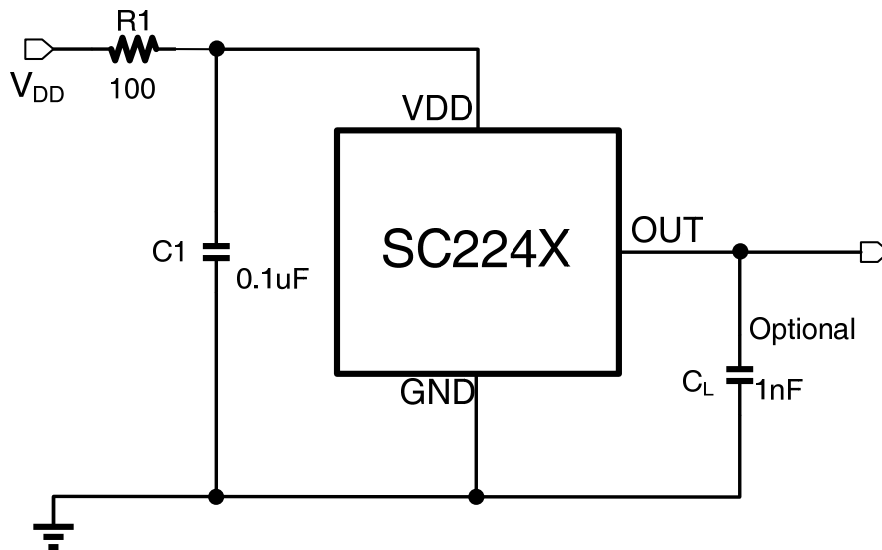

The SC224X contains an on-chip voltage regulator and can operate over a wide supply voltage range. In applications that operate the device from an unregulated power supply, transient protection must be added externally. For applications using a regulated line, EMI/RFI protection may still be required. R1 is for improved CI performance, and could be 100 or 200  $\Omega$  typically.

Select a value for  $C_L$  based on the system bandwidth specifications as:

$$2 \times f \text{ (Hz)} = \frac{1}{2\pi \times R \times C}$$

Most applications do not require this  $C_L$  filtering capacitor.

## Mechanical Dimensions

### 3-Terminal UA Package

Dimension:mm

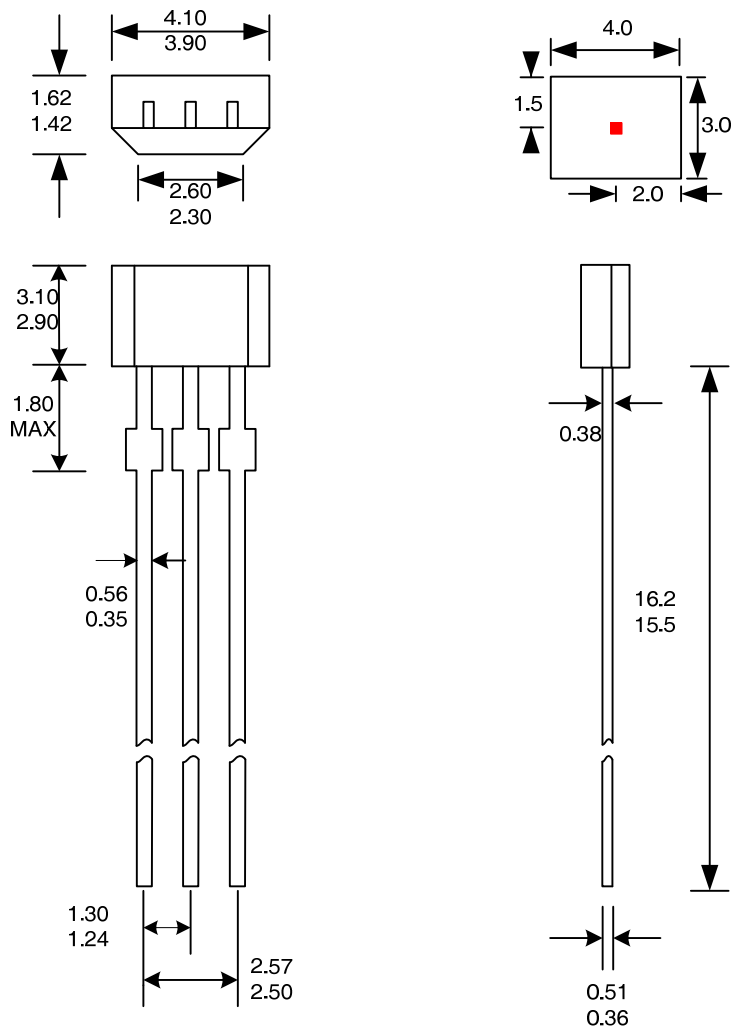

**Notes:**

1. Exact body and lead configuration at vendor's option within limits shown.
2. Height does not include mold gate flash.

Where no tolerance is specified, dimension is nominal.

## Mechanical Dimensions

### 3-Terminal SO Package

Dimension:mm

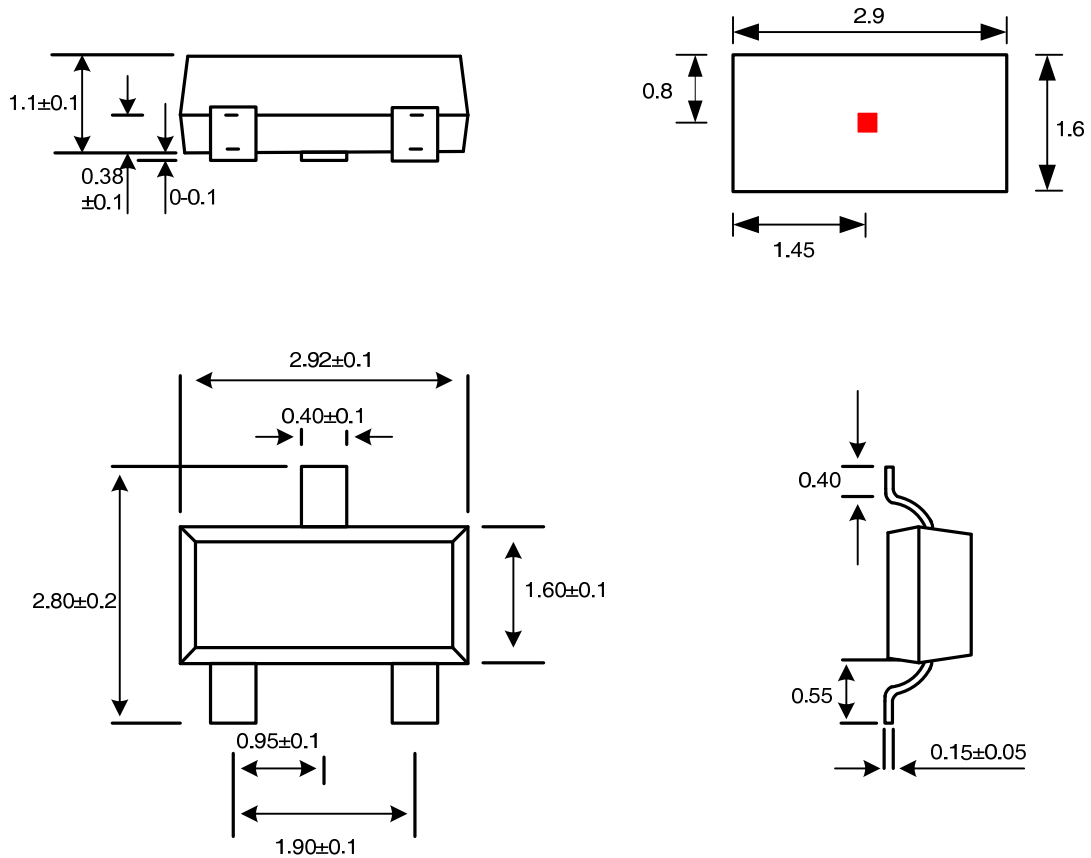

**Notes:**

1. Exact body and lead configuration at vendor's option within limits shown.
2. Height does not include mold gate flash.

Where no tolerance is specified, dimension is nominal.

## X-ON Electronics

Largest Supplier of Electrical and Electronic Components

*Click to view similar products for [Board Mount Hall Effect/Magnetic Sensors](#) category:*

*Click to view products by [Semiment](#) manufacturer:*

Other Similar products are found below :

[HGPRDT005A](#) [AH277AZ4-AG1](#) [AV-10379](#) [AV-10448](#) [SS41C](#) [AH1894-Z-7](#) [TLE4917](#) [50017859-003](#) [TY-13101](#) [TLE4976L](#) [SS85CA](#)  
[BU52002GUL-E2](#) [BU52003GUL-E2](#) [AH277AZ4-BG1](#) [TLE49614MXTSA1](#) [AH211Z4-AG1](#) [AH3360-FT4-7](#) [TLE4941-1](#) [SS460S-](#)  
[100SAMPLE](#) [50065820-03](#) [AH374-P-A](#) [AH3372-P-B](#) [AH1806-P-A](#) [TLE49595UFXHALA1](#) [SS460P-T2](#) [AH1913-W-7](#) [AH3373-P-B](#)  
[TLE9852QXXUMA1](#) [TLE5046ICAKLRHALA1](#) [AH1903-FA-EVM](#) [AH49FNTR-EVM](#) [AH8502-FDC-EVM](#) [AH3774-P-EVM](#)  
[TLE4998S3XALA1](#) [TLE5011FUMA1](#) [TLE5027CE6747HAMA1](#) [TLE5109A16E1210XUMA1](#) [TLI4966GHTSA1](#) [TLI4906KHTSA1](#)  
[MA710GQ-P](#) [S-57K1NBL2A-M3T2U](#) [S-57P1NBL9S-M3T4U](#) [S-576ZNL2B-L3T2U](#) [S-576ZNL2B-A6T8U](#) [S-57P1NBL0S-M3T4U](#) [S-](#)  
[57A1NSL1A-M3T2U](#) [S-57K1RBL1A-M3T2U](#) [S-57P1NBH9S-M3T4U](#) [S-57P1NBH0S-M3T4U](#) [S-57A1NSH1A-M3T2U](#)