

High Sensitivity Omnipolar Hall-effect Sensor

Features

- Digital Omni-polar Hall-Effect sensor
- High chopping frequency
- Very high sensitivity
- Superior temperature stability
- Supports a wide voltage range
 - 2.5 to 24V
 - Operating from unregulated supply
- Reverse battery protection (up to 28V)
- Over-voltage protection at all pins
- Robust EMC performance
- Solid-state reliability
- Small package
 - 3-pin SIP
 - 3-pin SOT-23

Output State

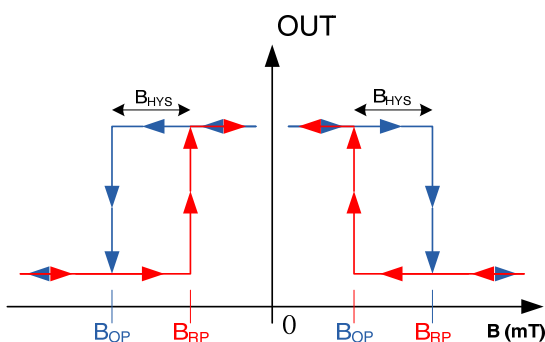

Applications

- Flow meters
- Magnetic encoding
- Proximity sensing
- Garage door openers
- Power sliding doors
- Sunroofs motor

Description

The SC246X family, produced with BiCMOS technology, is a chopper-stabilized Hall Effect Sensor that offers a magnetic sensing solution with superior sensitivity stability over temperature and integrated protection features.

Superior high-temperature performance is made possible through dynamic offset cancellation, which reduces the residual offset voltage normally caused by device over molding, temperature dependencies, and thermal stress. Each device includes on a single silicon chip a voltage regulator, Hall-voltage generator, small-signal amplifier, chopper stabilization, Schmitt trigger, and an open-drain output to sink up to 20mA.

An onboard regulator permits with supply voltages of 2.5 to 24V which makes the device suitable for a wide range of industrial and automotive applications

The device is available in a 3-pin SIP and a plastic SOT23-3 surface mount package. Both packages are lead(Pb) free, with 100% matte tin leadframe plating.

Device Information

| Part Number | Packing | Mounting | Ambient, T _A | B _{OP} (Typ.) | B _{RP} (Typ.) |
|-------------|-----------------------|----------|-------------------------|------------------------|------------------------|
| SC2462UA | Bulk, 1000 pieces/bag | SIP3 | -40°C to 150°C | ±2.5mT | ±1.5mT |
| SC2462SO | Reel, 3000pieces/reel | SOT-23 | | | |
| SC2464UA | Bulk, 1000 pieces/bag | SIP-3 | -40°C to 150°C | ±6.0mT | ±5.0mT |
| SC2464SO | Reel, 3000pieces/reel | SOT-23 | | | |

Terminal configuration and functions

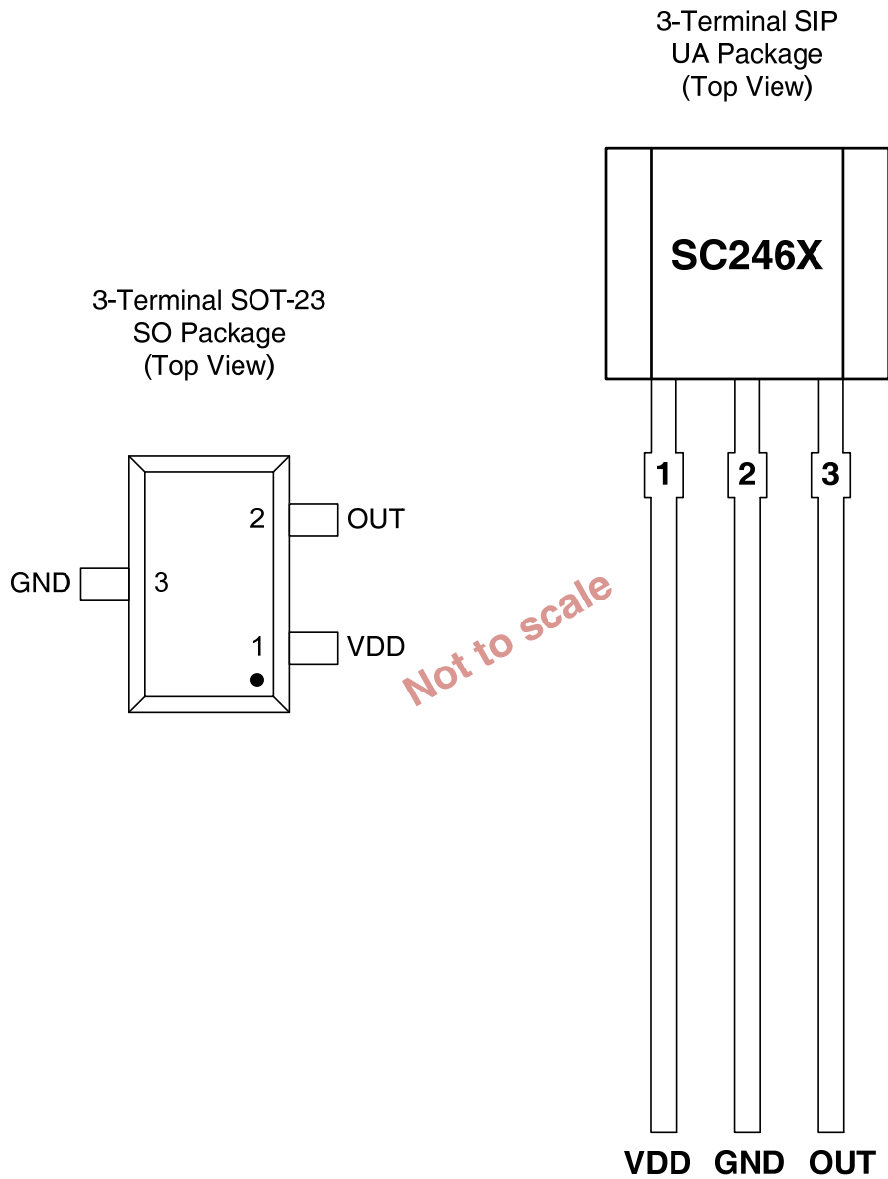

| Name | Terminal | | Type | Description |
|------|----------|----|--------|--------------------------|
| | Number | | | |
| | UA | SO | | |
| VDD | 1 | 1 | PWR | 2.5 to 24 V power supply |
| GND | 2 | 3 | Ground | Ground terminal |
| OUT | 3 | 2 | Output | Output terminal |

Absolute Maximum Ratings

over operating free-air temperature range (unless otherwise noted) ⁽¹⁾

| Parameter | Symbol | Min. | Max. | Units |
|-------------------------------|-------------------|--------------------|------|-------|
| Power supply voltage | V _{DD} | -28 ⁽²⁾ | 28 | V |
| Output terminal voltage | V _{OUT} | -0.5 | 28 | V |
| Output terminal current sink | I _{SINK} | 0 | 30 | mA |
| Operating ambient temperature | T _A | -40 | 150 | °C |
| Maximum junction temperature | T _J | -55 | 165 | °C |
| Storage temperature | T _{STG} | -65 | 175 | °C |

⁽¹⁾Stresses above those listed here may cause permanent damage to the device. Exposure to absolute maximum rating conditions for extended periods may affect device reliability.

⁽²⁾Ensured by design.

ESD Protection

Human Body Model (HBM) tests according to: standard AEC-Q100-002

| Parameter | Symbol | Min. | Max. | Units |
|----------------|------------------|------|------|-------|
| ESD-Protection | V _{ESD} | -4 | 4 | KV |

Thermal Characteristics

| Symbol | Parameter | Test Conditions | Rating | Units |
|-----------------|-------------------------------|--|--------|-------|
| R _{θA} | UA Package thermal resistance | Single-layer PCB, with copper limited to solder pads | 166 | °C/W |
| R _{θA} | SO Package thermal resistance | Single-layer PCB, with copper limited to solder pads | 228 | °C/W |

Electrical Characteristics

over operating free-air temperature range ($V_{DD} = 5.0V$, unless otherwise noted)

| Symbol | Parameter | Test Conditions | Min. | Typ. | Max. | Units |
|--------------|----------------------------------|--|------|------|------|----------|
| V_{DD} | Operating voltage ⁽¹⁾ | $T_J < T_{J(Max.)}$ | 2.5 | -- | 24 | V |
| V_{DDR} | Reverse supply voltage | | -28 | -- | -- | V |
| I_{DD} | Operating supply current | $V_{DD}=2.5$ to 24 V, $T_A=25^\circ C$ | 0.8 | 1.6 | 2.0 | mA |
| | | $V_{DD}=2.5$ to 24 V, $T_A=125^\circ C$ | 0.8 | 1.7 | 2.0 | mA |
| t_{on} | Power-on time | | -- | 35 | 50 | μS |
| I_{QL} | Off-state leakage current | Output Hi-Z | -- | -- | 3 | μA |
| $R_{DS(on)}$ | FET on-resistance | $V_{DD}=5V$, $I_O=10mA$, $T_A=25^\circ C$ | -- | 20 | -- | Ω |
| | | $V_{DD}=5V$, $I_O=10mA$, $T_A=125^\circ C$ | -- | 30 | -- | Ω |
| t_d | Output delay time | $B=B_{RP}$ to B_{OP} | -- | 15 | 25 | μS |
| t_r | Output rise time (10% to 90%) | $R1=1Kohm$ $C_o=50pF$ | -- | -- | 0.5 | μS |
| t_f | Output fall time (90% to 10%) | $R1=1Kohm$ $C_o=50pF$ | -- | -- | 0.2 | μS |

(1) Maximum voltage must be adjusted for power dissipation and junction temperature, see Thermal Characteristics

Magnetic Characteristics

over operating free-air temperature range (unless otherwise noted)

| Symbol | Parameter | Test Conditions | Min. | Typ. | Max. | Units |
|--------------------------------------|----------------|------------------|------|------|------|-------|
| f_{BW} | Bandwidth | | 20 | -- | -- | kHz |
| SC2462 $\pm 2.5 / \pm 1.5$ mT | | | | | | |
| B_{OP} | Operated point | $T_A=25^\circ C$ | 1.5 | 2.5 | 3.5 | mT |
| B_{RP} | Release point | | 0.5 | 1.5 | 2.5 | mT |
| B_{HYS} | Hysteresis | | -- | 1.0 | -- | mT |
| SC2464 $\pm 6.0 / \pm 5.0$ mT | | | | | | |
| B_{OP} | Operated point | $T_A=25^\circ C$ | 5.0 | 6.0 | 7.0 | mT |
| B_{RP} | Release point | | 4.0 | 5.0 | 6.0 | mT |
| B_{HYS} | Hysteresis | | -- | 1.0 | -- | mT |

1mT=10Gs

Magnetic flux density, B , is indicated as a negative value for North-polarity magnetic fields, and as a positive value for South-polarity magnetic fields.

Characteristic Data

I_{DD} vs V_{DD}

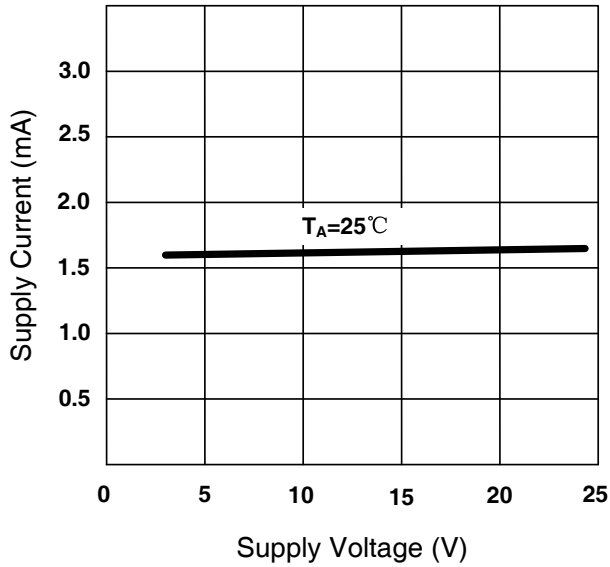

I_{DD} vs T_A

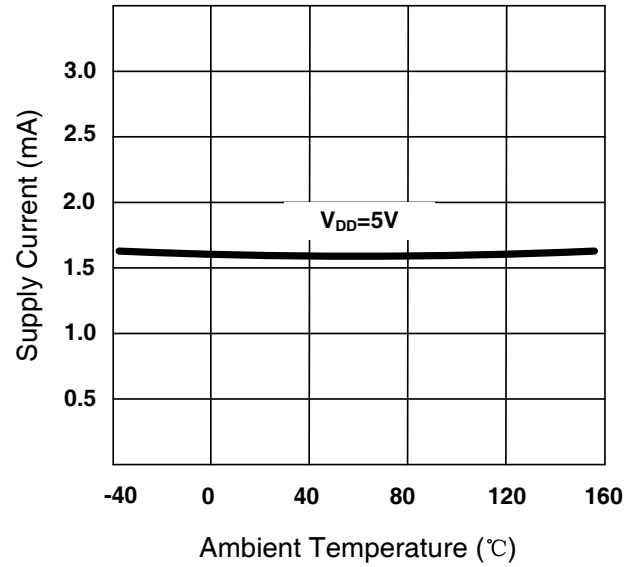

$V_{Q(sat)}$ vs V_{DD}

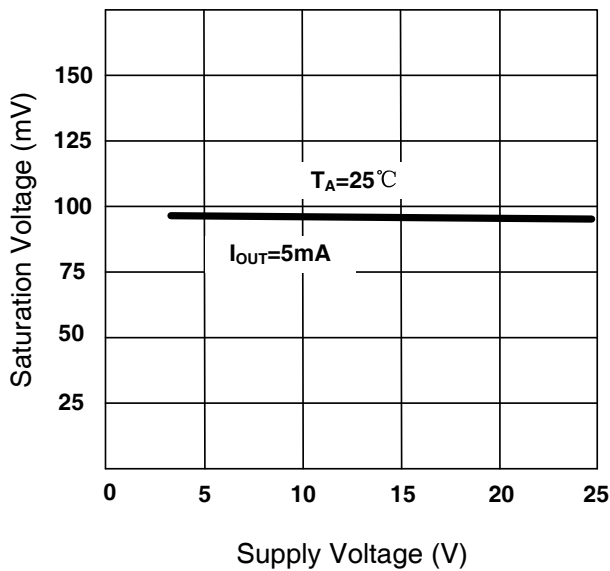

$V_{Q(sat)}$ vs T_A

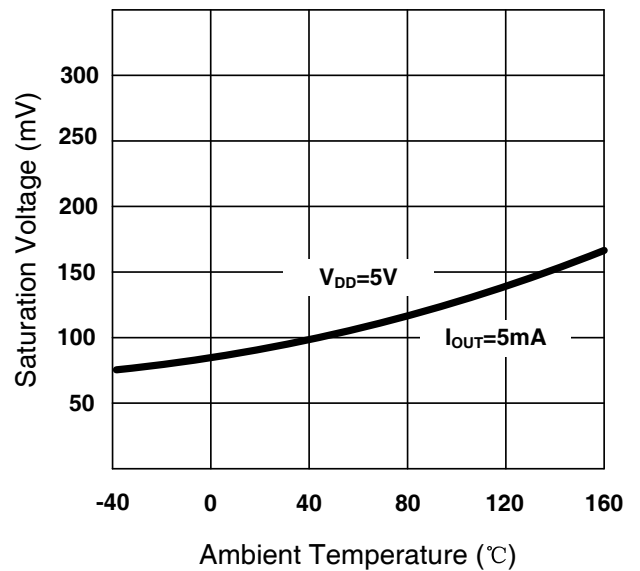

Characteristic Data (Continued)

SC2462
 B_{OP} and B_{RP} vs T_A

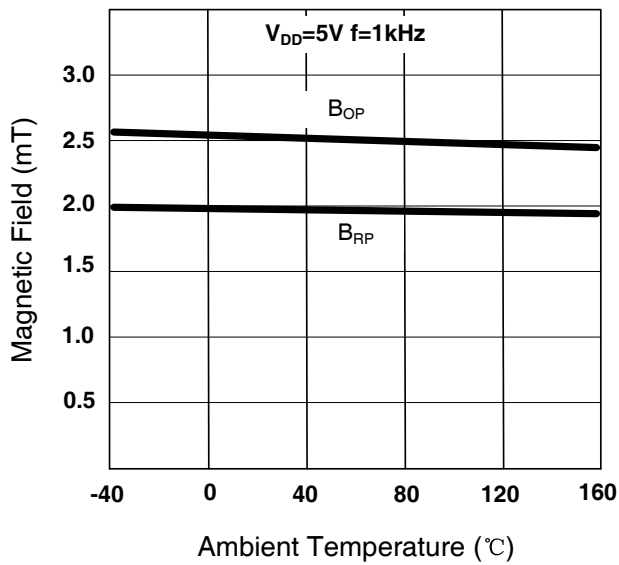

SC2462
 B_{HYS} vs T_A

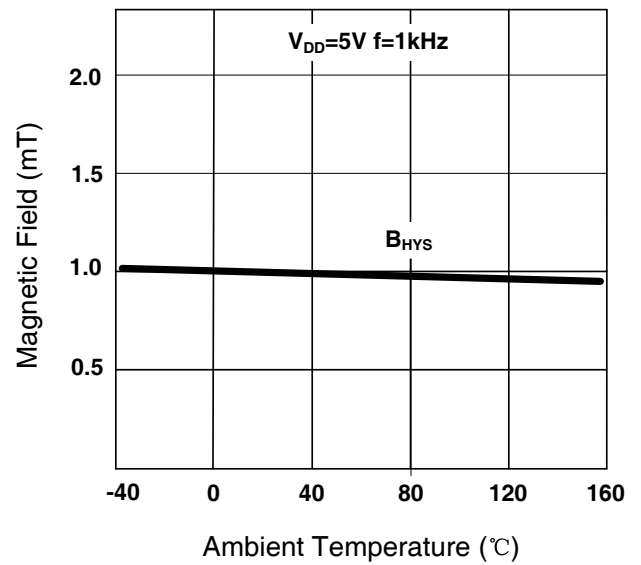

SC2464
 B_{OP} and B_{RP} vs T_A

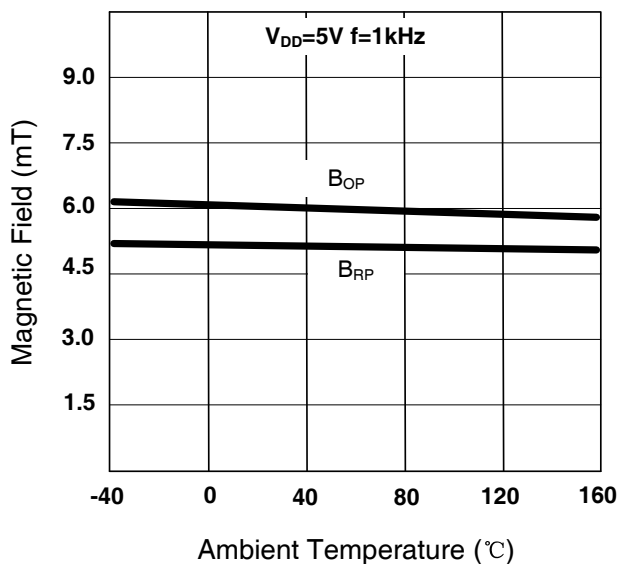

SC2464
 B_{HYS} vs T_A

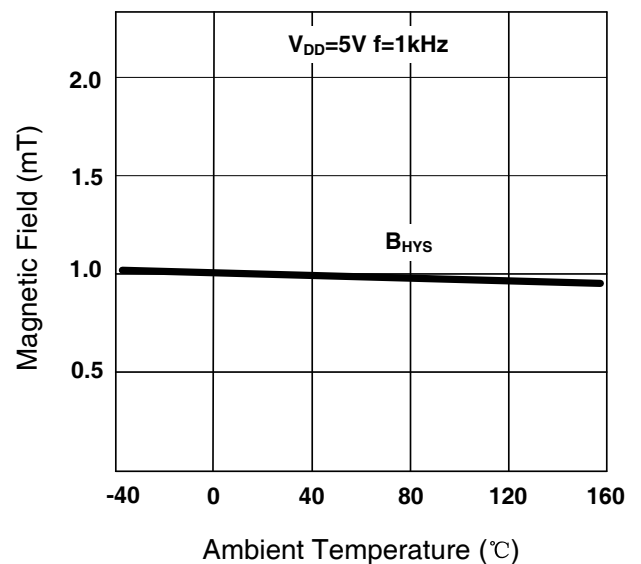

Functional Block Diagram

The SC246X device is a chopper-stabilized Hall sensor with a digital latched output for magnetic sensing applications. The device can be powered with a supply voltage between 2.5 and 24V, and continuously survives continuous -28V reverse-battery conditions. The device does not operate when -28 to 2.2V is applied to the VDD terminal (with respect to the GND terminal). In addition, the device can withstand voltages up to 40V for transient durations.

The output of SC246X switches low (turns on) when a magnetic field (South or North polarity) perpendicular to the Hall element exceeds the operate point threshold, B_{OP} . After turn-on, the output is capable of sinking 20mA and the output voltage is $V_{Q(sat)}$. When the magnetic field is reduced below the release point, B_{RP} , the device output goes high (turns off). The difference in the magnetic operate and release points is the hysteresis, B_{HYS} , of the device. This built-in hysteresis allows clean switching of the output even in the presence of external mechanical vibration and electrical noise.

An external output pull-up resistor is required on the OUT terminal. The OUT terminal can be pulled up to V_{DD} or to a different voltage supply. This allows for easier interfacing with controller circuits.

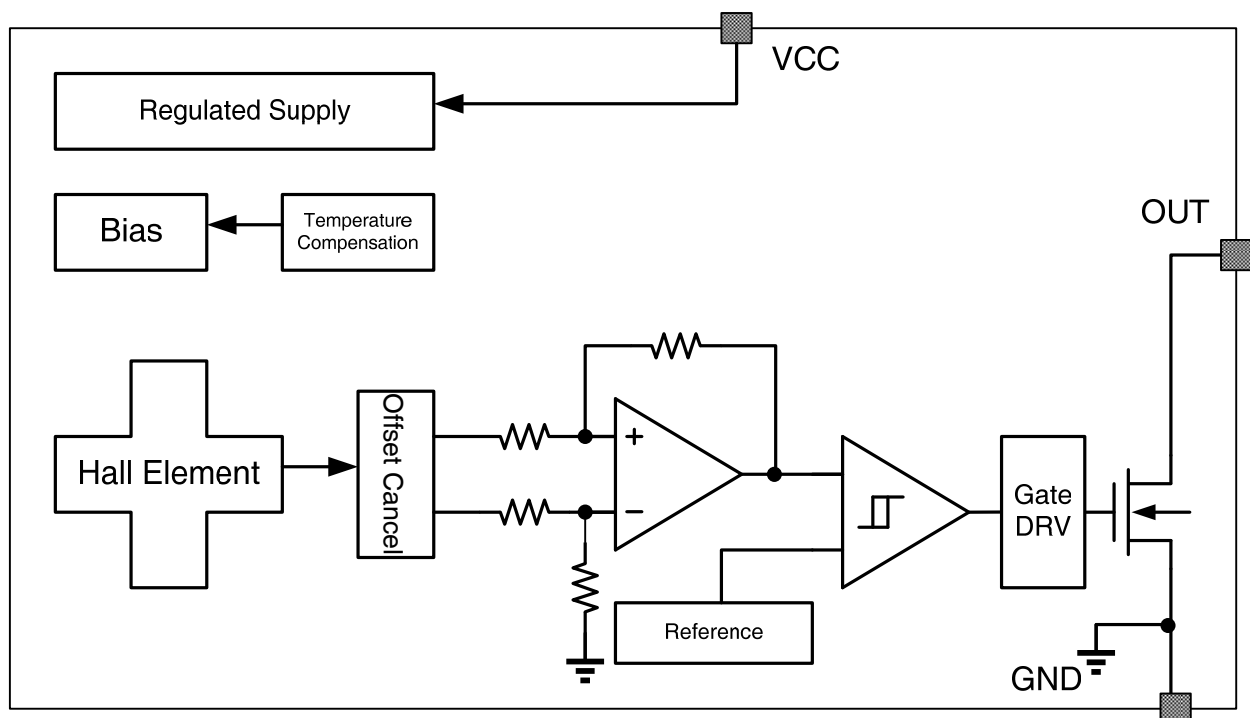

Field Direction Definition

A positive magnetic field is defined as a South pole near the marked side of the package.

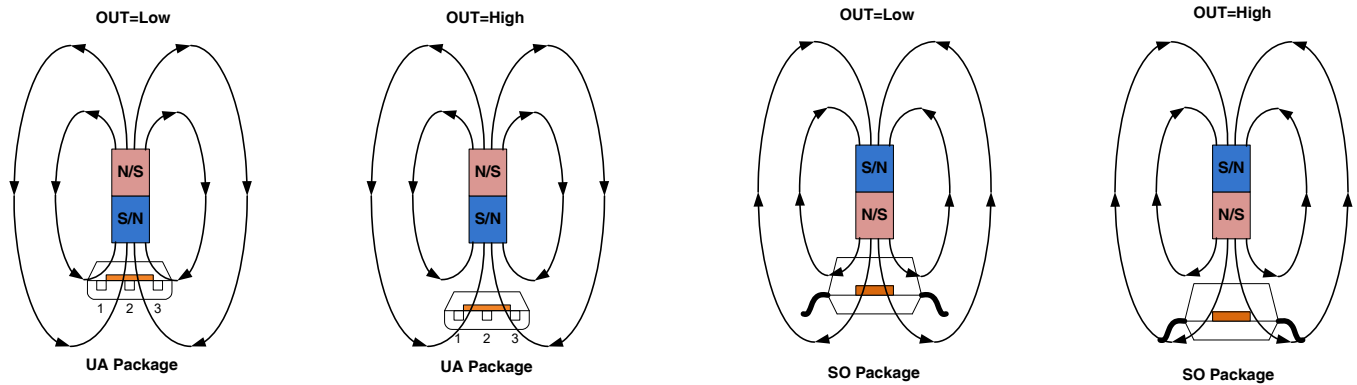

Transfer function

The SC246X exhibits “Omnipolar” magnetic characteristics. It means the device reacts to both North and South magnetic pole. The purpose is to detect the presence of any magnetic field applied on the device. This mode of operation simplifies customer production processes by avoiding the need to detect the Hall sensor pole active on the magnet used in the application. Therefore, the “Omnipolar” magnetic behaviour helps customers by removing the need of magnet pole detection system during production phase.

Powering-on the device in the hysteresis region, less than B_{OP} and higher than B_{RP} , allows an indeterminate output state. The correct state is attained after the first excursion beyond B_{OP} or B_{RP} . If the field strength is greater than B_{OP} , then the output is pulled low. If the field strength is less than B_{RP} , the output is released.

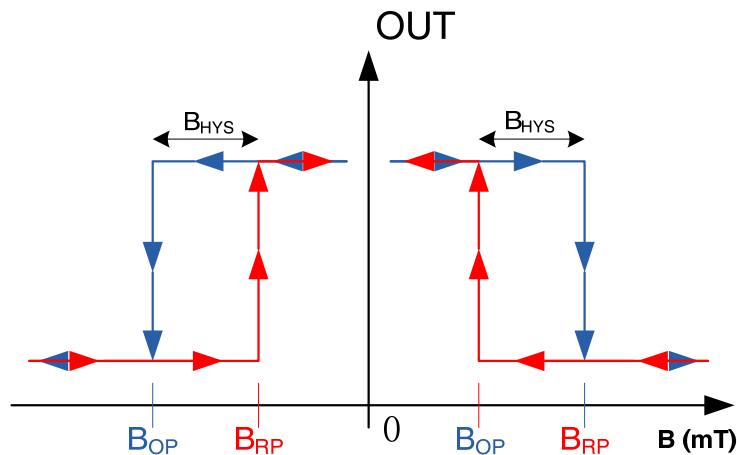

Mechanical Dimensions

3-Terminal UA Package

Dimension:mm

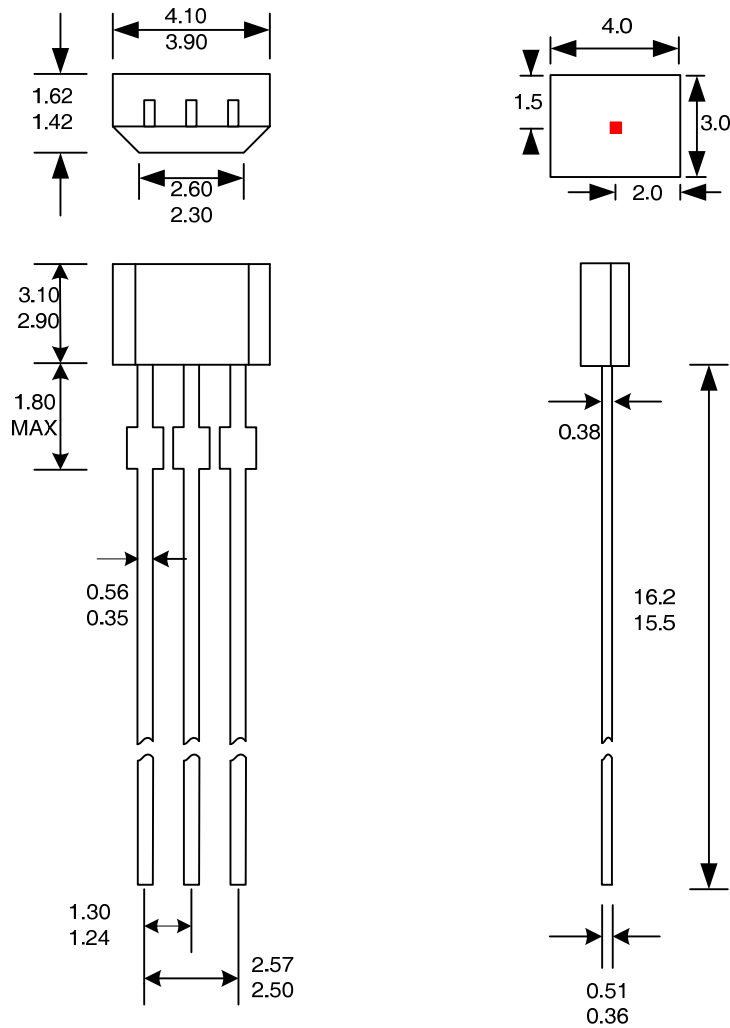

Notes:

1. Exact body and lead configuration at vendor's option within limits shown.
2. Height does not include mold gate flash.

Where no tolerance is specified, dimension is nominal.

Mechanical Dimensions

3-Terminal SO Package

Dimension:mm

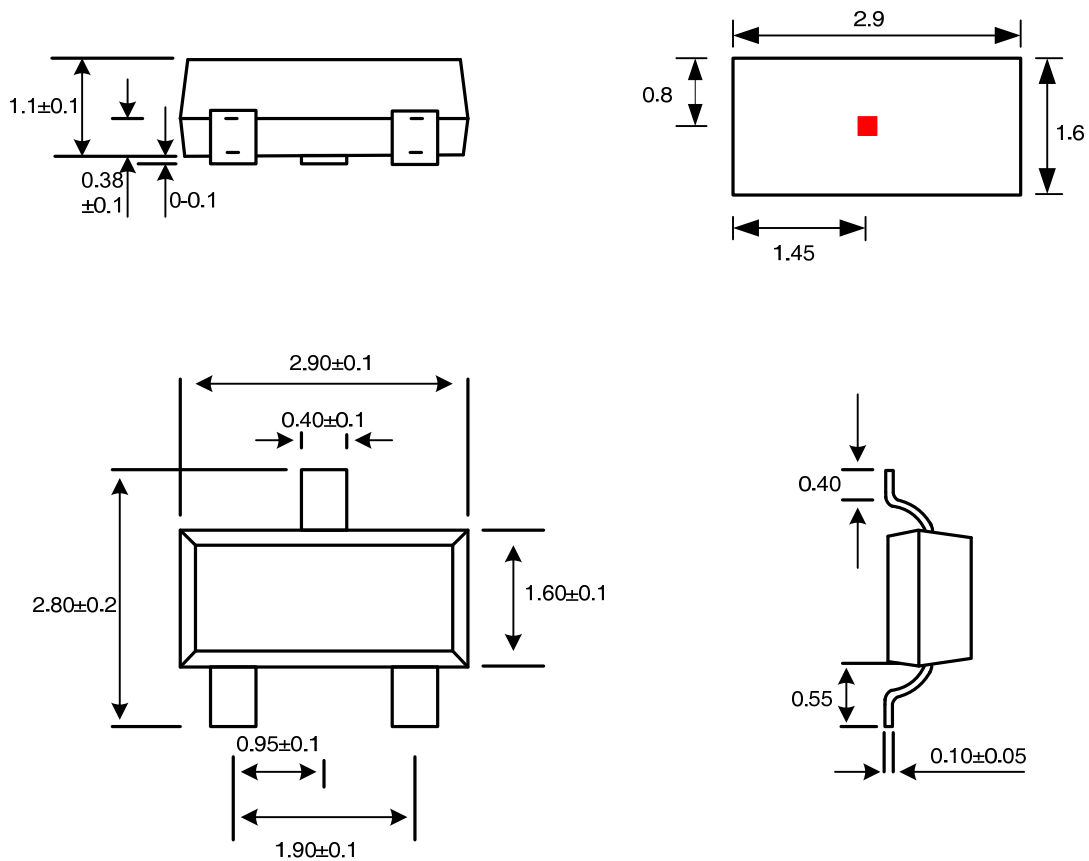

Notes:

1. Exact body and lead configuration at vendor's option within limits shown.
2. Height does not include mold gate flash.

Where no tolerance is specified, dimension is nominal.

X-ON Electronics

Largest Supplier of Electrical and Electronic Components

Click to view similar products for [Industrial Hall Effect/Magnetic Sensors](#) category:

Click to view products by [Semiment](#) manufacturer:

Other Similar products are found below :

[GT-13013](#) [GT-13040](#) [GT-14114](#) [DRR-129\(62-68\)](#) [ATS682LSHTN-T](#) [SR4P2-C7](#) [GT-13012](#) [GT-14049](#) [GT-14067](#) [GT-14132](#) [GT-18030](#)
[103FW12-R3](#) [A1155LLHLT-T](#) [SMSA2P30CG](#) [P2D-000](#) [GN 55.2-SC-15-3](#) [GN 55.2-SC-5-3](#) [MZA70175](#) [103FW41-R1](#) [KJR-D100AN-](#)
[DNA-VE](#) [KJR-D100AN-DNIA-V2](#) [SR-10018](#) [115L 14E 502 W06017](#) [ATS128LSETN-T](#) [TLE4906LHALA1](#) [TLE49452LHALA1](#)
[BU52013HFV-TR](#) [MRMS591A](#) [103SR14A-1](#) [MZT7-03VPS-KR0](#) [MZT7-03VPS-KW0](#) [MZT8-03VPS-KW0](#) [MZT8-28VPS-KP0](#)
[A1326LLHLX-T](#) [A1326LLHLT-T](#) [A1156LLHLT-T](#) [ACS770LCB-100U-PFF-T](#) [ATS617LSGTN-T](#) [AH49ENTR-G1](#) [SS360PT](#) [SS311PT](#)
[GN 55.2-ND-15-3](#) [GN 55.2-ND-18-3](#) [GN 55.2-ND-4-3](#) [GN 55.2-ND-8-3](#) [GN 55.2-SC-10-3](#) [GN 55.4-ND-10-7,5-2](#) [GN 55.4-ND-12-9,5-2,5](#)
[GN 55.4-ND-26-20,3-5](#) [GN 55.4-ND-7,5-4-1,5](#)