

**1200V SiC MOSFET**

$V_{DS}$	1200 V
$R_{DS,on}$	38 m $\Omega$
$I_D$ (TC=25°C)	66 A
$T_{j,max}$	175°C

**Features**

- High speed switching
- Reliable body diode
- All parts tested to greater than 1,400V
- Avalanche tested to 400mJ\*
- Driver source pin for gate driving

**Benefits**

- Lower capacitance
- Higher system efficiency
- Easy to parallel
- Lower Switching Loss
- Longer clearance distance

**Applications**

- Solar Inverters
- Switch mode power supplies, UPS
- Induction heating and welding
- EV charging stations
- High voltage DC/DC converters
- Motor drives

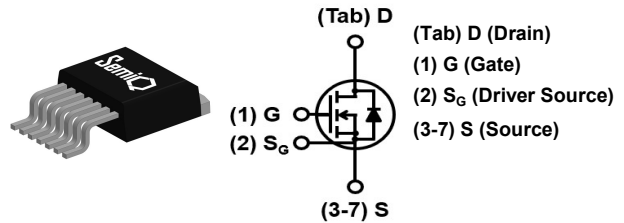
**Package**

Part #	Package	Marking
GP2T040A120J	TO-263-7L	2T040A120J

**Maximum Ratings, at  $T_j=25^\circ\text{C}$ , unless otherwise specified**

Characteristics	Symbol	Conditions	Values	Unit
Drain-Source Voltage	$V_{rated}$	$V_{GS}=0V, I_{DS}=1\mu A$	1200	V
Continuous Drain Current	$I_D$	$T_C=25^\circ\text{C}, T_j=175^\circ\text{C}$	66	A
		$T_C=100^\circ\text{C}, T_j=175^\circ\text{C}$	49	
Pulsed Drain Current	$I_{D,pulse}^*$	$T_C=25^\circ\text{C}$	160	
Gate Source Voltage	$V_{GSmax}$		-10/25	V
	$V_{GSop}$	Recommended operational	-5/20	
Power Dissipation	$P_{tot}$	$T_C=25^\circ\text{C}$	357	W
Operating & Storage Temperature	$T_j, T_{storage}$	Continuous	-55...175	$^\circ\text{C}$
Single Pulse Avalanche Energy	$E_{AS}$	$L=1.0mH, I_{AS}=28.3A, V=50V$	400	mJ

**Thermal Characteristics**

Characteristics	Symbol	Conditions	Values			Unit
			min.	typ.	max.	
Thermal Resistance, Junction to Case	$R_{thJC}$		-	0.33	0.42	$^\circ\text{C/W}$
Thermal Resistance, Junction to Ambient	$R_{thJA}$		-	-	40.0	

\* Pulse width is limited by  $T_{j,max}$

# 1200V SiC MOSFET

# GP2T040A120J

Static Electrical Characteristics, at  $T_j=25^\circ\text{C}$ , unless otherwise specified

Characteristics	Symbol	Conditions	Values			Unit
			min.	typ.	max.	
Drain-Source Breakdown Voltage	$BV_{DSS}$	$I_{DS}=1\text{mA}$	1200	-	-	V
Zero Gate Voltage Drain Current	$I_{DSS}$	$V_{DS}=1200\text{V}, V_{GS}=0\text{V}$	-	0.1	1.0	$\mu\text{A}$
		$V_{DS}=1200\text{V}, V_{GS}=0\text{V}, T_j=175^\circ\text{C}$	-	1	-	
Gate-Source Leakage Current	$I_{GSS+}$	$V_{GS}=20\text{V}, V_{DS}=0\text{V}$	-	<+10	100	nA
	$I_{GSS-}$	$V_{GS}=-5\text{V}, V_{DS}=0\text{V}$	-	>-10	-100	
Gate Threshold Voltage	$V_{GS(th)}$	$V_{GS}=V_{DS}, I_{DS}=10\text{mA}$	1.8	2.4	4	V
		$V_{GS}=V_{DS}, I_{DS}=10\text{mA}, T_j=125^\circ\text{C}$	-	1.8	-	
		$V_{GS}=V_{DS}, I_{DS}=10\text{mA}, T_j=175^\circ\text{C}$	-	1.6	-	
Drain-Source On-Resistance	$R_{DS(on)}$	$V_{GS}=20\text{V}, I_{DS}=40\text{A}$	-	38	52	m $\Omega$
		$V_{GS}=20\text{V}, I_{DS}=20\text{A}$	-	35	45	
		$V_{GS}=20\text{V}, I_{DS}=40\text{A}, T_j=125^\circ\text{C}$	-	56	-	
		$V_{GS}=20\text{V}, I_{DS}=40\text{A}, T_j=175^\circ\text{C}$	-	73	-	
Transconductance	$g_{fs}$	$V_{DS}=20\text{V}, I_{DS}=40\text{A}$	-	16	-	S
Gate Input Resistance	$R_G$	$f=1\text{MHz}, V_{AC}=25\text{mV}, \text{D-S Short}$	-	1.9	-	$\Omega$

AC Electrical Characteristics, at  $T_j=25^\circ\text{C}$ , unless otherwise specified

Characteristics	Symbol	Conditions	Values			Unit
			min.	typ.	max.	
Input Capacitance	$C_{ISS}$	$V_{GS}=0\text{V},$ $V_{DS}=1000\text{V},$ $f=200\text{kHz}, V_{AC}=25\text{mV}$	-	3192	-	pF
Output Capacitance	$C_{OSS}$		-	132	-	
Reverse Transfer Capacitance	$C_{RSS}$		-	7	-	
Coss Stored Energy	$E_{OSS}$		-	77	-	
Turn-On Switching Energy	$E_{ON}$	$V_{DD}=800\text{V}, I_{DS}=40\text{A},$ $R_{G(ext)}=4.3,$	-	515	-	$\mu\text{J}$
Turn-Off Switching Energy	$E_{OFF}$	$V_{GS}=-5/+20\text{V}, L=273\mu\text{H},$	-	89	-	
Total Switching Energy	$E_{TOT}$	$\text{FWD}=\text{GP2T040A120J}$	-	604	-	
Turn-On Delay Time	$t_{D(on)}$	$V_{DD}=800\text{V}, I_{DS}=40\text{A},$ $R_{G(ext)}=4.3, V_{GS}=-5/+20\text{V},$ $L=273\mu\text{H},$ $\text{FWD}=\text{GP2T040A120J}$	-	14	-	ns
Rise Time	$t_R$		-	5	-	
Turn-Off Delay Time	$t_{D(off)}$		-	28	-	
Fall Time	$t_F$		-	12	-	
Total Gate Charge	$Q_G$		-	112	-	
Gate to Source Charge	$Q_{GS}$	$V_{DD}=800\text{V}, I_{DS}=20\text{A},$ $V_{GS}=-5/+20\text{V}$	-	40	-	
Gate to Drain Charge	$Q_{GD}$	-	20	-		

Body Diode Characteristics, at  $T_j=25^\circ\text{C}$ , unless otherwise specified

Characteristics	Symbol	Conditions	Values			Unit
			min.	typ.	max.	
Max Continuous Diode Fwd Current	$I_S$	$V_{GS}=-5\text{V}, T_C=25^\circ\text{C}$	-	-	74	A
Diode Forward Voltage	$V_{SD}$	$V_{GS}=-5\text{V}, I_{SD}=20\text{A}$	-	3.8	-	V
Reverse Recovery Time	$t_{RR}$	$I_{SD}=40\text{A}, V_R=800\text{V}, V_{GS}=-5\text{V},$ $di_F/dt=9.6\text{A/ns}$	-	10	-	ns
Reverse Recovery Charge	$Q_{RR}$		-	394	-	nC
Peak Reverse Recovery Current	$I_{RRM}$		-	67	-	A

## Typical Performance

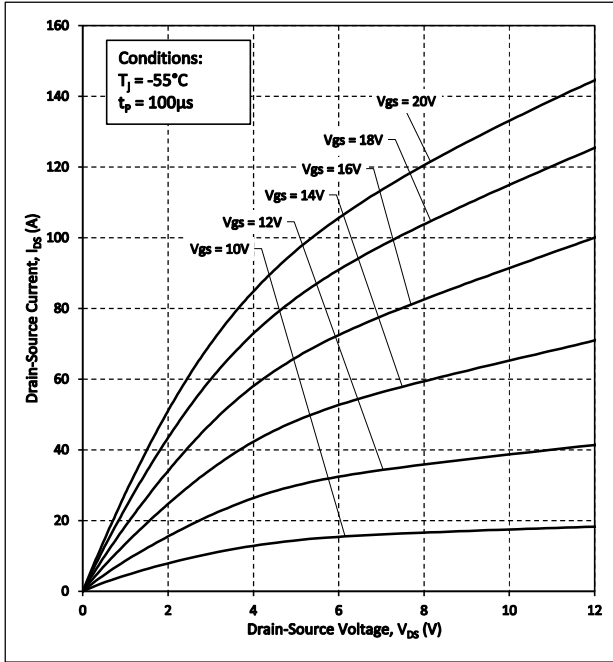

Figure 1. Output Characteristics  $T_j = -55^\circ\text{C}$

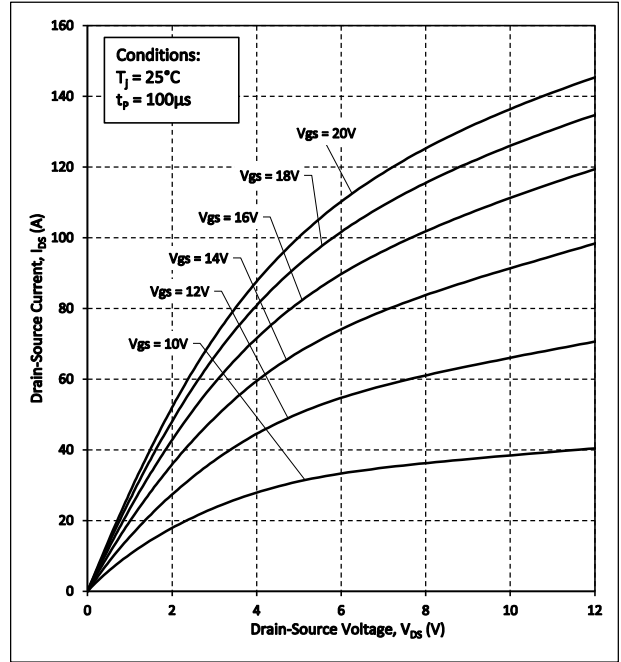

Figure 2. Output Characteristics  $T_j = 25^\circ\text{C}$

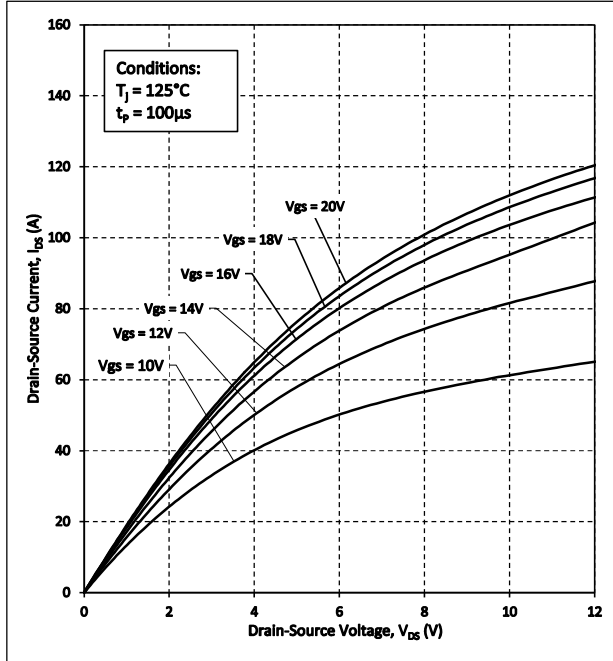

Figure 3. Output Characteristics  $T_j = 125^\circ\text{C}$

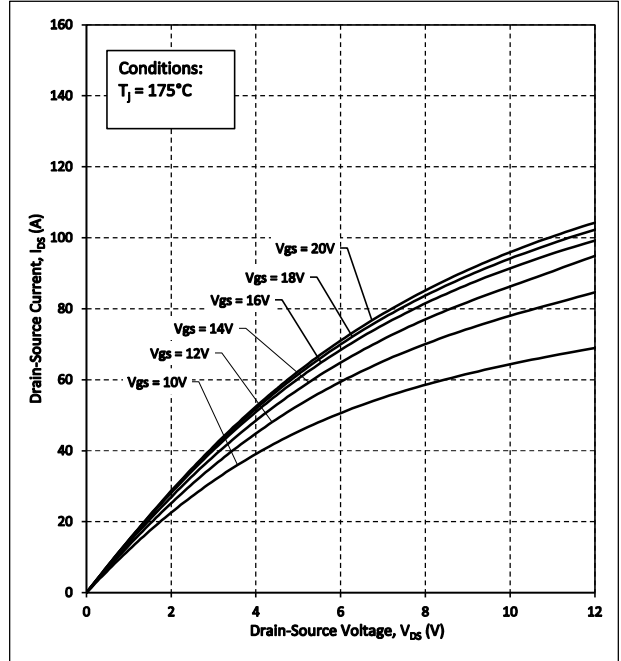

Figure 4. Output Characteristics  $T_j = 175^\circ\text{C}$

# 1200V SiC MOSFET

# GP2T040A120J

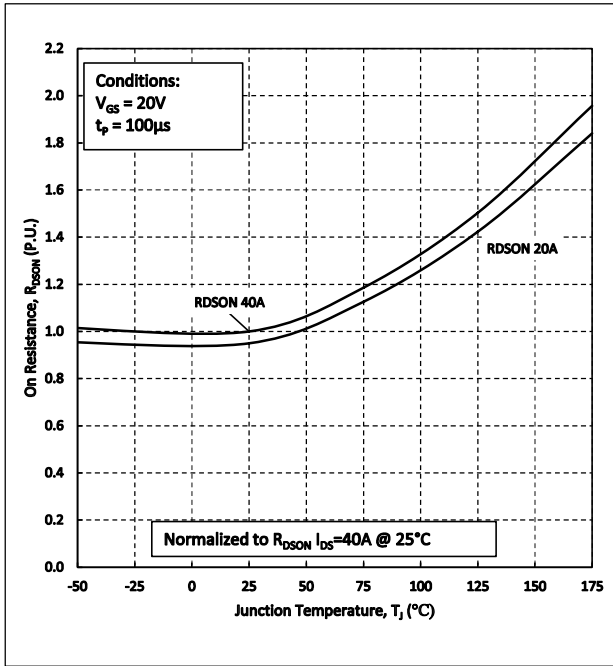

Figure 5. Normalized On-Resistance vs. Temperature

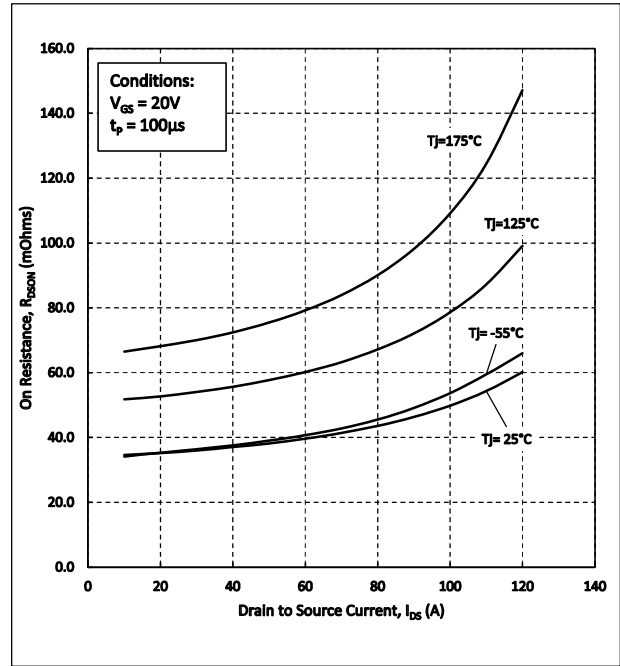

Figure 6. On-Resistance vs. Drain Current For Various Temperature

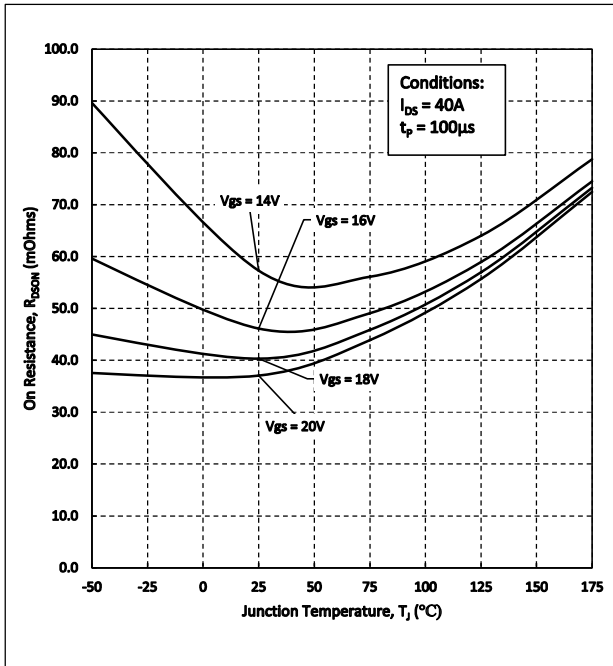

Figure 7. On-Resistance vs. Temperature For Various Gate Voltages

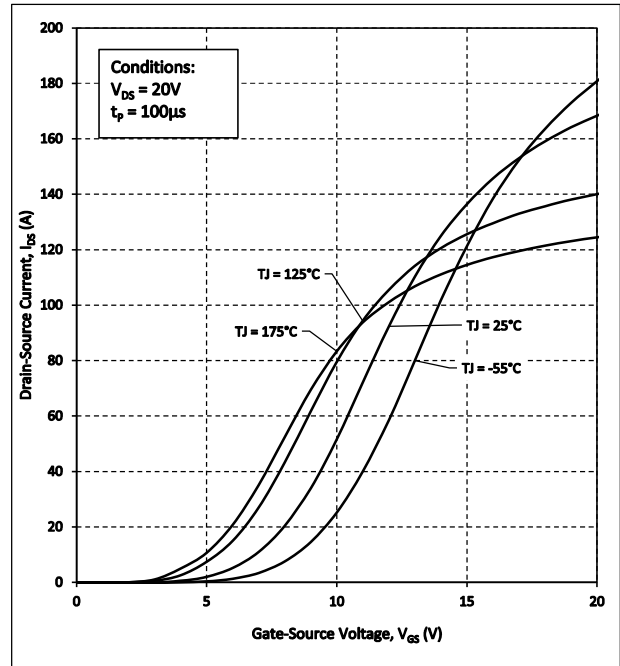

Figure 8. Transfer Characteristic for Various Junction Temperatures

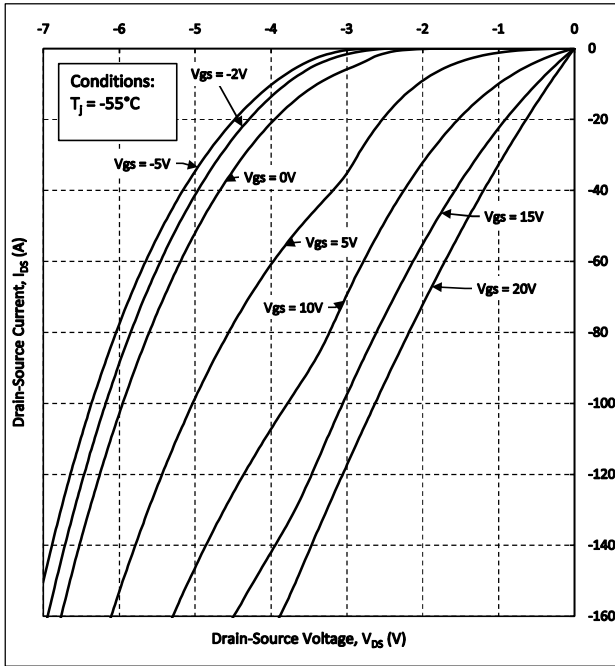

Figure 9. Body Diode Characteristics at  $T_j = -55^\circ\text{C}$

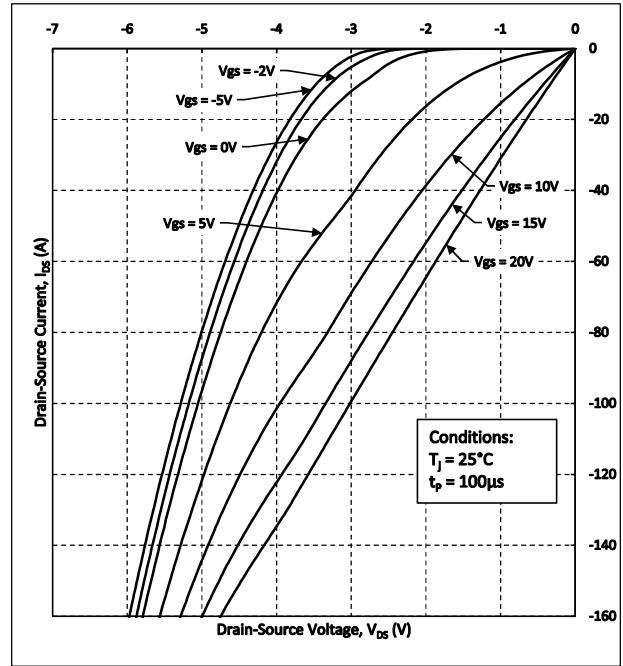

Figure 10. Body Diode Characteristics at  $T_j = 25^\circ\text{C}$

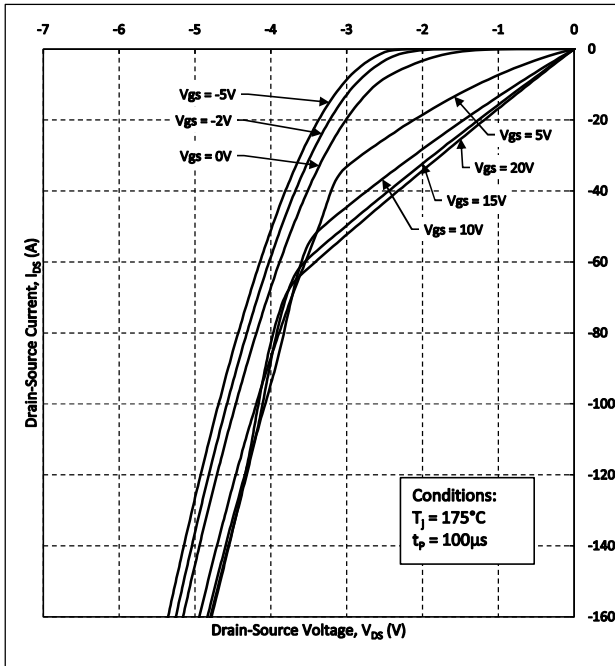

Figure 11. Body Diode Characteristics at  $T_j = 175^\circ\text{C}$

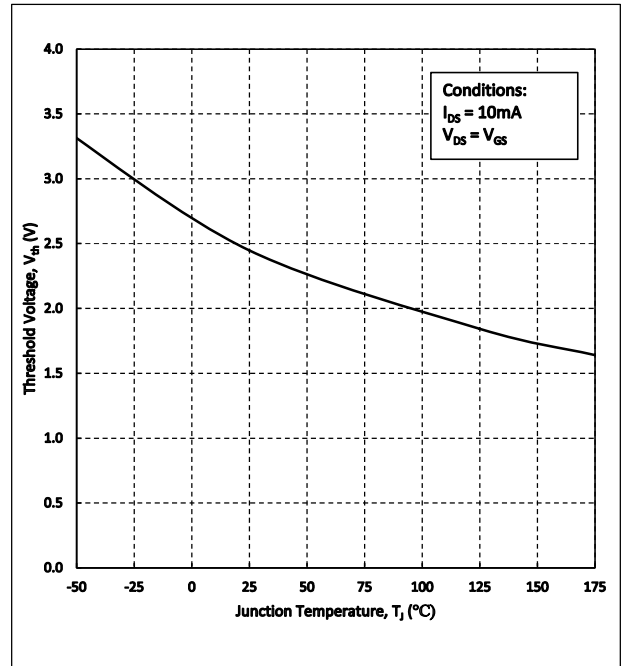

Figure 12. Threshold Voltage vs. Temperature

# 1200V SiC MOSFET

# GP2T040A120J

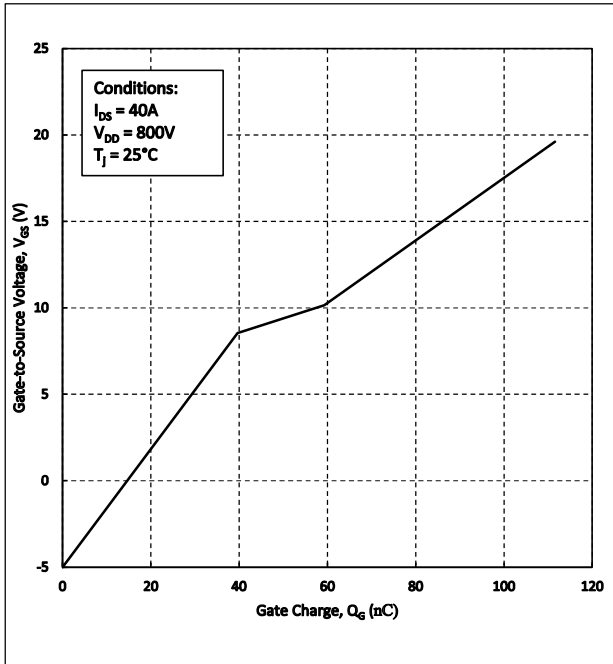

Figure 13. Gate Charge Characteristics

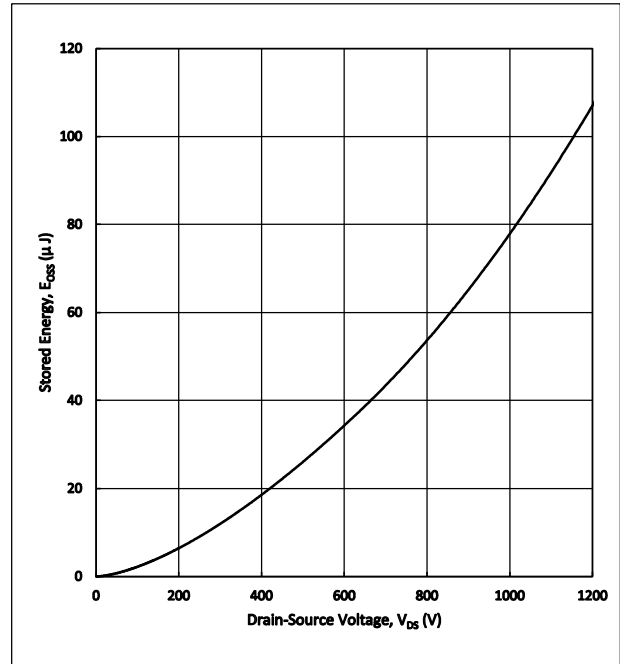

Figure 14. Output Capacitor Stored Energy

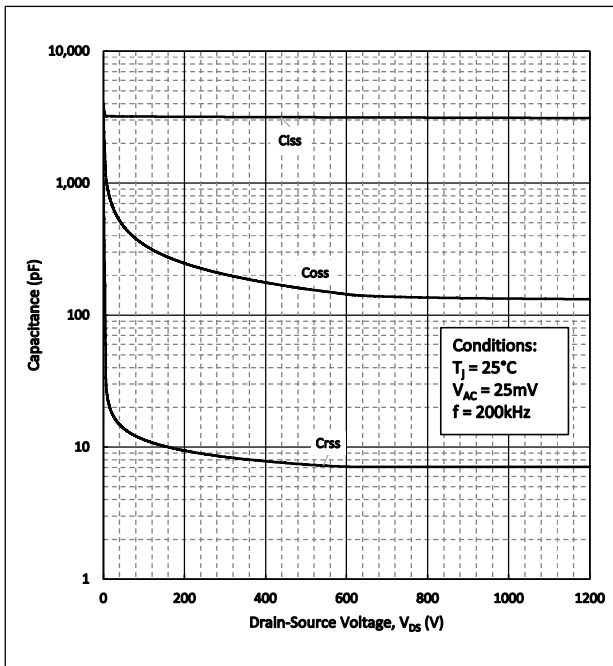

Figure 15. Capacitance vs Drain-Source Voltage

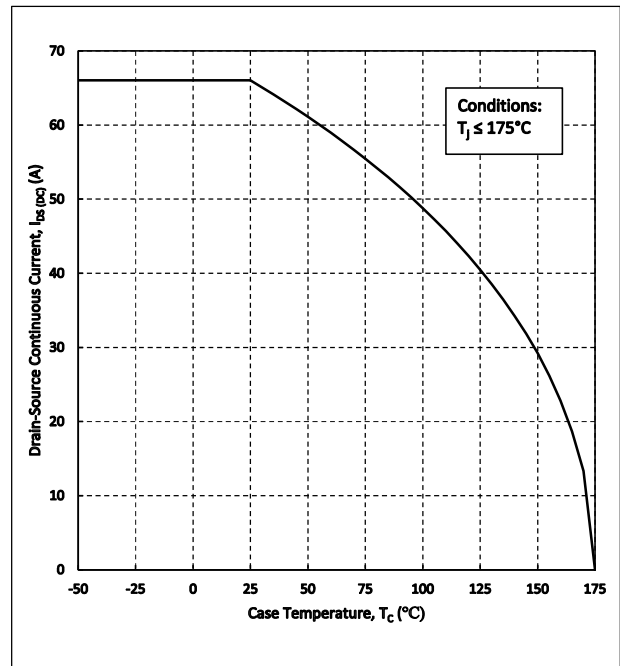

Figure 16. Continuous Drain Current Derating vs. Case Temperature

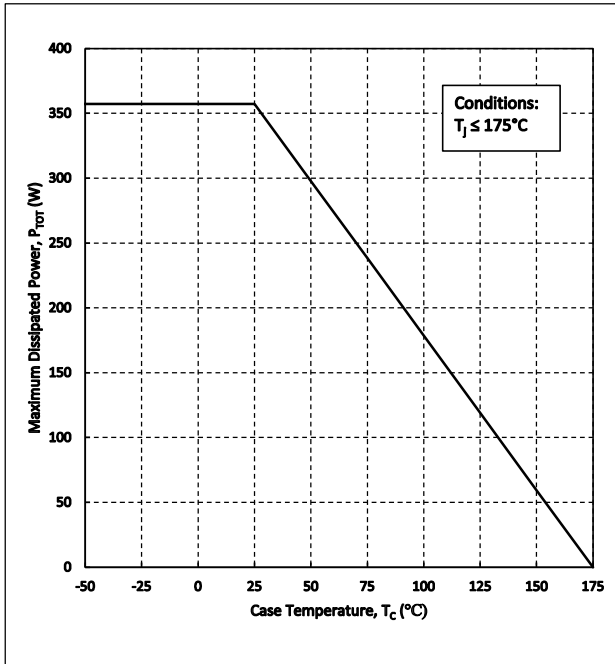

Figure 17. Maximum Power Dissipation Derating vs Case Temperature

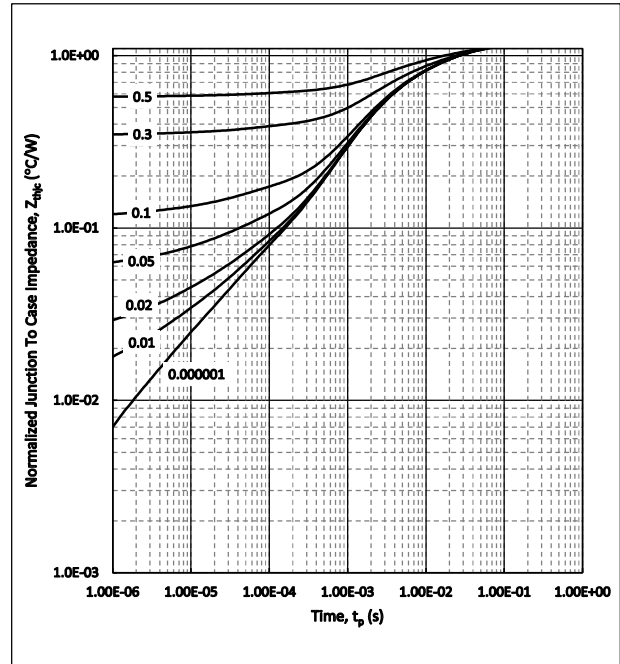

Figure 18. Transient Thermal impedance (Junction to Case)

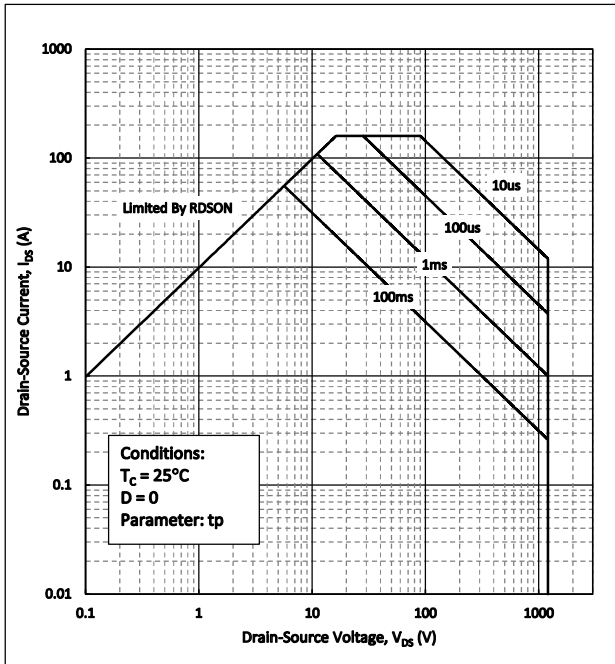

Figure 19. Safe Operating Area

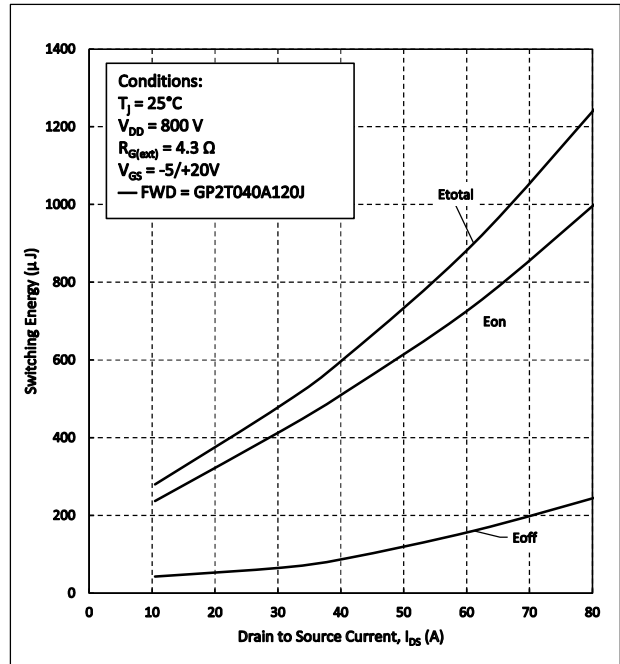

Figure 20. Clamped Inductive Switching Energy vs. Drain Current

# 1200V SiC MOSFET

# GP2T040A120J

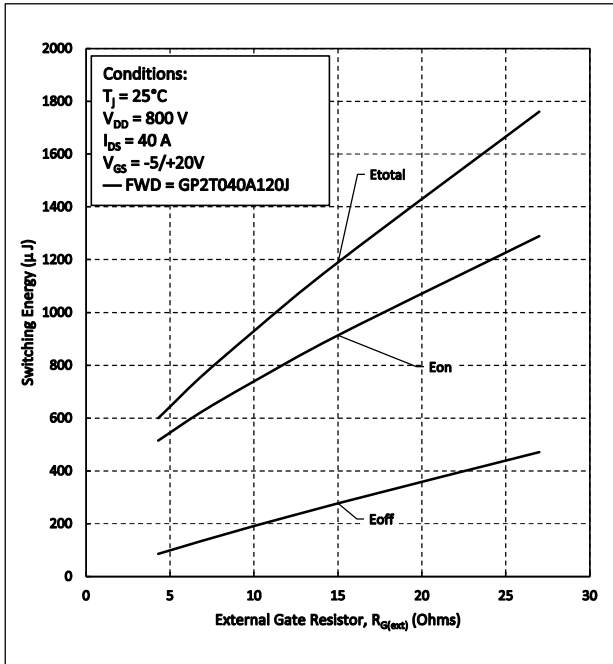

Figure 21. Clamped Inductive Switching Energy vs.  $R_{G(\text{ext})}$

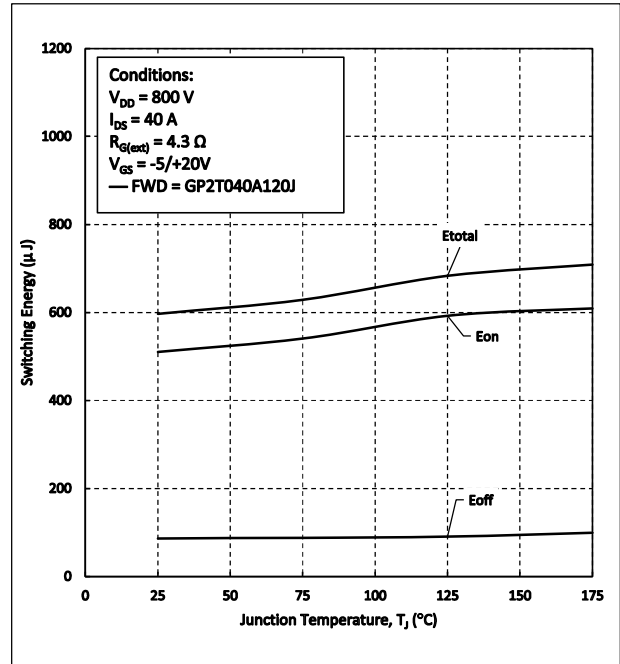

Figure 22. Clamped Inductive Switching Energy vs. Temperature

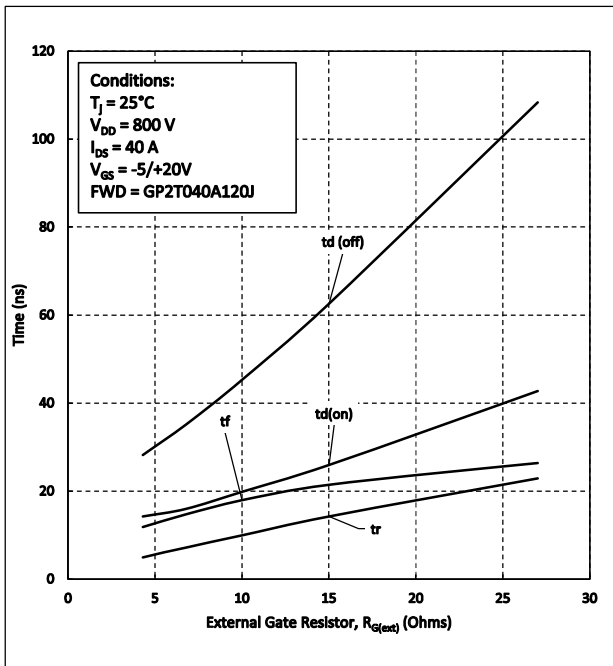

Figure 23. Switching Times vs  $R_{G(\text{ext})}$

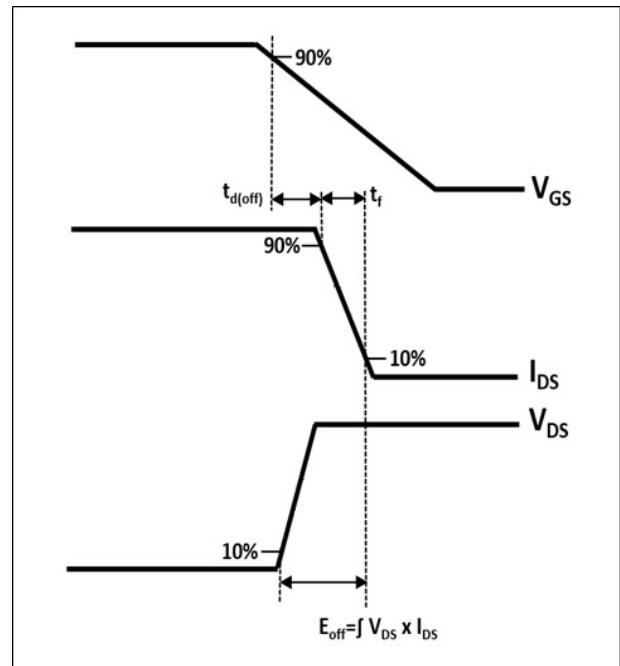

Figure 24. Turn-off Transient Definitions



# 1200V SiC MOSFET

# GP2T040A120J

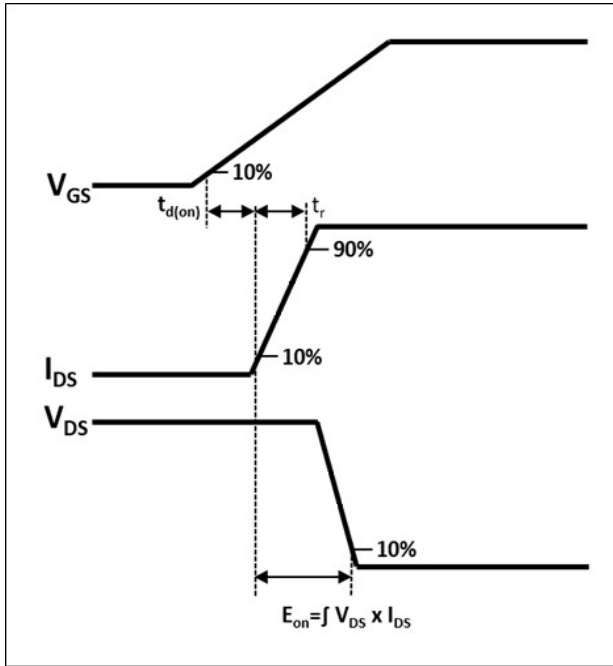

Figure 25. Turn-on Transient Definitions

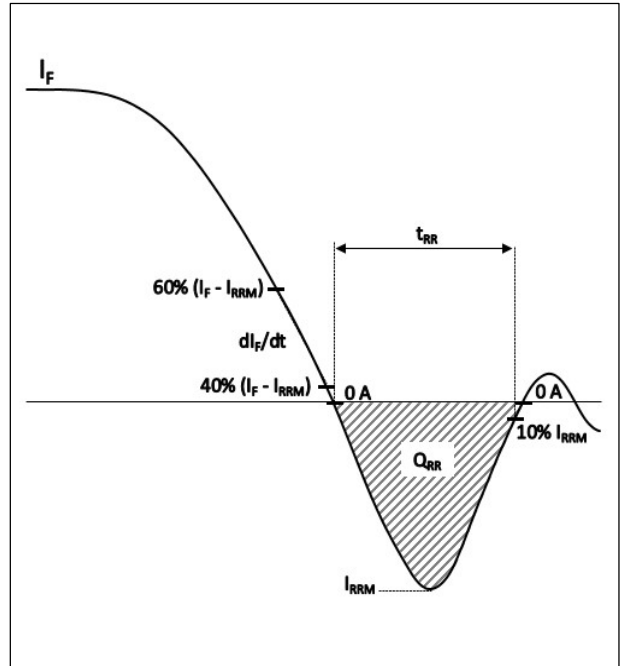
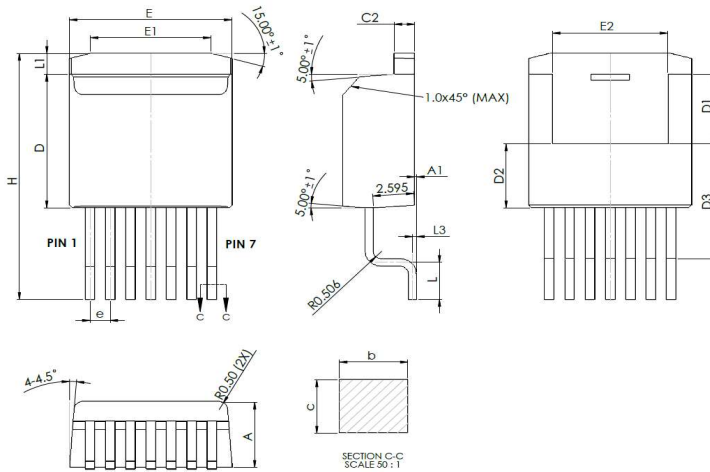

Figure 26. Reverse Recovery Definitions

## Package Dimensions TO-263-7L



Sym	Millimeters		Inches	
	Min	Max	Min	Max
A	4.30	4.57	0.169	0.180
A1	0.00	0.25	0.000	0.010
b	0.50	0.70	0.020	0.028
c	0.33	0.65	0.013	0.026
C2	1.17	1.40	0.046	0.055
D	9.03	9.13	0.355	0.359
D1	4.66	4.81	0.183	0.189
D2	4.255 BSC		0.168 BSC	
D3	7.170 BSC		0.282 BSC	
E	10.13	10.23	0.399	0.403
E1	6.50	8.60	0.256	0.339
E2	6.78	7.67	0.267	0.302
e	1.22	1.32	0.048	0.052
H	15.04	17.12	0.592	0.674
L3	0.254 BSC		0.010 BSC	

## Recommended Minimum Pad Dimensions

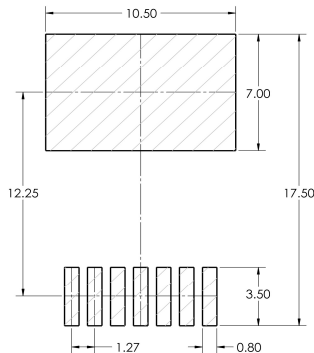

## **Notes**

### **RoHS Compliance**

The levels of RoHS restricted materials in this product are below the maximum concentration values (also referred to as the threshold limits) permitted for such substances, or are used in an exempted application, in accordance with EU Directive 2011/65/EC (RoHS2), as implemented March, 2013. RoHS Declarations for this product can be obtained from the Product Documentation sections of [www.SemiQ.com](http://www.SemiQ.com).

### **REACH Compliance**

REACH substances of high concern (SVHC) information is available for this product. Since the European Chemicals Agency (ECHA) has published notice of their intent to frequently revise the SVHC listing for the foreseeable future, please contact our office at SemiQ Headquarters in Lake Forest, California to insure you get the most up-to-date REACH SVHC Declaration. REACH banned substance information (REACH Article 67) is also available upon request.

SemiQ Inc., reserves the right to make changes to the product specifications and data in this document without notice. SemiQ products are sold pursuant to SemiQ's terms and conditions of sale in place at the time of order acknowledgement.

This product has not been designed or tested for use in, and is not intended for use in, applications implanted into the human body nor in applications in which failure of the product could lead to death, personal injury or property damage, including but not limited to equipment used in the operation of nuclear facilities, life-support machines, cardiac defibrillators or similar emergency medical equipment, aircraft navigation or communication or control systems, or air traffic control.

SemiQ makes no warranty, representation or guarantee regarding the suitability of its products for any particular purpose, nor does SemiQ assume any liability arising out of the application or use of any product or circuit, and specifically disclaims any and all liability, including without limitation special, consequential or incidental damages. Buyer is responsible for its products and applications using SemiQ products.

To obtain additional technical information or to place an order for this product, please contact us. The information in this datasheet is provided by SemiQ. SemiQ reserves the right to make changes, corrections, modifications, and improvements of datasheet without notice.

## X-ON Electronics

Largest Supplier of Electrical and Electronic Components

*Click to view similar products for [SiC MOSFETs](#) category:*

*Click to view products by [SemiQ](#) manufacturer:*

Other Similar products are found below :

[NTC040N120SC1](#) [HC3M001K170J](#) [IMBG65R048M1HXTMA1](#) [IMW120R045M1](#) [SCT3080ALGC11](#) [C3M0120100K](#) [C2M1000170J](#)  
[C3M0120090J](#) [C3M0065090J](#) [C3M0280090J](#) [SCT2750NYTB](#) [SCT2H12NYTB](#) [C3M0021120D](#) [C3M0016120K](#) [C3M0045065D](#)  
[C3M0045065K](#) [E3M0120090J](#) [C3M0065090J-TR](#) [C3M0120100J](#) [C3M0075120J](#) [DMWS120H100SM4](#) [DMWSH120H28SM4](#)  
[DMWSH120H90SM4](#) [DMWSH120H90SM4Q](#) [DMWSH120H28SM4Q](#) [DMWSH120H90SCT7Q](#) [DMWSH120H28SM3](#)  
[DMWSH120H43SM3](#) [DMWSH120H90SM3](#) [DMWSH120H28SM3Q](#) [DMWSH120H90SM3Q](#) [DIF120SIC053-AQ](#) [DIW120SIC059-AQ](#)  
[G2R1000MT17D](#) [G3R60MT07K](#) [G2R50MT33K](#) [G3R12MT12K](#) [G3R160MT12D](#) [G3R160MT12J-TR](#) [G3R160MT17D](#) [G3R160MT17J-TR](#)  
[G3R20MT12K](#) [G3R20MT12N](#) [G3R20MT17K](#) [G3R20MT17N](#) [G3R30MT12J-TR](#) [G3R30MT12K](#) [G3R350MT12D](#) [G3R40MT12D](#)  
[G3R40MT12J](#)