

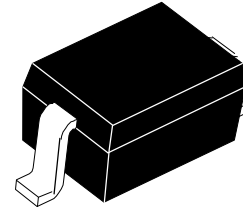
## Features

- 350W peak pulse power ( $t_p = 8/20\mu s$ )
- SOD-323 package
- Fast response time, typically  $< 1\text{ ns}$
- Excellent clamping voltage
- Low leakage current
- IEC 61000-4-2  $\pm 15\text{ kV}$  (Air) ESD protection
- IEC 61000-4-2  $\pm 8\text{ kV}$  (Contact) ESD protection
- IEC 61000-4-4 40A (5/50ns) EFT protection
- RoHS compliant

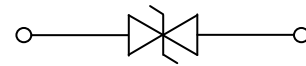
## Applications

- Laptop computers
- Cellular phones
- Digital cameras
- PDAs

## SES5VD323-2B



**SOD-323**



**Schematic Diagram**

## Absolute Maximum Ratings

( $T_A = 25^\circ\text{C}$ , Unless otherwise specified.)

Rating	Symbols	Value	Units
Peak Pulse Power ( $T_P = 8/20\mu s$ )	$P_{PP}$	350	W
Peak Pulse Current ( $T_P = 8/20\mu s$ )	$I_{PP}$	13.5	A
Operating Temperature	$T_J$	-55 to +150	$^\circ\text{C}$
Storage temperature	$T_{STG}$	-55 to +150	$^\circ\text{C}$

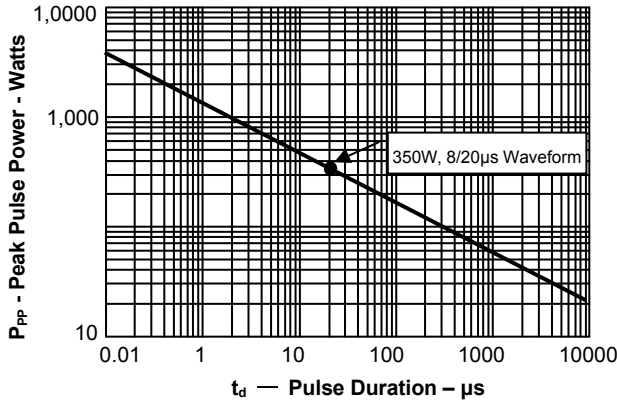
## Electrical Characteristics

( $T_A = 25^\circ\text{C}$ , Unless otherwise specified.)

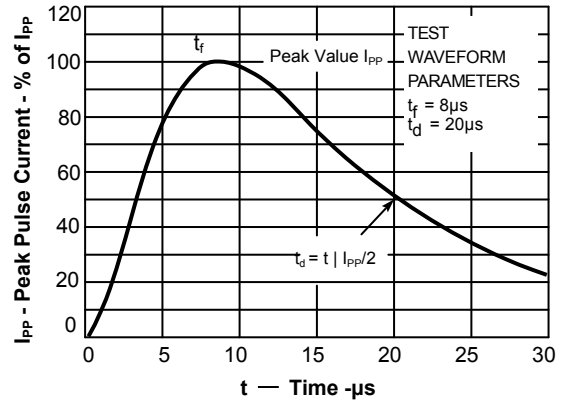
Parameter	Symbols	Conditions	Min	Typ	Max	Units
Reverse stand-off voltage	$V_{RWM}$				5	V
Reverse Breakdown Voltage	$V_{BR}$	$I_T = 1\text{ mA}$	6		7.8	V
Reverse Leakage Current	$I_R$	$V_{RWM} = 5\text{ V}$			1	$\mu\text{A}$
Clamping Voltage	$V_C$	$I_{PP} = 1\text{ A}$ , $T_P = 8/20\mu s$			9.8	V
Clamping Voltage	$V_C$	$I_{PP} = 9.8\text{ A}$ , $T_P = 8/20\mu s$		17		V
Clamping Voltage	$V_C$	$I_{PP} = 13.5\text{ A}$ , $T_P = 8/20\mu s$		25		V
Junction Capacitance	$C_J$	$V_R = 0\text{ V}$ , $f = 1\text{ MHz}$		25		pF

## Typical Characteristic Curves

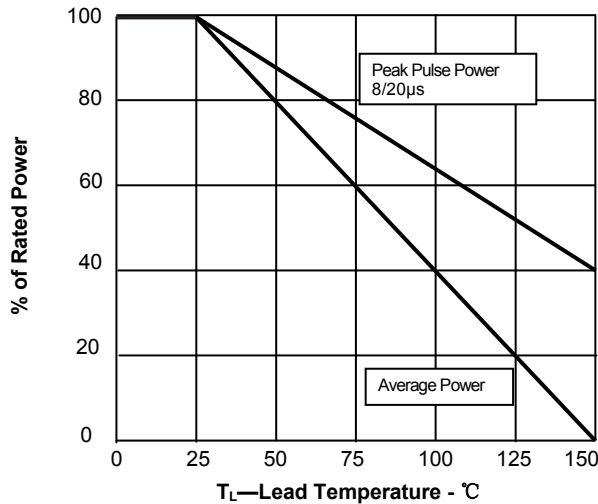
**Fig.1 Peak Pulse Power vs Pulse Time**



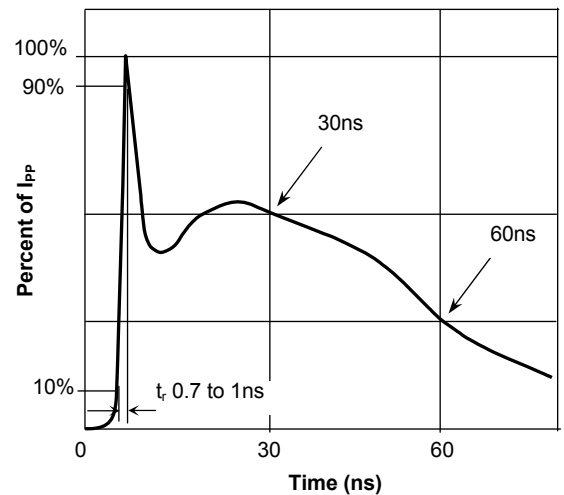
**Fig.2 Pulse WaveForm-8/20μs**



**Fig.3 Power Derating Curve**

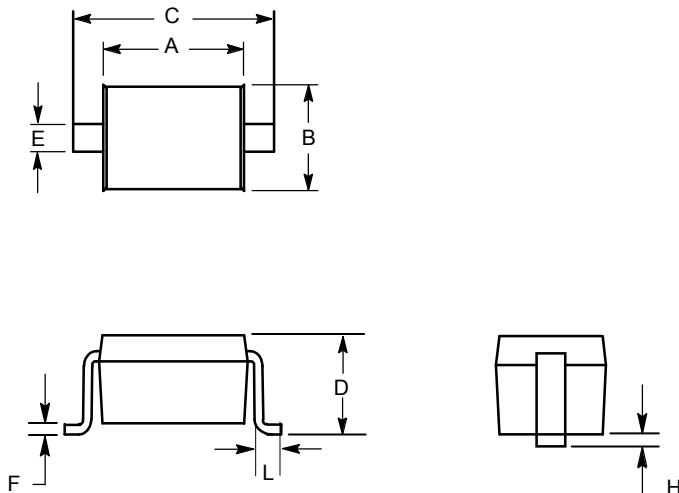


**Fig.4 Pulse Waveform-ESD(IEC61000-4-2)**



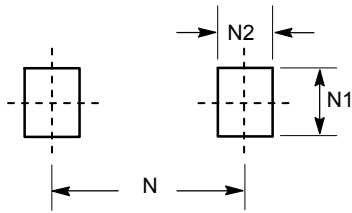
ESD Protection Diode

## Product Dimensions



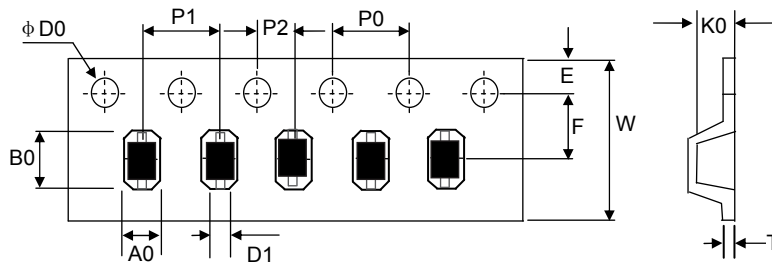
Dim	millimeters	
	min	max
A	1.60	1.90
B	1.15	1.45
C	2.39	2.70
D	0.80	1.10
E	0.25	0.40
F	0.10	0.20
H		0.10
L	0.20	-

### PAD Dimensions



Dim	millimeters
N1	0.80
N2	0.80
N	3.00

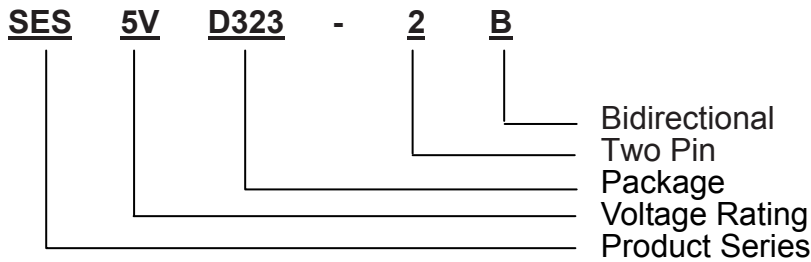
### Package Information



Unit:mm

A0	B0	K0	D1	$\phi$ D0	E	F	W	P0	P1	P2	T
1.52±0.10	2.90±0.10	1.35±0.10	1.0±0.25	1.50±0.10	1.75± 0.10	3.50± 0.05	8.00± 0.10	4.00±0.10	4.00±0.10	2.00±0.05	0.24~0.27

### Part Number System



### Marking



### Order Information

Device	Package	Net Weight	Carrier	Quantity	HSF Status
SES5VD323-2B	SOD-323	0.0045g	Tape & Reel	3000pcs	RoHS compliant

## Revision History


Date	Revision	Description of changes
8-October-2011	A0	First issue
12-December-2012	A1	Modify
24-March-2014	A2	Add Ipp
27-June-2014	A3	Update Cj

**CAUTION / WARNING**

- Information in this document is believed to be accurate and reliable. However, SEMITEL does not give any representations or warranties, expressed or implied, as to the accuracy or completeness of such information and shall have no liability for the consequences of use of such information.
- Users should independently evaluate the suitability of and test each product selected for their own applications, and SEMITEL assumes no liability whatsoever relating to the choice, selection or use of the SEMITEL products and services described herein.
- SEMITEL reserves the right to change or update, without notice, any information contained in this publication; to change, without notice, the design, construction, processing, or specification of any product; and to discontinue or limit production or distribution of any product.
- Information in this document supersedes and replaces all information previously supplied.
- Products are not designed, authorized or warranted to be suitable for use in medical, military, aircraft, space or life support equipment, nor in applications where failure or malfunction of an SEMITEL product can reasonably be expected to result in personal injury, death or severe property or environmental damage. SEMITEL accepts no liability for inclusion and/or use of SEMITEL products in such equipment or applications and therefore such inclusion and/or use is at the customer's own risk.
- This document as well as the item(s) described herein may be subject to export control regulations. Export might require a prior authorization from national authorities.
- Resale of SEMITEL products with provisions different from the statements and/or technical features set forth in this document shall immediately void any warranty granted by SEMITEL for the SEMITEL product or service described herein and shall not create or extend in any manner whatsoever, any liability of SEMITEL.
- SEMITEL expressly disclaims all implied warranties regarding the information contained herein, including, but not limited to, any implied warranties of merchantability or fitness for a particular purpose. SEMITEL only obligations are those in the SEMITEL Standard Terms and Conditions of Sale and in no case will SEMITEL be liable for any incidental, indirect, or consequential damages arising from the sale, resale, use, or misuse of its products.

Specifications are subject to change without notice

© Copyright 2005, Semitel Electronics

 .® is a registered trademark of Semitel Electronics

All rights reserved

## X-ON Electronics

Largest Supplier of Electrical and Electronic Components

*Click to view similar products for [ESD Suppressors / TVS Diodes](#) category:*

*Click to view products by [Semitel](#) manufacturer:*

Other Similar products are found below :

[60KS200C](#) [D18V0L1B2LP-7B](#) [D5V0F4U5P5-7](#) [DESD5V0U1BB-7](#) [NTE4902](#) [P4KE27CA](#) [P6KE11CA](#) [P6KE39CA-TP](#) [P6KE8.2A](#)  
[SA110CA](#) [SA60CA](#) [SA64CA](#) [SMBJ12CATR](#) [SMBJ33CATR](#) [SMBJ8.0A](#) [ESD101-B1-02ELS E6327](#) [ESD105-B1-02EL E6327](#) [ESD112-B1-02EL E6327](#) [ESD119B1W01005E6327XTSA1](#) [ESD5V0L1B02VH6327XTSA1](#) [ESD7451N2T5G](#) [19180-510](#) [CPDT-5V0USP-HF](#)  
[3.0SMCJ33CA-F](#) [3.0SMCJ36A-F](#) [HSPC16701B02TP](#) [D3V3Q1B2DLP3-7](#) [D55V0M1B2WS-7](#) [DESD5V0U1BL-7B](#) [DRTR5V0U4SL-7](#)  
[SCM1293A-04SO](#) [ESD200-B1-CSP0201 E6327](#) [SM12-7](#) [SMLJ45CA-TP](#) [CEN955 W/DATA](#) [82350120560](#) [VESD12A1A-HD1-GS08](#)  
[CPDUR5V0R-HF](#) [CPDQC5V0U-HF](#) [CPDQC5V0USP-HF](#) [CPDQC5V0-HF](#) [D1213A-01LP4-7B](#) [D1213A-02WL-7](#) [MMAD1108/TR13](#)  
[5KP100A](#) [5KP15A](#) [5KP18A](#) [5KP48A](#) [5KP90A](#) [5KP90CA](#)