

# BAS70WS

## Small Signal Schottky Barrier Diode

### Features

- Low forward voltage drop

### PINNING

PIN	DESCRIPTION
1	Cathode
2	Anode

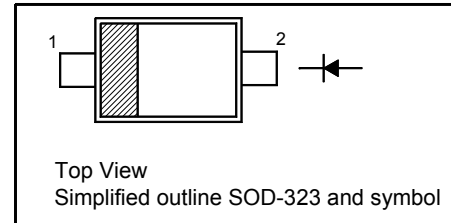

### Absolute Maximum Ratings ( $T_a = 25^\circ\text{C}$ )

Parameter	Symbol	Value	Unit
Repetitive Peak Reverse Voltage	$V_{RRM}$	70	V
Average Rectified Forward Current	$I_{F(AV)}$	70	mA
Surge Non-Repetitive Forward Current ( $t_p = 10$ ms)	$I_{FSM}$	1	A
Total Power Dissipation	$P_{tot}$	230	mW
Junction Temperature	$T_J$	150	$^\circ\text{C}$
Storage Temperature Range	$T_{stg}$	- 65 to + 150	$^\circ\text{C}$

### Thermal Characteristics

Parameter	Symbol	Value	Unit
Typical Thermal Resistance from Junction to Ambient <sup>1)</sup>	$R_{\theta JA}$	550	$^\circ\text{C/W}$

<sup>1)</sup> Device mounted on FR-4 substrate PC board, 2oz copper, with minimum recommended pad layout.

### Characteristics at $T_a = 25^\circ\text{C}$

Parameter	Symbol	Min.	Max.	Unit
Reverse Breakdown Voltage at $I_R = 10$ $\mu\text{A}$	$V_{(BR)R}$	70	-	V
Forward Voltage at $I_F = 1$ mA	$V_F$	-	410	mV
Reverse Current at $V_R = 50$ V	$I_R$	-	100	nA
Diode Capacitance at $V_R = 0$ V, $f = 1$ MHz	$C_{tot}$	-	2	pF

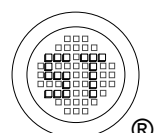

## Electrical Characteristic Curves

Fig 1. Reverse Characteristic Curve

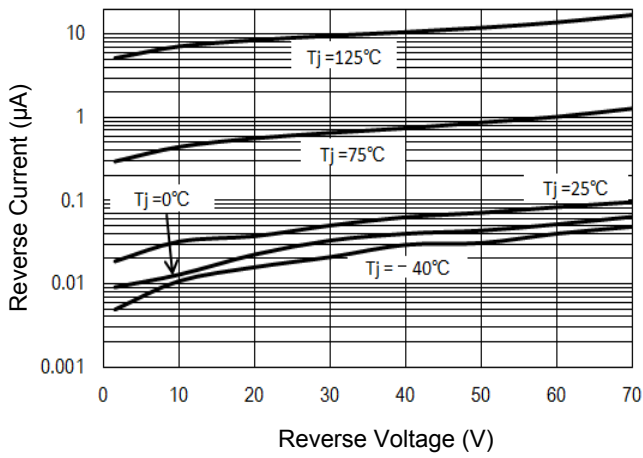

Fig 2. Forward Characteristic Curve

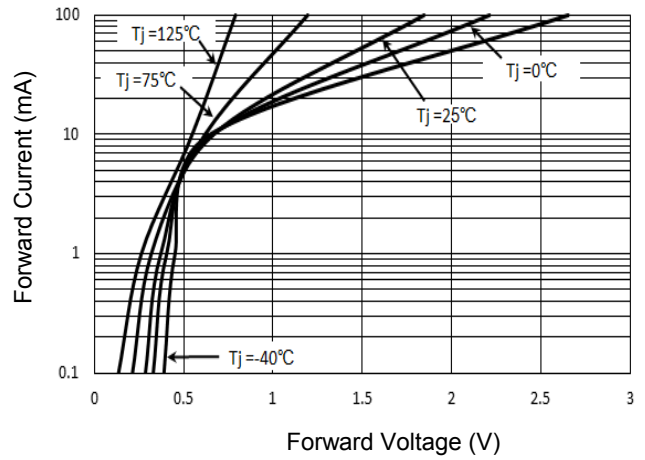

Fig 3. Junction Capacitance

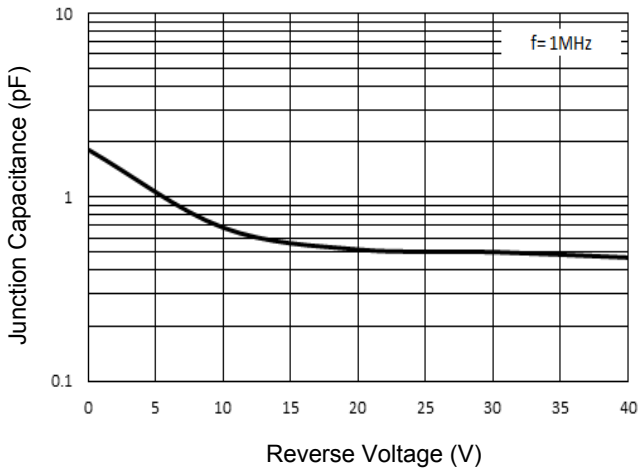
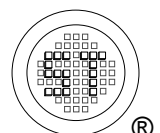
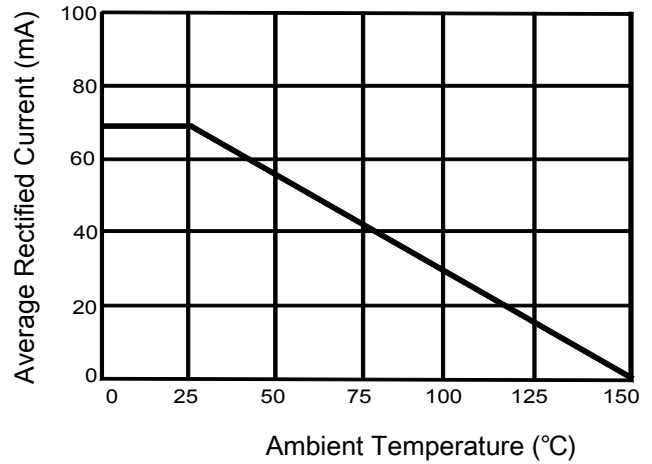

Fig 4. Average Rectified Current Derating Curve



# BAS70WS

## PACKAGE OUTLINE

Plastic surface mounted package; 2 leads

SOD-323

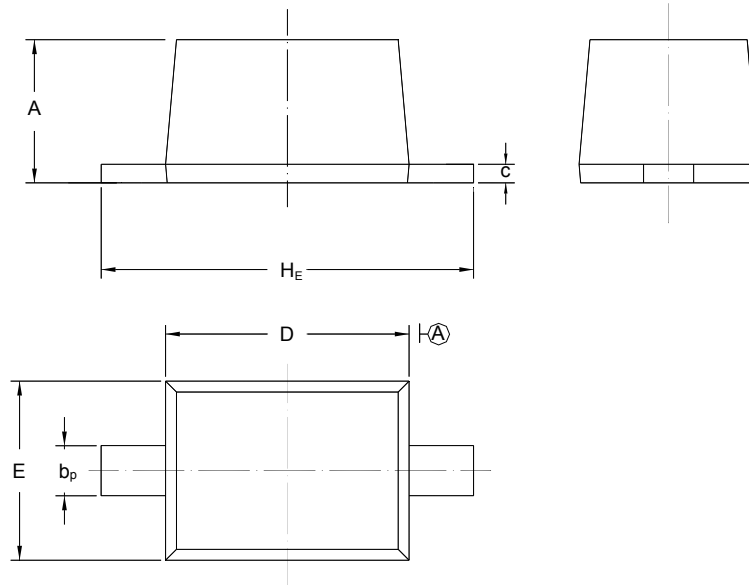

UNIT	A	b <sub>p</sub>	C	D	E	H <sub>E</sub>
mm	1.10 0.80	0.40 0.25	0.15 0.10	1.80 1.60	1.35 1.15	2.80 2.30

## Recommended Soldering Footprint

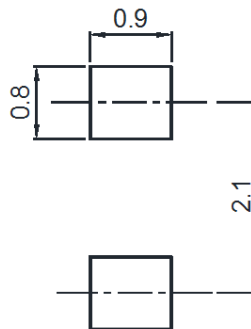

## Packing information

Package	Tape Width (mm)	Pitch		Reel Size		Per Reel Packing Quantity
		mm	inch	mm	inch	
SOD-323	8	4 ± 0.1	0.157 ± 0.004	178	7	3,000

## Marking information

" SX " = Part No.

" III " = Cathode line

Font type: Arial

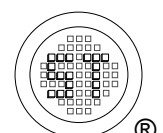
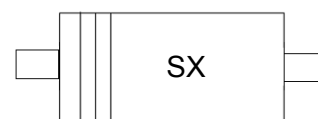

## X-ON Electronics

Largest Supplier of Electrical and Electronic Components

*Click to view similar products for [Schottky Diodes & Rectifiers](#) category:*

*Click to view products by [Semtech](#) manufacturer:*

Other Similar products are found below :

[MA4E2039](#) [MA4E2508M-1112](#) [MBR1545CT](#) [MMBD301M3T5G](#) [RB160M-50TR](#) [D83C](#) [BAS16E6433HTMA1](#) [BAT 54-02LRH E6327](#)  
[NRVBAF360T3G](#) [NSR05F40QNXT5G](#) [NTE555](#) [JANS1N6640](#) [SK310-T](#) [SK34B-TP](#) [SS3003CH-TL-E](#) [GA01SHT18](#)  
[CRS10I30A\(TE85L,QM](#) [MA4E2501L-1290](#) [MBRA140TRPBF](#) [MBRB30H30CT-1G](#) [BAT 15-04R E6152](#) [JANTX1N5712-1](#) [DMJ3940-000](#)  
[SB007-03C-TB-E](#) [SK33B-TP](#) [NRVBB20100CTT4G](#) [NRVBM120LT1G](#) [NTSB30U100CT-1G](#) [VS-6CWQ10FNHM3](#) [CRG04\(T5L,TEMQ\)](#)  
[ACDBA1100LR-HF](#) [ACDBA1200-HF](#) [ACDBA240-HF](#) [ACDBA3100-HF](#) [CDBQC0530L-HF](#) [CDBQC0240LR-HF](#) [ACDBA260LR-HF](#)  
[ACDBA1100-HF](#) [MA4E2502L-1246](#) [10BQ015-M3/5BT](#) [NRVBM120ET1G](#) [CRS08TE85LQM](#) [PMAD1108-LF](#) [B120Q-13-F](#) [1N5819T-G](#)  
[B0530WSQ-7-F](#) [PDS1040Q-13](#) [B160BQ-13-F](#) [SDM05U20CSP-7](#) [B140S1F-7](#)