

BCX53U-HAF

PNP Silicon Epitaxial Planar Transistor

Medium Power Transistor

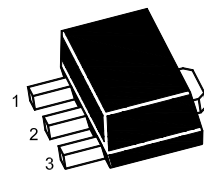

1.Base 2.Collector 3.Emitter
SOT-89 Plastic Package

Absolute Maximum Ratings ($T_a = 25^\circ\text{C}$)

Parameter	Symbol	Value	Unit
Collector Base Voltage	$-V_{\text{CBO}}$	100	V
Collector Emitter Voltage	$-V_{\text{CEO}}$	80	V
Emitter Base Voltage	$-V_{\text{EBO}}$	5	V
Collector Current	$-I_{\text{C}}$	1	A
Peak Collector Current	$-I_{\text{CM}}$	2	A
Total Power Dissipation	P_{tot}	0.5 ¹⁾ 1.3 ²⁾	W
Junction Temperature	T_{j}	150	°C
Storage Temperature Range	T_{stg}	- 65 to + 150	°C

¹⁾ Device mounted on an FR4 Printed-Circuit Board(PCB), single-sided copper, tin-plated and standard footprint.

²⁾ Device mounted on an FR4 PCB, single-sided copper, tin-plated, mounting pad for collector 6 cm²

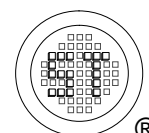

BCX53U-HAF

Characteristics at $T_a = 25^\circ\text{C}$

Parameter	Symbol	Min.	Typ.	Max.	Unit
DC Current Gain at $-V_{CE} = 2\text{ V}$, $-I_C = 5\text{ mA}$ at $-V_{CE} = 2\text{ V}$, $-I_C = 150\text{ mA}$ at $-V_{CE} = 2\text{ V}$, $-I_C = 500\text{ mA}$	h_{FE} h_{FE} h_{FE} h_{FE}	40 63 100 25	- - - -	- 160 250 -	- - - -
Collector Base Cutoff Current at $-V_{CB} = 64\text{ V}$,	$-I_{CBO}$	-	-	100	nA
Emitter Base Cutoff Current at $-V_{EB} = 5\text{ V}$	$-I_{EBO}$	-	-	100	nA
Collector Cutoff Current at $-V_{CE} = 64\text{ V}$, $I_B = 0$, $T_a = 65^\circ\text{C}$, 90%RH	$-I_{CEO}$	-	-	1	μA
Collector Base Breakdown Voltage at $-I_C = 100\text{ }\mu\text{A}$	$-V_{(BR)CBO}$	100	-	-	V
Collector Emitter Breakdown Voltage at $-I_C = 1\text{ mA}$	$-V_{(BR)CEO}$	80	-	-	V
Emitter Base Breakdown Voltage at $-I_E = 100\text{ }\mu\text{A}$	$-V_{(BR)EBO}$	5	-	-	V
Collector Emitter Saturation Voltage at $-I_C = 500\text{ mA}$, $-I_B = 50\text{ mA}$	$-V_{CE(sat)}$	-	-	0.5	V
Base Emitter Voltage at $-V_{CE} = 2\text{ V}$, $-I_C = 500\text{ mA}$	$-V_{BE}$	-	-	1	V
Transition Frequency at $-V_{CE} = 5\text{ V}$, $-I_C = 50\text{ mA}$, $f = 100\text{ MHz}$	f_T	-	145	-	MHz
Collector Capacitance at $-V_{CB} = 15\text{ V}$, $f = 1\text{ MHz}$	C_c	-	15	-	pF

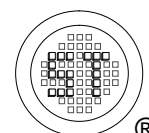

BCX53U-HAF

Electrical Characteristics Curves

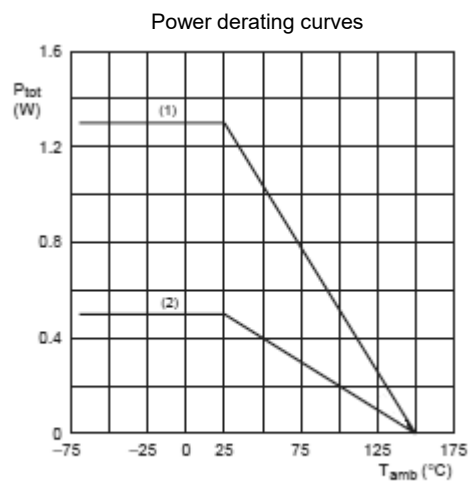
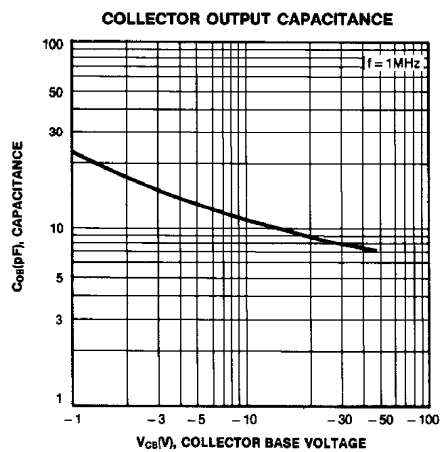
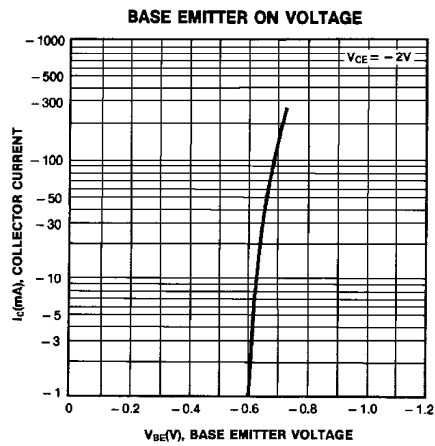
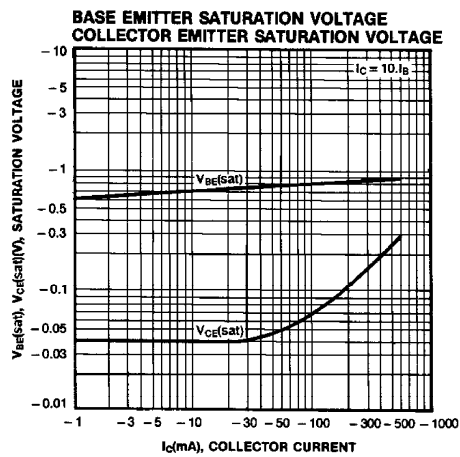
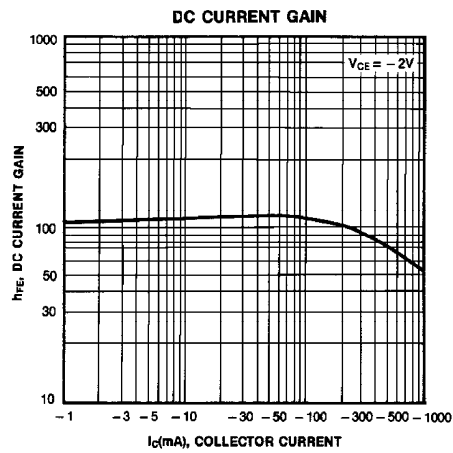
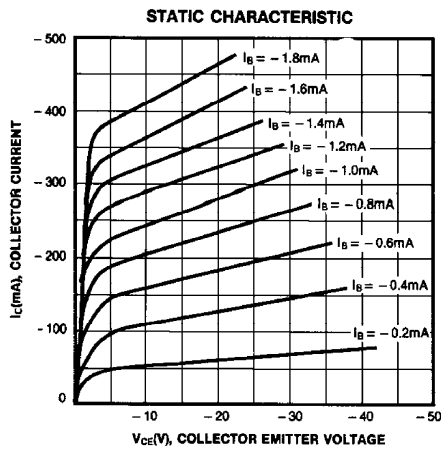

- (1) FR4 PCB, mounting pad for collector 6 cm²
- (2) FR4 PCB, standard footprint

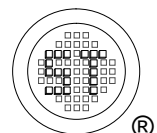

BCX53U-HAF

Package Outline (Dimensions in mm)

SOT-89

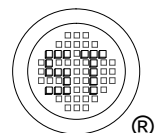
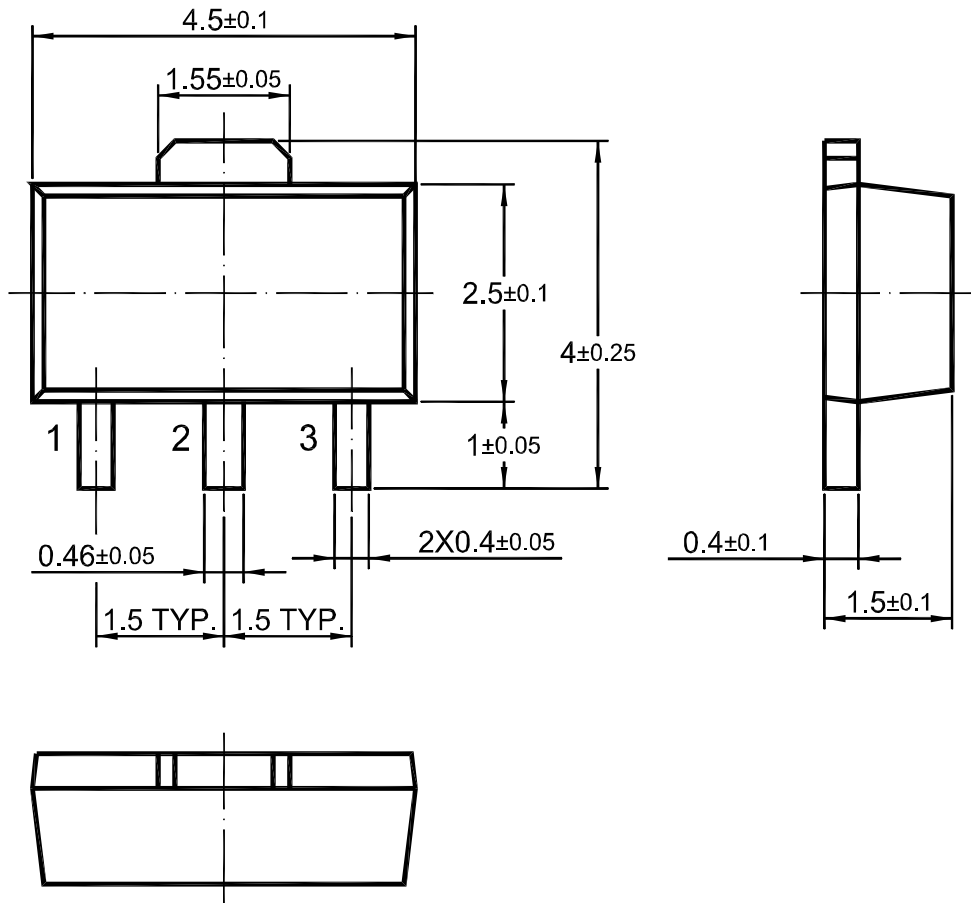

X-ON Electronics

Largest Supplier of Electrical and Electronic Components

Click to view similar products for [Schottky Diodes & Rectifiers](#) category:

Click to view products by [Semtech](#) manufacturer:

Other Similar products are found below :

[MA4E2039](#) [MA4E2508M-1112](#) [MBR1545CT](#) [MMBD301M3T5G](#) [RB160M-50TR](#) [D83C](#) [BAS16E6433HTMA1](#) [BAT 54-02LRH E6327](#)
[NRVBAF360T3G](#) [NSR05F40QNXT5G](#) [NTE555](#) [JANS1N6640](#) [SK310-T](#) [SK34B-TP](#) [SS3003CH-TL-E](#) [GA01SHT18](#)
[CRS10I30A\(TE85L,QM](#) [MA4E2501L-1290](#) [MBRA140TRPBF](#) [MBRB30H30CT-1G](#) [BAT 15-04R E6152](#) [JANTX1N5712-1](#) [DMJ3940-000](#)
[SB007-03C-TB-E](#) [SK33B-TP](#) [NRVBB20100CTT4G](#) [NRVBM120LT1G](#) [NTSB30U100CT-1G](#) [VS-6CWQ10FNHM3](#) [CRG04\(T5L,TEMQ\)](#)
[ACDBA1100LR-HF](#) [ACDBA1200-HF](#) [ACDBA240-HF](#) [ACDBA3100-HF](#) [CDBQC0530L-HF](#) [CDBQC0240LR-HF](#) [ACDBA260LR-HF](#)
[ACDBA1100-HF](#) [MA4E2502L-1246](#) [10BQ015-M3/5BT](#) [NRVBM120ET1G](#) [CRS08TE85LQM](#) [PMAD1108-LF](#) [B120Q-13-F](#) [1N5819T-G](#)
[B0530WSQ-7-F](#) [PDS1040Q-13](#) [B160BQ-13-F](#) [SDM05U20CSP-7](#) [B140S1F-7](#)