

## Description

The EClamp2374KQ is a low pass filter array with integrated TVS diodes. It is designed to suppress unwanted EMI/RFI signals and provide electrostatic discharge (ESD) protection for Automotive grade electronics.

The device consists of four identical channels comprised of TVS diodes for ESD protection, and a resistor-capacitor network optimized for EMI/RFI filtering. A series resistor value of 100Ω and a capacitance value of 10pF are used to achieve 30dB minimum attenuation from 1.8GHz to 2.5GHz. The TVS diodes provide effective suppression of ESD voltages in excess of ±15kV (air discharge) and ±8kV (contact discharge) per IEC61000-4-2, level 4.

The EClamp2374KQ is packaged in an 8-pin, SLP1713P8 package. The package dimensions measure 1.7 x 1.3 x 0.5mm. The leads are spaced at a pitch of 0.4mm and are finished with a lead-free NiPdAu.

## Circuit Diagram (Each Line)

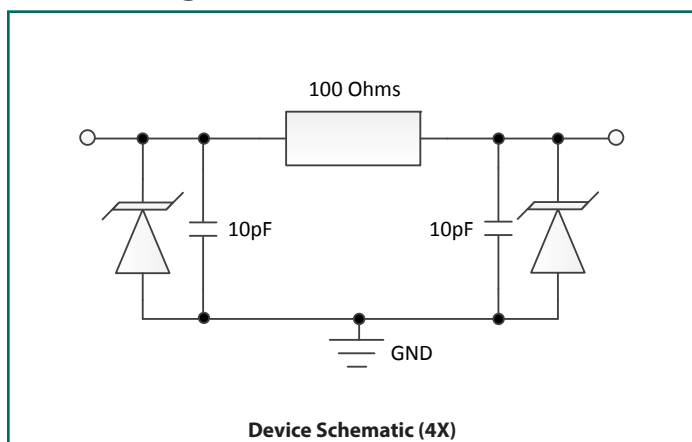

## Features

- Bidirectional EMI/RFI filter with integrated TVS for ESD protection
- Transient Protection to:
  - ♦ IEC 61000-4-2 (ESD) ±15kV (Air), ±8kV (Contact)
  - ♦ ISO-10605 (ESD) ±30kV (Air), ±30kV (Contact)
  - ♦ IEC 61000-4-4 (EFT) 4kV (5/50ns)
- Qualified to AEC-Q100, Grade 1
- Resistor: 100Ω ±15%
- Protection and filtering for four lines
- Filter performance: 30dB minimum attenuation 1.8GHz to 2.5GHz
- TVS Working Voltage: 5V
- Solid-state silicon-avalanche technology

## Mechanical Characteristics

- SLP1713P8 package
- Pb-Free, Halogen Free, RoHS/WEEE compliant
- Nominal Dimensions: 1.7 x 1.3 x 0.50 mm
- Lead Pitch: 0.4mm
- Lead Finish: NiPdAu
- Marking: Marking code
- Packaging: Tape and Reel

## Applications

- Automotive Color LCD
- Automotive Infotainment
- Color LCD Protection
- CCD Camera Lines

## Package Configuration

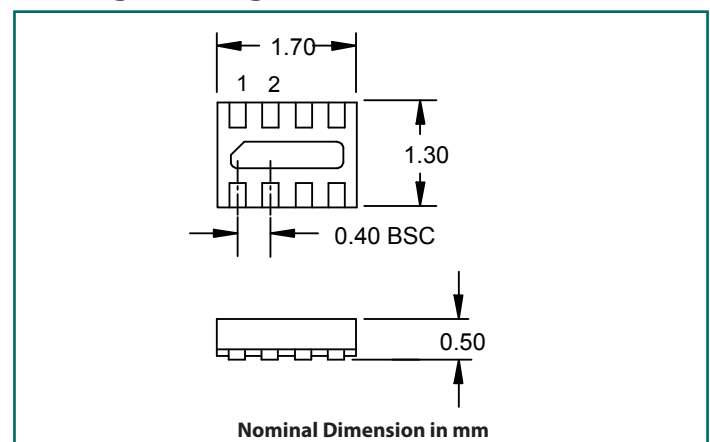

## Absolute Maximum Ratings

Rating	Symbol	Value	Units
ESD per IEC 61000-4-2 (Contact) <sup>(1)</sup> ESD per IEC 61000-4-2 (Air) <sup>(1)</sup>	$V_{ESD}$	$\pm 17$ $\pm 12$	kV
ESD per ISO-10605 (Contact) <sup>(2)</sup> ESD per ISO-10605 (Air) <sup>(2)</sup>	$V_{ESD}$	$\pm 17$ $\pm 12$	kV
Junction Temperature	$T_J$	125	°C
Operating Temperature	$T_J$	-40 to +125	°C
Storage Temperature	$T_{STG}$	-55 to +150	°C

## Electrical Characteristics (T=25°C unless otherwise specified)

EClamp2374KQ							
Parameter	Symbol	Conditions		Min.	Typ.	Max.	Units
Reverse Stand-Off Voltage	$V_{RWM}$					5	V
Reverse Breakdown Voltage	$V_{BR}$	$I_t = 1\text{mA}$ ,	-40°C to 125°C	6	8	10	V
Reverse Leakage Current	$I_R$	$V_{RWM} = 5\text{V}$	T = 25°C			0.50	μA
			T = 125°C		0.006	1	μA
Total Series Resistance	R	Each line		85	100	115	Ohms
Total Capacitance	$C_{in}$	Input to Gnd, Each line $V_R = 0\text{V}$ , f=1MHz	T = 25°C	16	20	24	pF
Total Capacitance	$C_{in}$	Input to Gnd, Each line $V_R = 2.5\text{V}$ , f=1MHz	T = 25°C	9	11	13	pF

Notes:

(1): ESD Gun return path to Ground Reference Plane (GRP)

(2): ESD Gun return path to Horizontal Coupling Plane (HCP); Test conditions: a) 150pF/330pF, 330Ω b) 150pF/330pF, 2kΩ

(3): Tested using a constant current source

(4): Transmission Line Pulse Test (TLP) Settings:  $t_p = 100\text{ns}$ ,  $t_r = 0.2\text{ns}$ ,  $I_{TLP}$  and  $V_{TLP}$  averaging window:  $t_1 = 70\text{ns}$  to  $t_2 = 90\text{ns}$ .

(5): Dynamic resistance calculated from  $I_{TLP} = 4\text{A}$  to  $I_{TLP} = 16\text{A}$

# Typical Characteristics

Typical Insertion Loss S21 (Each Line)

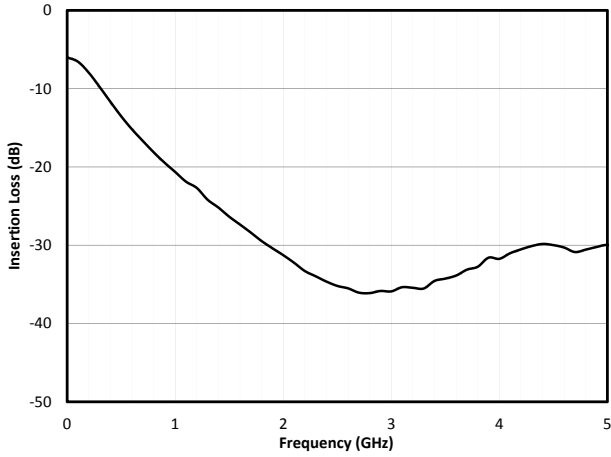

Analog Crosstalk (Each Line)

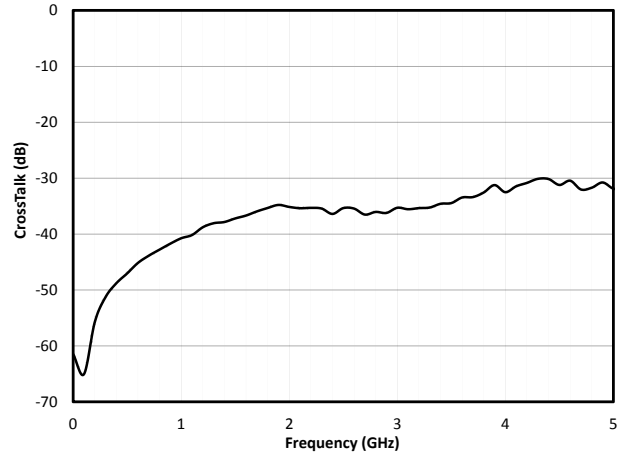

Capacitance vs. Reverse Voltage

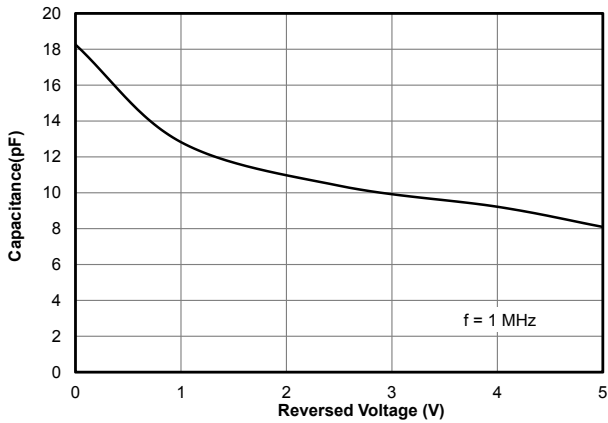

Capacitance vs. Temperature

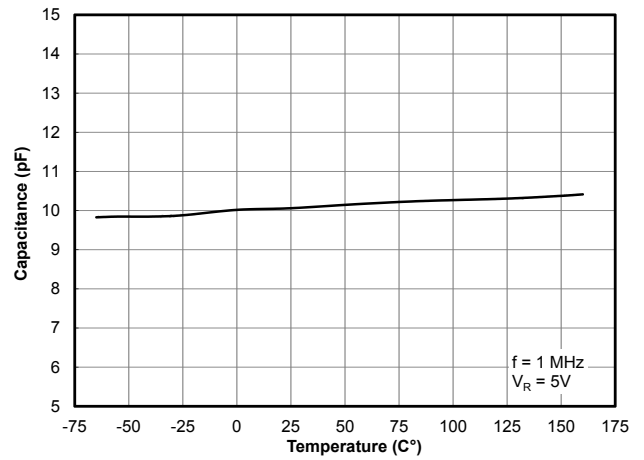

Series Resistance vs. Temperature

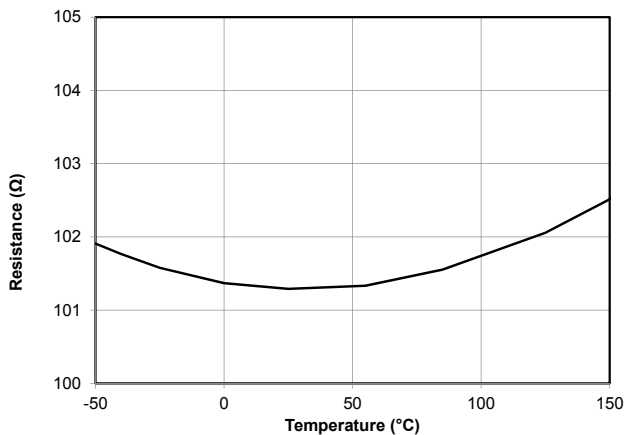

Reverse Breakdown Voltage vs. temperature

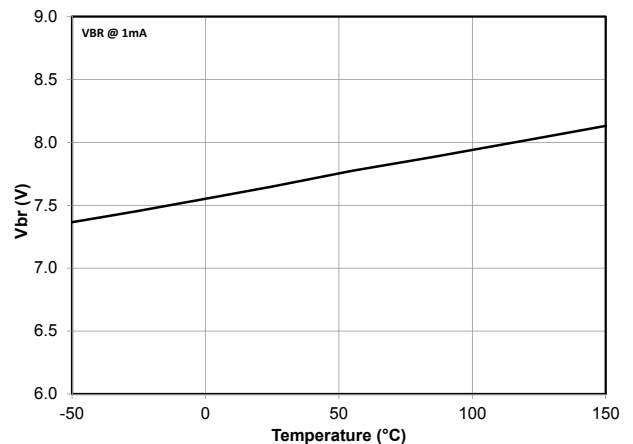

# Typical Characteristics

### ESD Clamping (8kV Contact per IEC 61000-4-2)

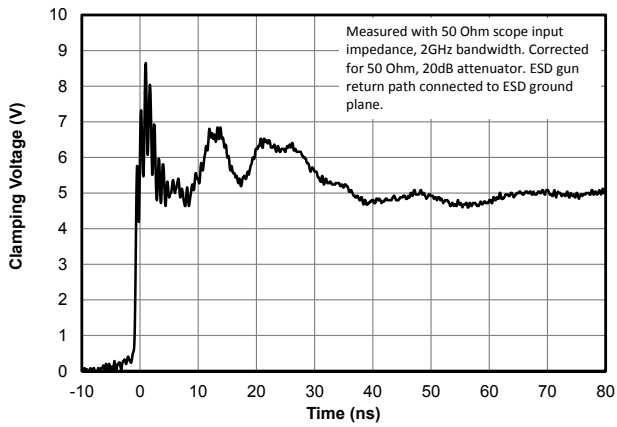

### ESD Clamping (-8kV Contact per IEC 61000-4-2)

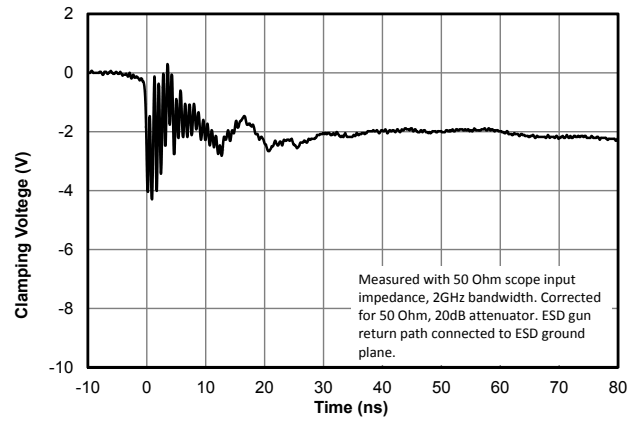

### ESD Clamping (+8kV Contact per ISO-10605 330pF, 330Ω)

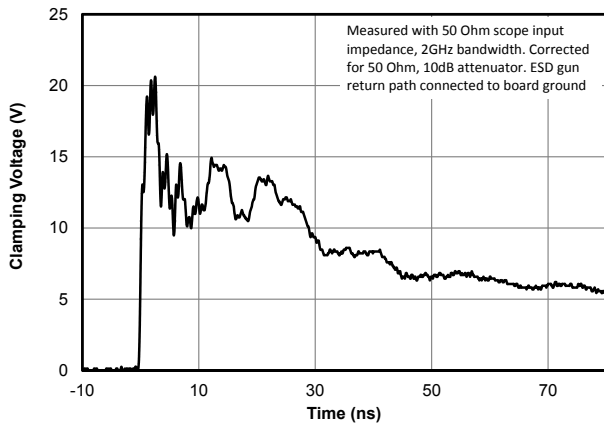

### ESD Clamping (-8kV Contact per ISO-10605 330pF, 330Ω)

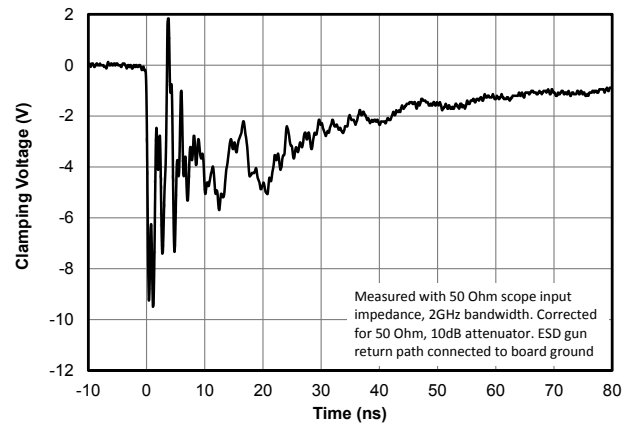

# Application Information

## Device Connection

The EClamp2374KQ is comprised of four identical circuits each consisting of a low pass filter for EMI/RFI suppression and dual TVS diodes for ESD protection. The device is in a 8-pin SLP package. Electrical connection is made to the 8 pins located at the bottom of the device. A center tab serves as the ground connection. The devices has a flow through design for easy layout. Pin connection are noted in Figure 1. All path lengths should be kept as short as possible to minimize the effects of parasitic inductance in the board traces. Recommendations for the ground connection are given below.

## Ground Connection Recommendations

Parasitic inductance present in the board layout will affect the filtering performance of the device. As frequency increases, the effect of the inductance becomes more dominant. This effect is given by Equation 1.

### Equation 1: The Impedance of an Inductor at Frequency XLF

$$X_{LF}(L, f) = 2 \cdot \pi \cdot f \cdot L$$

Where:

L = Inductance (H)

f = frequency (Hz)

Via connections to the ground plane form rectangular wire loops or ground loop inductance as shown in Figure 2. Ground loop inductance can be reduced by using multiple vias to make the connection to the ground plane. Bringing the ground plane closer to the signal layer (preferably to the next layer) also reduces ground loop inductance. Multiple vias in the device ground pad will result in a lower inductance ground loop over two exterior vias. Vias with a diameter *d* are separated by a distance *y* run between layers separated by a distance *x*. The inductance of the loop path is given by Equation 2. Thus, decreasing distance *x* and *y* will reduce the loop inductance and result in better high frequency filter characteristics.

**Figure 1: Pin Identification and Configuration (Top Side View)**

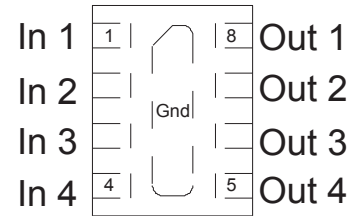

Pin	Identification
1 - 4	Input Lines
5 - 8	Output Lines
Center Tab	Ground

**Figure 2: Inductance of Rectangular Wire Loops**

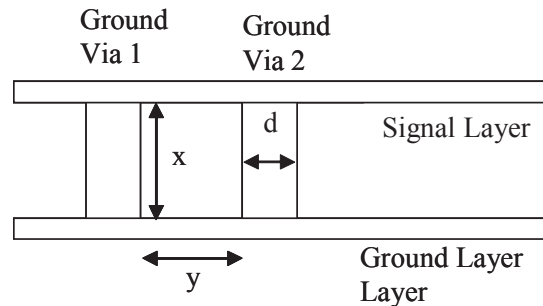

### Equation 2: Inductance of Rectangular Wire Loop

$$L_{RECT}(d, x, y) = 10.16 \cdot 10^{-9} \cdot \left\{ x \cdot \ln\left(\frac{2y}{d}\right) + y \cdot \ln\left(\frac{2x}{d}\right) \right\}$$

Where:

*d* = diameter of the wire (in)

*L* = Length of the wire loop (in)

*y* = Breadth of the wire loop (in)

## Application Information

Figure 3 shows the recommended device layout. The ground pad vias have a diameter of 0.008 inches (0.20 mm) while the two external vias have a diameter of 0.010 inches (0.250mm). The internal vias are spaced approximately evenly from the center of the pad. The designer may choose to use more vias with a smaller diameter (such as 0.005 inches or 0.125mm) since changing the diameter of the via will result in little change in inductance (i.e. the log function in Equation 2 in highly insensitive to parameter  $d$ ). Figure 4 shows a typical insertion loss ( $S_{21}$ ) plot for the device using Semtech’s filter evaluation board with 50 Ohm traces and the recommended via configuration. Figure 5 shows a typical insertion loss ( $S_{21}$ ) plot using a similar board without the internal ground pad vias. The result is a more inductive ground loop. Note the “hump” at a frequency of 2.5GHz. This is the resonant frequency of the higher ground loop inductance.

**Figure 3: Recommended Layout Using Ground Vias**

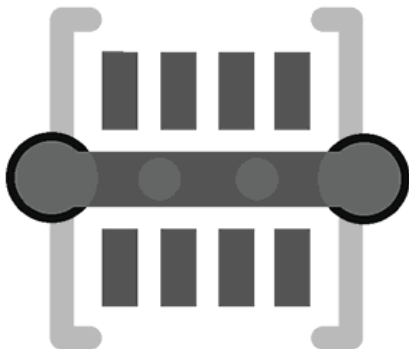

**Figure 4: Filter Characteristics Using Recommended Layout with Internal Vias**

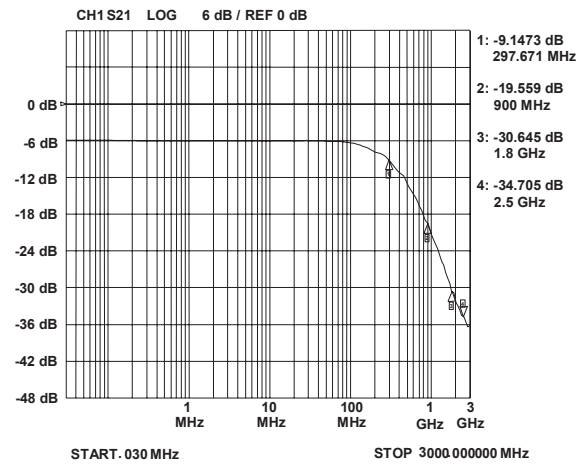

**Figure 5: Filter Characteristics Using Layout without Internal Ground Vias**

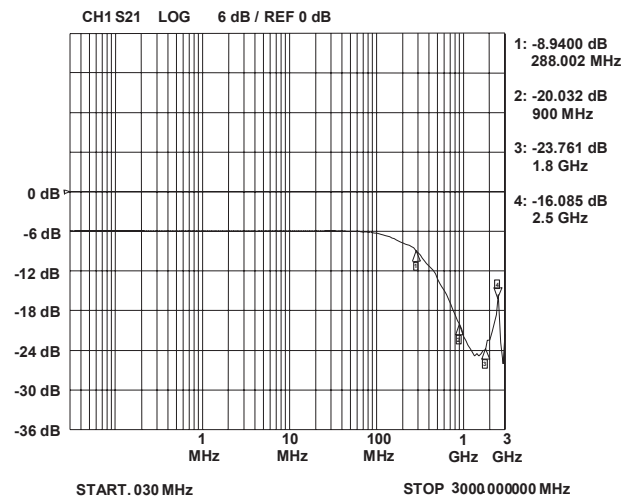

## Outline Drawing - SLP1713P8

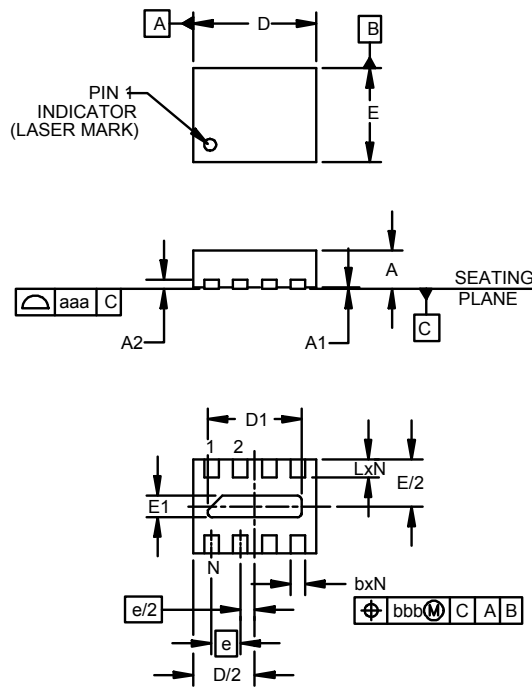

DIM	INCHES		MILLIMETERS			
	MIN	NOM	MAX	MIN	NOM	MAX
A	.018	.020	.022	0.45	0.50	0.55
A1	.000	.001	.002	0.00	0.02	0.05
A2		(.005)			(0.13)	
b	.006	.008	.010	0.15	0.20	0.25
D	.065	.067	.070	1.65	1.70	1.775
D1	.047	.051	.055	1.20	1.30	1.40
E	.049	.051	.054	1.25	1.30	1.375
E1	.008	.012	.016	0.20	0.30	0.40
e	.016 BSC		0.40 BSC			
L	.008	.010	.012	0.20	0.25	0.30
N	8		8			
aaa	.003		0.08			
bbb	.004		0.10			

**NOTES:**

1. CONTROLLING DIMENSIONS ARE IN MILLIMETERS (ANGLES IN DEGREES).
2. COPLANARITY APPLIES TO THE EXPOSED PAD AS WELL AS THE TERMINALS.

## Land Pattern - SLP1713P8

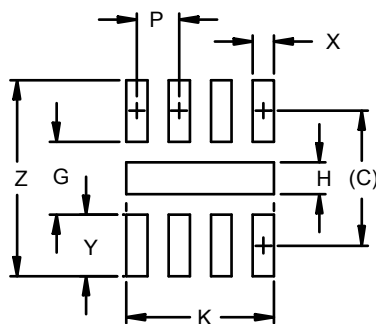

DIM	DIMENSIONS	
	INCHES	MILLIMETERS
C	(.050)	(1.27)
G	.027	0.69
H	.012	0.30
K	.055	1.40
P	.016	0.40
X	.008	0.20
Y	.023	0.58
Z	.073	1.85

**NOTES:**

1. CONTROLLING DIMENSIONS ARE IN MILLIMETERS (ANGLES IN DEGREES).
2. THIS LAND PATTERN IS FOR REFERENCE PURPOSES ONLY. CONSULT YOUR MANUFACTURING GROUP TO ENSURE YOUR COMPANY'S MANUFACTURING GUIDELINES ARE MET.

## Marking

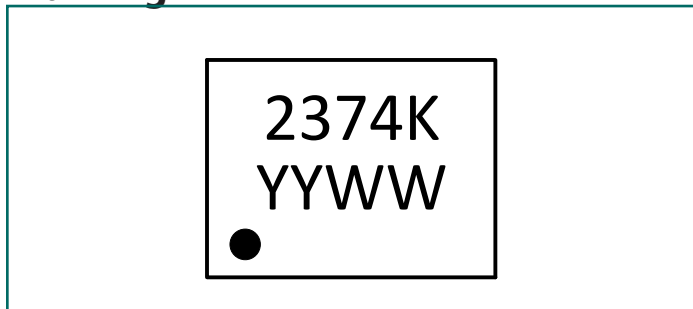

## Tape and Reel Specification

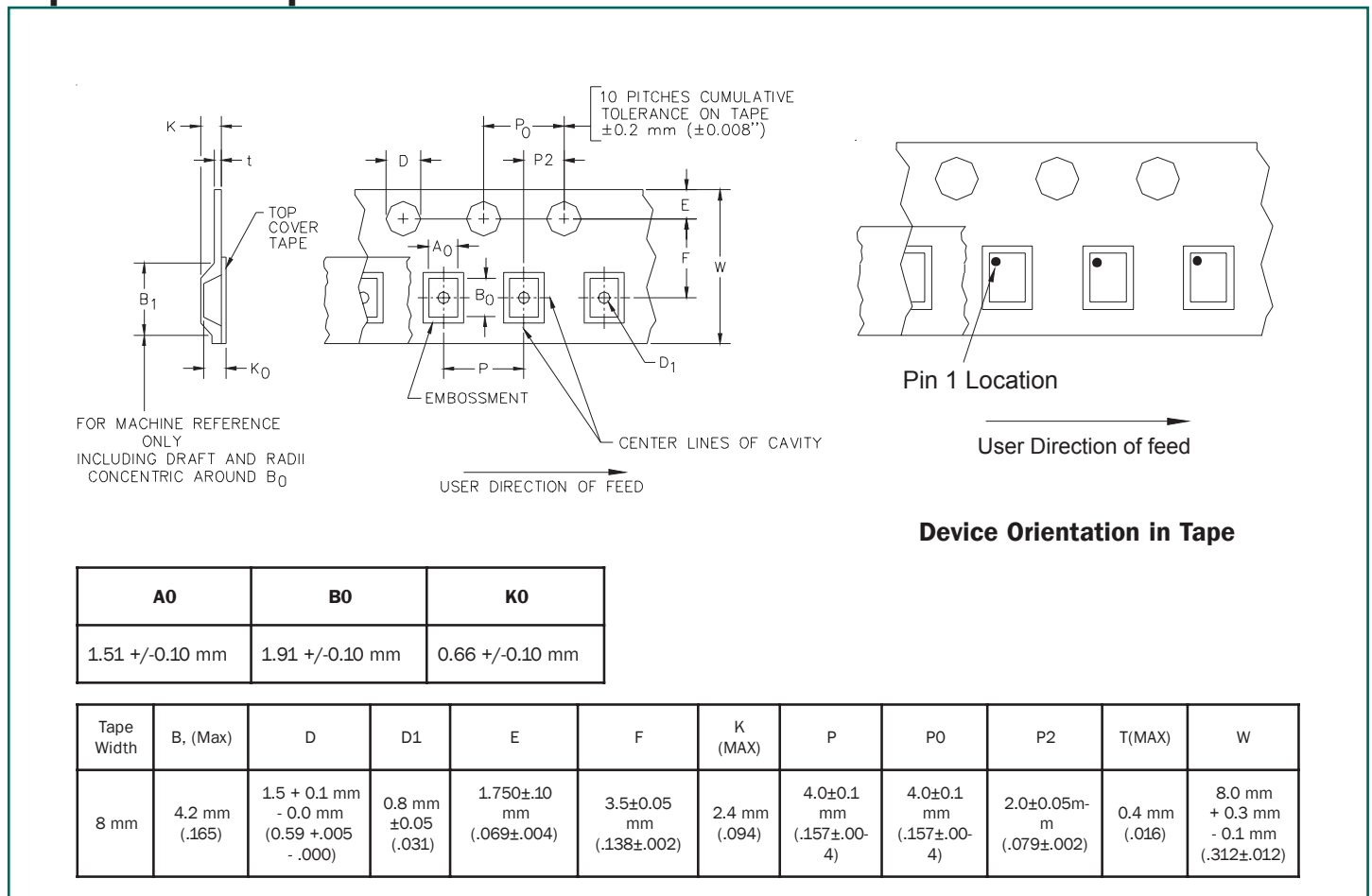

## Ordering Information

Part Number	Working Voltage	Qty per Reel	Reel Size
EClamp2374KQTCT	5V	3,000	7"

EClamp and EMIClamp are trademarks of Semtech Corporation





---

#### IMPORTANT NOTICE

Information relating to this product and the application or design described herein is believed to be reliable, however such information is provided as a guide only and Semtech assumes no liability for any errors in this document, or for the application or design described herein. Semtech reserves the right to make changes to the product or this document at any time without notice. Buyers should obtain the latest relevant information before placing orders and should verify that such information is current and complete. Semtech warrants performance of its products to the specifications applicable at the time of sale, and all sales are made in accordance with Semtech's standard terms and conditions of sale.

SEMTECH PRODUCTS ARE NOT DESIGNED, INTENDED, AUTHORIZED OR WARRANTED TO BE SUITABLE FOR USE IN LIFE-SUPPORT APPLICATIONS, DEVICES OR SYSTEMS, OR IN NUCLEAR APPLICATIONS IN WHICH THE FAILURE COULD BE REASONABLY EXPECTED TO RESULT IN PERSONAL INJURY, LOSS OF LIFE OR SEVERE PROPERTY OR ENVIRONMENTAL DAMAGE. INCLUSION OF SEMTECH PRODUCTS IN SUCH APPLICATIONS IS UNDERSTOOD TO BE UNDERTAKEN SOLELY AT THE CUSTOMER'S OWN RISK. Should a customer purchase or use Semtech products for any such unauthorized application, the customer shall indemnify and hold Semtech and its officers, employees, subsidiaries, affiliates, and distributors harmless against all claims, costs damages and attorney fees which could arise.

The Semtech name and logo are registered trademarks of the Semtech Corporation. All other trademarks and trade names mentioned may be marks and names of Semtech or their respective companies. Semtech reserves the right to make changes to, or discontinue any products described in this document without further notice. Semtech makes no warranty, representation or guarantee, express or implied, regarding the suitability of its products for any particular purpose. All rights reserved.

© Semtech 2015

---

#### Contact Information

Semtech Corporation  
200 Flynn Road, Camarillo, CA 93012  
Phone: (805) 498-2111, Fax: (805) 498-3804  
[www.semtech.com](http://www.semtech.com)

## X-ON Electronics

Largest Supplier of Electrical and Electronic Components

*Click to view similar products for [ESD Suppressors / TVS Diodes](#) category:*

*Click to view products by [Semtech](#) manufacturer:*

Other Similar products are found below :

[60KS200C](#) [D12V0H1U2WS-7](#) [D18V0L1B2LP-7B](#) [82356050220](#) [D5V0M5U6V-7](#) [NTE4902](#) [P4KE27CA](#) [P6KE11CA](#) [P6KE39CA-TP](#)  
[P6KE8.2A](#) [SA110CA](#) [SA60CA](#) [SA64CA](#) [SMBJ12CATR](#) [SMBJ8.0A](#) [SMLJ30CA-TP](#) [ESD101-B1-02ELS E6327](#) [ESD112-B1-02EL E6327](#)  
[ESD119B1W01005E6327XTSA1](#) [ESD5V0J4-TP](#) [ESD5V0L1B02VH6327XTSA1](#) [ESD7451N2T5G](#) [19180-510](#) [CPDT-5V0USP-HF](#)  
[3.0SMCJ33CA-F](#) [3.0SMCJ36A-F](#) [HSPC16701B02TP](#) [D3V3Q1B2DLP3-7](#) [D55V0M1B2WS-7](#) [DESD5V0U1BL-7B](#) [DRTR5V0U4SL-7](#)  
[SCM1293A-04SO](#) [ESD200-B1-CSP0201 E6327](#) [ESD203-B1-02EL E6327](#) [SM12-7](#) [SMF8.0A-TP](#) [SMLJ45CA-TP](#) [CEN955 W/DATA](#)  
[82350120560](#) [82356240030](#) [VESD12A1A-HD1-GS08](#) [CPDUR5V0R-HF](#) [CPDUR24V-HF](#) [CPDQC5V0U-HF](#) [CPDQC5V0USP-HF](#)  
[CPDQC5V0-HF](#) [D1213A-01LP4-7B](#) [D1213A-02WL-7](#) [ESDLIN1524BJ-HQ](#) [5KP100A](#)