

PROTECTION PRODUCTS - EMIClamp™

Description

The EClamp™2376P is a low pass filter array with integrated TVS diodes. It is designed to suppress unwanted EMI/RFI signals and provide electrostatic discharge (ESD) protection in portable electronic equipment. This state-of-the-art device utilizes solid-state silicon-avalanche technology for superior clamping performance and DC electrical characteristics. They have been optimized for **protection of color LCD panels** in cellular phones and other portable electronics.

The device consists of six identical circuits comprised of TVS diodes for ESD protection, and a resistor - capacitor network for EMI/RFI filtering. A series resistor value of 100Ω and a capacitance value of 10pF are used to achieve 30dB minimum attenuation from 1.8GHz to 2.5GHz. The TVS diodes provide effective suppression of ESD voltages in excess of ±15kV (air discharge) and ±8kV (contact discharge) per IEC 61000-4-2, level 4.

The EClamp2376P is in a 12-pin, RoHS compliant, SLP3016P12 package. It measures 3.0 x 1.6 x 0.58mm. The leads are spaced at a pitch of 0.5mm and are finished with lead-free NiPd. The small package makes it ideal for use in portable electronics such as cell phones, digital still cameras, and PDAs.

Circuit Diagram (Each Line)

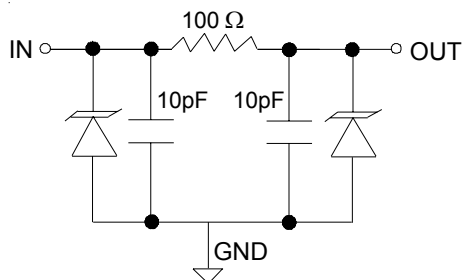

Device Schematic (6X)

Features

- ◆ Bidirectional EMI/RFI filter with integrated TVS for ESD protection
- ◆ ESD protection to **IEC 61000-4-2 (ESD) Level 4, ±15kV (air), ±8kV (contact)**
- ◆ Filter performance: 30dB minimum attenuation 1.8GHz to 2.5GHz
- ◆ TVS working voltage: 5V
- ◆ Resistor: 100Ω +/- 15%
- ◆ Typical Capacitance: 20pF (VR = 0V)
- ◆ Protection and filtering for six lines
- ◆ Solid-state technology

Mechanical Characteristics

- ◆ SLP3016P12 12-pin package
- ◆ RoHS/WEEE Compliant
- ◆ Nominal Dimensions: 3.0 x 1.6 x 0.58 mm
- ◆ Lead Pitch: 0.5mm
- ◆ Lead finish: NiPd
- ◆ Marking : Marking Code
- ◆ Packaging : Tape and Reel per EIA 481

Applications

- ◆ Color LCD Protection
- ◆ Cell Phone CCD Camera Lines
- ◆ Clamshell Cell Phones

Package Configuration

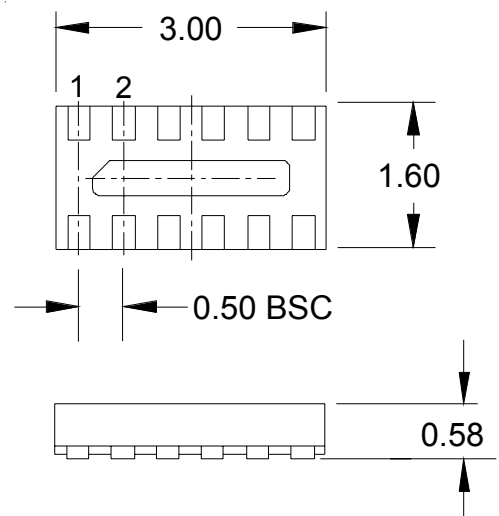

**12 Pin SLP package (Bottom Side View)
Nominal Dimensions in mm**

PROTECTION PRODUCTS

Maximum Ratings

| Rating | Symbol | Value | Units |
|--|-----------|------------------|-------|
| ESD per IEC 61000-4-2 (Air) ESD per IEC 61000-4-2 (Contact) | V_{ESD} | +/- 17 +/- 12 | kV |
| Junction Temperature | T_J | 125 | °C |
| Operating Temperature | T_{op} | -40 to +85 | °C |
| Storage Temperature | T_{STG} | -55 to +150 | °C |

Electrical Characteristics (T = 25°C)

| Parameter | Symbol | Conditions | Minimum | Typical | Maximum | Units |
|-------------------------------|-----------|--|---------|---------|---------|-------|
| TVS Reverse Stand-Off Voltage | V_{RWM} | | | | 5 | V |
| TVS Reverse Breakdown Voltage | V_{BR} | $I_t = 1mA$ | 6 | 8 | 10 | V |
| TVS Reverse Leakage Current | I_R | $V_{RWM} = 3.0V$ | | | 0.5 | μA |
| Total Series Resistance | R | Each Line | 85 | 100 | 115 | Ohms |
| Total Capacitance | C_{in} | Input to Gnd, Each Line $V_R = 0V, f = 1MHz$ | 16 | 20 | 24 | pF |
| Total Capacitance | C_{in} | Input to Gnd, Each Line $V_R = 2.5V, f = 1MHz$ | 9 | 11 | 13 | pF |

PROTECTION PRODUCTS

Typical Characteristics

Typical Insertion Loss S21 (Each Line)

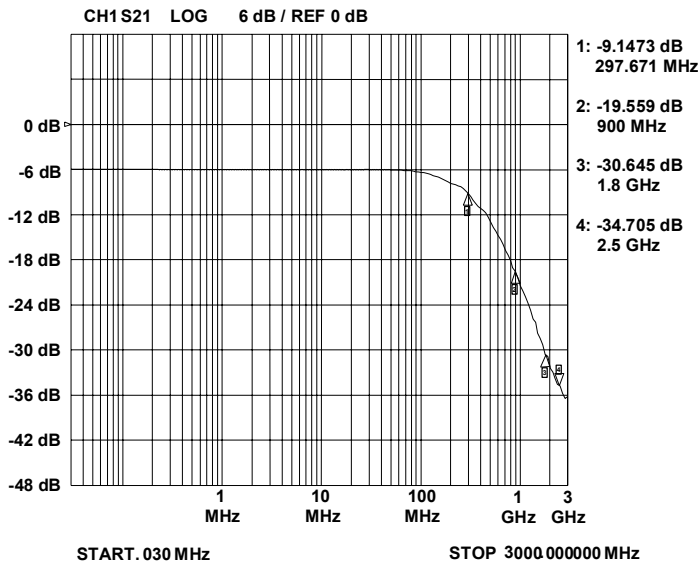

Analog Crosstalk (Each Line)

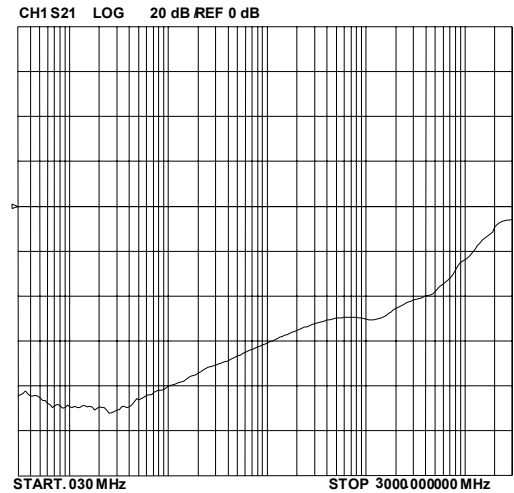

ESD Clamping (+8kV Contact)

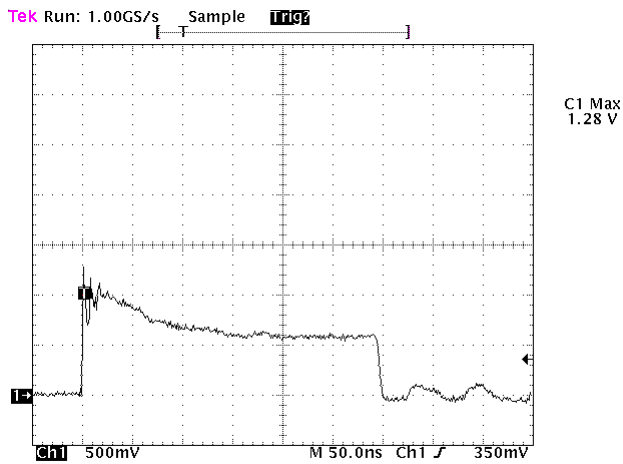

ESD Clamping (-8kV Contact)

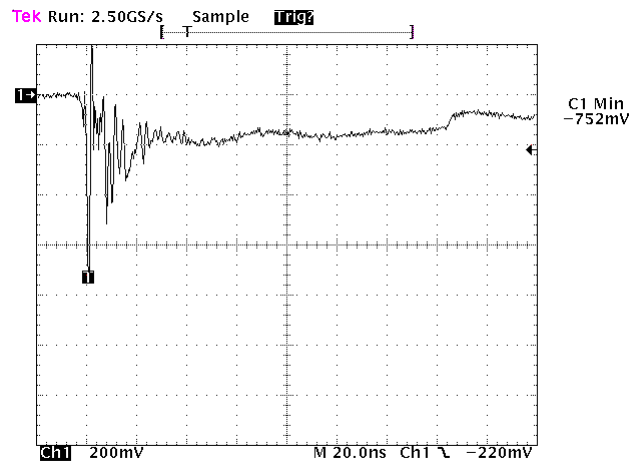

Capacitance vs. Reverse Voltage (Normalized to 0 volts)

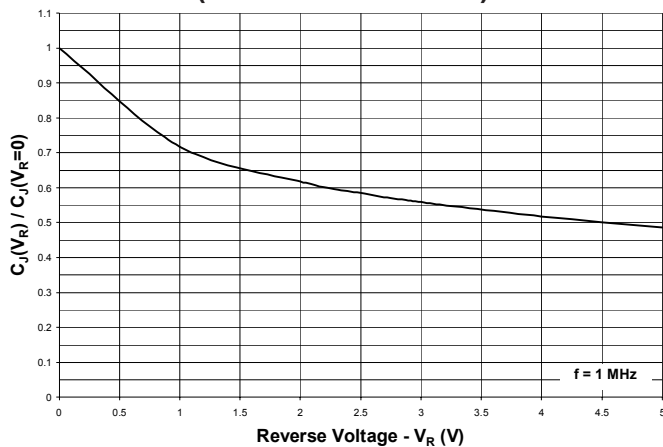

PROTECTION PRODUCTS

Device Connection

The EClamp2376P is comprised of six identical circuits each consisting of a low pass filter for EMI/RFI suppression and dual TVS diodes for ESD protection. The device is in a 12-pin SLP package. Electrical connection is made to the 12 pins located at the bottom of the device. A center tab serves as the ground connection. The device has a flow through design for easy layout. Pin connections are noted in Figure 1. All path lengths should be kept as short as possible to minimize the effects of parasitic inductance in the board traces. Recommendations for the ground connection are given below.

Figure 1 - Pin Identification and Configuration (Top Side View)

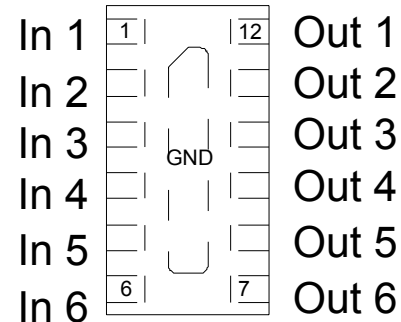

| Pin | Identification |
|------------|----------------|
| 1 - 6 | Input Lines |
| 7 - 12 | Output Lines |
| Center Tab | Ground |

Ground Connection Recommendation

Parasitic inductance present in the board layout will affect the filtering performance of the device. As frequency increases, the effect of the inductance becomes more dominant. This effect is given by Equation 1.

Equation 1: The Impedance of an Inductor at Frequency XLF

$$X_{LF}(L, f) = 2 * \pi * f * L$$

Where:

L = Inductance (H)

f = Frequency (Hz)

Via connections to the ground plane form rectangular wire loops or ground loop inductance as shown in Figure 2. Ground loop inductance can be reduced by using multiple vias to make the connection to the ground plane. Bringing the ground plane closer to the signal layer (preferably the next layer) also reduces ground loop inductance. Multiple vias in the device ground pad will result in a lower inductive ground loop over two exterior vias. Vias with a diameter d are separated by a distance y run between layers separated by a distance x . The inductance of the loop path is given by Equation 2. Thus, decreasing distance x and y will reduce the loop inductance and result in better high frequency filter characteristics.

Figure 2 - Inductance of Rectangular Wire Loops

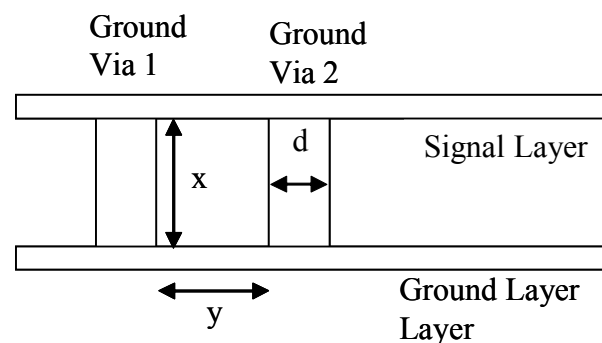

Equation 2: Inductance of Rectangular Wire Loop

$$L_{RECT}(d, x, y) = 10.16 * 10^{-9} * \left[x * \ln\left[\frac{2*y}{d}\right] + y * \ln\left[\frac{2*x}{d}\right] \right]$$

Where:

d = Diameter of the wire (in)

x = Length of wire loop (in)

y = Breadth of wire loop (in)

PROTECTION PRODUCTS

Applications Information

Figure 3 shows the recommended device layout. The ground pad vias have a diameter of 0.008 inches (0.20 mm) while the two external vias have a diameter of 0.010 inches (0.250mm). The internal vias are spaced approximately evenly from the center of the pad. The designer may choose to use more vias with a smaller diameter (such as 0.005 inches or 0.125mm) since changing the diameter of the via will result in little change in inductance (i.e. the log function in Equation 2 in highly insensitive to parameter d) . Figure 4 shows a typical insertion loss (S21) plot for the device using Semtech’s filter evaluation board with 50 Ohm traces and the recommended via configuration. Figure 5 shows a typical insertion loss (S21) plot using a similar board without the internal ground pad vias. The result is a more inductive ground loop. Note the “hump” at a frequency of 2.5GHz. This is the resonant frequency of the higher ground loop inductance.

Figure 3 - Recommended Layout Using Ground Vias

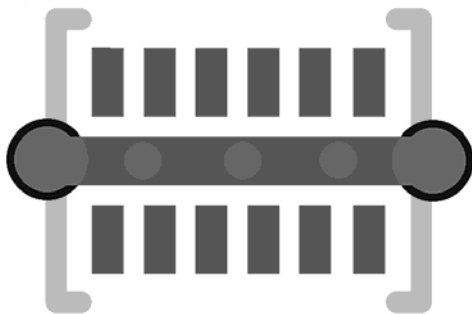

Figure 4 - Filter Characteristics Using Recommended Layout with Internal Vias

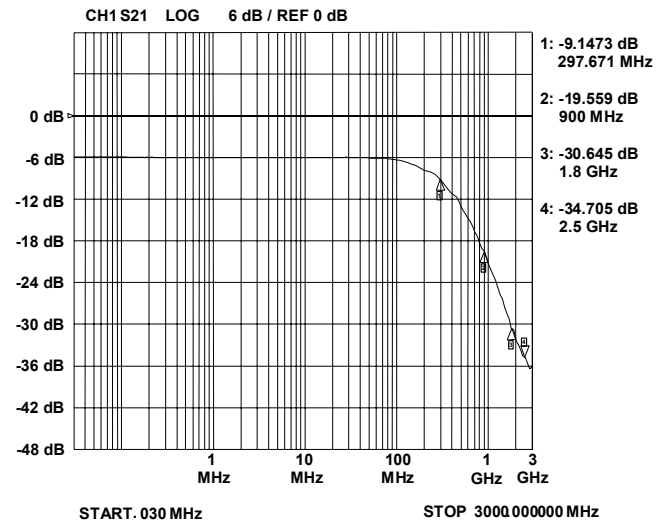
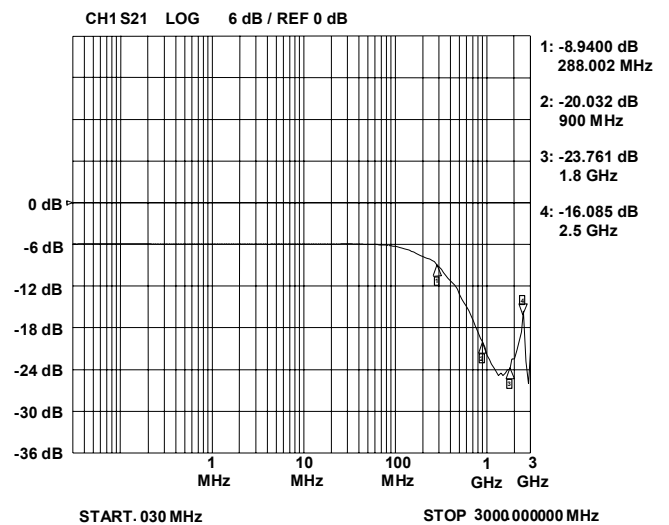

Figure 5 - Filter Characteristics Using Layout without Internal Ground Vias



PROTECTION PRODUCTS

Applications Information - Spice Model

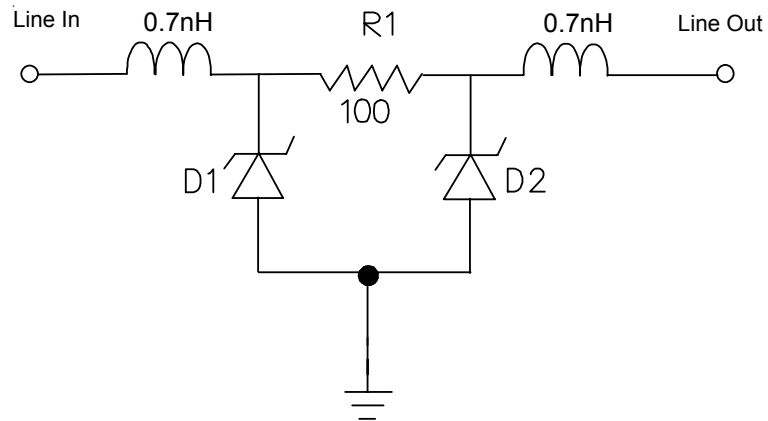
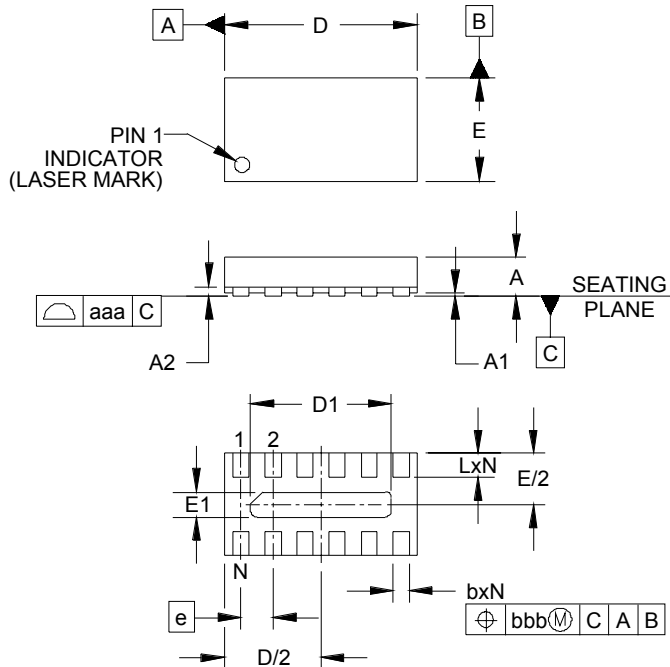

Figure 1 - EClamp2376P Spice Model

| Table 1 - EClamp2376P Spice Parameters | | | |
|---|-------------|-----------------|-----------------|
| Parameter | Unit | D1 (TVS) | D2 (TVS) |
| IS | Amp | 2E-15 | 2E-15 |
| BV | Volt | 7.42 | 7.42 |
| VJ | Volt | 0.775 | 0.775 |
| RS | Ohm | 1.00 | 1.00 |
| IBV | Amp | 1E-3 | 1E-3 |
| CJO | Farad | 9.8E-12 | 9.8E-12 |
| TT | sec | 2.541E-9 | 2.541E-9 |
| M | -- | 0.246 | 0.246 |
| N | -- | 1.1 | 1.1 |
| EG | eV | 1.11 | 1.11 |

PROTECTION PRODUCTS

Outline Drawing - SLP3016P12



| DIM | INCHES | | | MILLIMETERS | | |
|-----|----------|------|------|-------------|------|------|
| | MIN | NOM | MAX | MIN | NOM | MAX |
| A | .020 | .023 | .026 | 0.50 | 0.58 | 0.65 |
| A1 | .000 | .001 | .002 | 0.00 | .003 | 0.05 |
| A2 | (.006) | | | (0.15) | | |
| b | .007 | .010 | .012 | 0.20 | 0.25 | 0.30 |
| D | .114 | .118 | .122 | 2.90 | 3.00 | 3.10 |
| D1 | .083 | .087 | .091 | 2.10 | 2.20 | 2.30 |
| E | .059 | .063 | .067 | 1.50 | 1.60 | 1.70 |
| E1 | .010 | .016 | .020 | 0.25 | 0.40 | 0.50 |
| e | .020 BSC | | | 0.50 BSC | | |
| L | .011 | .013 | .015 | 0.28 | 0.33 | 0.38 |
| N | 12 | | | 12 | | |
| aaa | .003 | | | 0.08 | | |
| bbb | .004 | | | 0.10 | | |

NOTES:

1. CONTROLLING DIMENSIONS ARE IN MILLIMETERS (ANGLES IN DEGREES).
2. COPLANARITY APPLIES TO THE EXPOSED PAD AS WELL AS THE TERMINALS.

Land Pattern - SLP3016P12

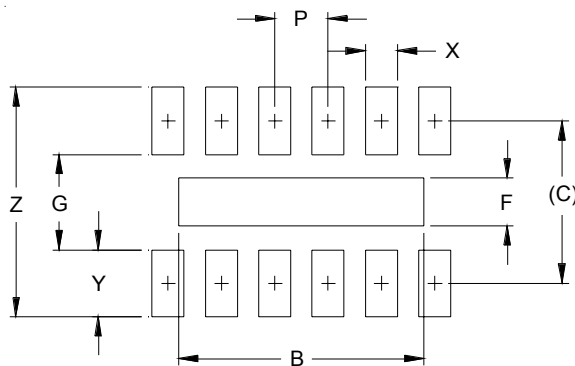

| DIM | DIMENSIONS | |
|-----|------------|-------------|
| | INCHES | MILLIMETERS |
| B | .091 | 2.30 |
| C | .060 | 1.52 |
| F | .018 | 0.45 |
| G | .035 | 0.89 |
| P | .020 | 0.50 |
| X | .012 | 0.30 |
| Y | .025 | 0.63 |
| Z | .085 | 2.15 |

NOTES:

1. THIS LAND PATTERN IS FOR REFERENCE PURPOSES ONLY. CONSULT YOUR MANUFACTURING GROUP TO ENSURE YOUR COMPANY'S MANUFACTURING GUIDELINES ARE MET

PROTECTION PRODUCTS

Marking

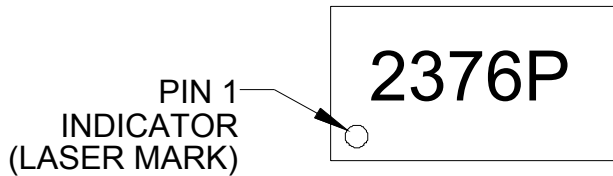

Ordering Information

| Part Number | Qty per Reel | Reel Size |
|-----------------|--------------|-----------|
| EClamp2376P.TCT | 3000 | 7 Inch |

EMIClamp and EClamp are marks of Semtech Corporation

Tape and Reel Specification

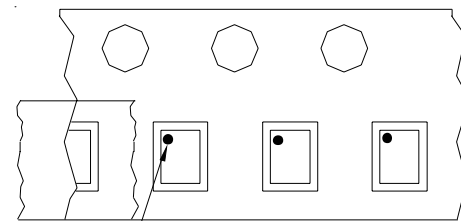
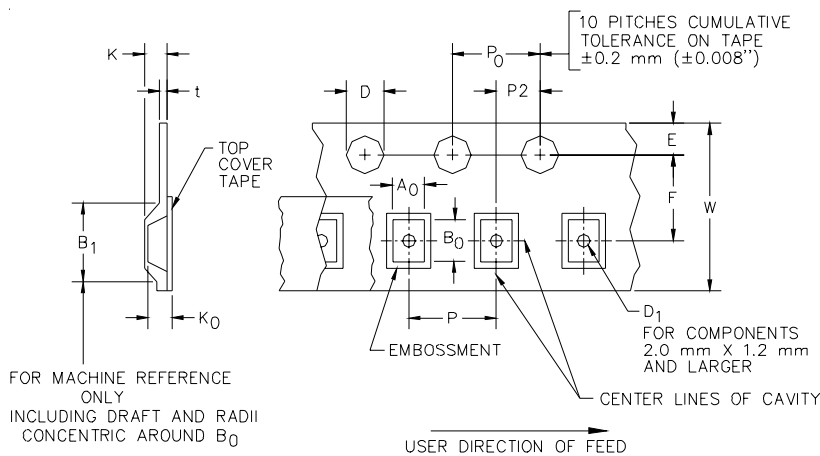

Pin 1 Location

→ User Direction of feed

Device Orientation in Tape

| A0 | B0 | K0 |
|-----------------|-----------------|-----------------|
| 1.78 +/-0.05 mm | 3.18 +/-0.05 mm | 0.76 +/-0.05 mm |

| Tape Width | B, (Max) | D | D1 | E | F | K (MAX) | P | P0 | P2 | T(MAX) | W |
|------------|---------------|---|---------------------|--------------------------|-------------------------|---------------|-------------------------|-------------------------|------------------------|---------------|--------------------------------------|
| 8 mm | 4.2 mm (.165) | 1.5 + 0.1 mm - 0.0 mm (0.59 +.005 - .000) | 0.8 mm ±0.05 (.031) | 1.750±.10 mm (.069±.004) | 3.5±0.05 mm (.138±.002) | 2.4 mm (.094) | 4.0±0.1 mm (.157±.00-4) | 4.0±0.1 mm (.157±.00-4) | 2.0±0.05mm (.079±.002) | 0.4 mm (.016) | 8.0 mm + 0.3 mm - 0.1 mm (.312±.012) |

Contact Information for Semtech International AG

Taiwan Branch Tel: 886-2-2748-3380
Fax: 886-2-2748-3390

Korea Branch Tel: 82-2-527-4377
Fax: 82-2-527-4376

Shanghai Office Tel: 86-21-6391-0830
Fax: 86-21-6391-0831

Semtech International AG is a wholly-owned subsidiary of Semtech Corporation, which has its headquarters in the U.S.A.

Semtech Switzerland GmbH Tel: 81-3-6408-0950
Japan Branch Fax: 81-3-6408-0951

Semtech Limited (U.K.) Tel: 44-1794-527-600
Fax: 44-1794-527-601

Semtech France SARL Tel: 33-(0)169-28-22-00
Fax: 33-(0)169-28-12-98

Semtech Germany GmbH Tel: 49-(0)8161-140-123
Fax: 49-(0)8161-140-124

X-ON Electronics

Largest Supplier of Electrical and Electronic Components

Click to view similar products for [ESD Suppressors / TVS Diodes](#) category:

Click to view products by [Semtech](#) manufacturer:

Other Similar products are found below :

[60KS200C](#) [D12V0H1U2WS-7](#) [D18V0L1B2LP-7B](#) [82356050220](#) [D5V0M5U6V-7](#) [NTE4902](#) [P4KE27CA](#) [P6KE11CA](#) [P6KE39CA-TP](#)
[P6KE8.2A](#) [SA110CA](#) [SA60CA](#) [SA64CA](#) [SMBJ12CATR](#) [SMBJ8.0A](#) [SMLJ30CA-TP](#) [ESD101-B1-02ELS E6327](#) [ESD112-B1-02EL E6327](#)
[ESD119B1W01005E6327XTSA1](#) [ESD5V0L1B02VH6327XTSA1](#) [ESD7451N2T5G](#) [19180-510](#) [CPDT-5V0USP-HF](#) [3.0SMCJ33CA-F](#)
[3.0SMCJ36A-F](#) [HSPC16701B02TP](#) [D3V3Q1B2DLP3-7](#) [D55V0M1B2WS-7](#) [DESD5V0U1BL-7B](#) [DRTR5V0U4SL-7](#) [SCM1293A-04SO](#)
[ESD200-B1-CSP0201 E6327](#) [ESD203-B1-02EL E6327](#) [SM12-7](#) [SMF8.0A-TP](#) [SMLJ45CA-TP](#) [CEN955 W/DATA](#) [82350120560](#)
[82356240030](#) [VESD12A1A-HD1-GS08](#) [CPDUR5V0R-HF](#) [CPDUR24V-HF](#) [CPDQC5V0U-HF](#) [CPDQC5V0USP-HF](#) [CPDQC5V0-HF](#)
[D1213A-01LP4-7B](#) [D1213A-02WL-7](#) [ESDLIN1524BJ-HQ](#) [5KP100A](#) [5KP15A](#)