



GS1881, GS4881, GS4981 Monolithic Video Sync Separators

Features

- noise tolerant odd/even flag, back porch and horizontal sync pulse
- fast recovery from impulse noise
- excellent temperature stability
- 0.5V to 4Vpp input signal amplitude with 5V supply
- well-controlled clamp discharge current and slicing level
- programmable horizontal scan rate (up to 130kHz)
- composite, vertical, back porch, odd/even (GS1881, GS4881), horizontal (GS4981) outputs
- predictable vertical output pulse width with default trigger for non-standard video signals
- Pb-free and Green
- 5V to 12V supply voltage range
- pin compatible with LM1881 sync separator

Application Selection Chart

Application	Choose Device:
Direct LM1881 Replacement with Improved Performance	GS1881
New Applications Substitution for LM1881	GS4881
New Applications Requiring Horizontal Sync Output	GS4981

Description

The GS1881, GS4881 and GS4981 are general purpose sync separators for use in a wide variety of video applications. The devices extract the timing information from composite video signals with scan rates from 15 to 130kHz.

The GS1881 is a drop-in replacement for the industry standard LM1881 with much improved performance. The device generates composite sync, vertical sync, back porch and odd/even field signals. The GS4881 is identical to the GS1881 but features a noise immune back porch pulse which maintains a constant H rate during the vertical interval. The GS4981 is identical to the GS4881, except that it provides horizontal sync in place of the odd/even output.

All three devices feature a self-adjusting windowing circuit for noise immunity, which synchronizes to H rate. This windowing circuit determines the odd or even field in the GS1881 and GS4881, gates the back porch pulse in the GS4881 and GS4981, and generates the horizontal sync output in the GS4981.

The devices feature an improved input stage which ensures that the input signal is sliced at a predictable point due to well-controlled input clamp discharge current and sync slicing level. A missing pulse detector enables the devices to recover quickly from impulse noise disturbances by temporarily increasing the clamp discharge current by roughly ten times. The input stage will operate with signals from 0.5 to 4Vp-p with a 5V supply.

The GS1881, GS4881 and GS4981 also feature a predictable vertical output pulse width with a default trigger for non-standard video signals. All three are available in commercial and industrial temperature ranges and are packaged in both DIP and SOIC.

Revision History

Version	Date	Changes and/or Modifications
5	November 2009	Updated to latest Gennum template and changed from document number 52023 to 6926.
4	July 2004	Added lead-free and green information.
3	–	Revisions made.
2	–	Revisions made.
1	March 1991	New document.

Contents

Features.....	1
Application Selection Chart	1
Description.....	1
Revision History	2
1. Pin Connections	3
1.1 Pin Connections	3
2. Electrical Characteristics	4
2.1 GS1881 Electrical Characteristics	4
2.2 GS4881 Electrical Characteristics	5
2.3 GS4981 Electrical Characteristics	6
2.4 Typical Performance Characteristics	8
3. Temperature Characteristics	11
4. Circuit Description.....	14
4.1 Composite Video Input (Pin 2) and Composite Sync Output (Pin 1)	14
4.2 Back Porch Output (Pin 5)	15
4.3 Vertical Sync Output (Pin 3)	16
4.4 Odd/Even Field Output (Pin 7 GS1881, GS4881)	16
4.5 Horizontal Output (Pin 7 GS4981)	17
4.6 Block Diagrams	17
5. Application Notes.....	20
5.1 Choosing the Appropriate Input Capacitor to Optimize Slicing Level and Hum Rejection	20
5.2 Filtering	22
5.3 Deriving Odd/Even Using the GS4981	25
6. Ordering Information.....	27
6.1 GS1881 Ordering Information	27
6.2 GS4881 Ordering Information	27
6.3 GS4981 Ordering Information	28

1. Pin Connections

1.1 Pin Connections

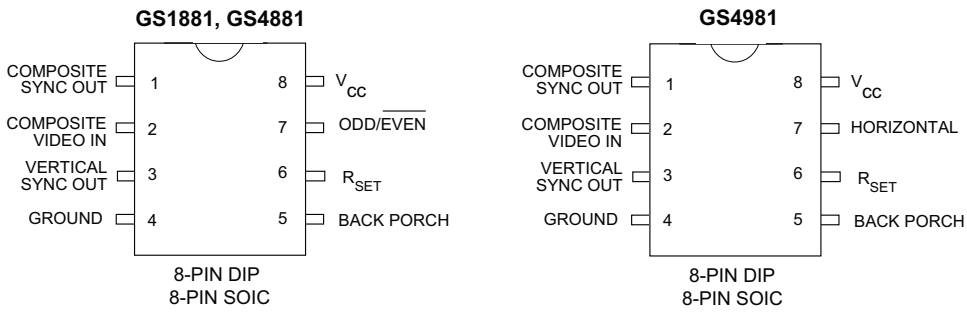

Figure 1-1: 8-Pin DIP, 8-Pin SOIC

2. Electrical Characteristics

2.1 GS1881 Electrical Characteristics

Table 2-1 shows the electrical characteristics of the GS1881 where conditions are $V_{CC} = 5V$, $R_{SET} = 680k\Omega$, $T_A = 25^\circ C$, unless otherwise shown.

Table 2-1: GS1881 Electrical Characteristics

Parameter	Conditions	Min	Typ	Max	Units	
Supply Voltage	–	4.5	5	13.2	V	
Supply Current	Outputs at Logic 1	$V_{CC} = 5V$	–	4.6	30	mA
		$V_{CC} = 12V$	–	5.0	6.5	mA
Video Input (Pin 2)						
(a) Signal Level	$V_{CC} = 5V$	0.5	–	4	Vp-p	
(b) Clamp Current	Charge	500	650	850	μA	
	Discharge - normal	9	11	13	μA	
	Discharge - Nosync flag raised	65	95	115	μA	
(c) Delay to raising of Nosync flag	Video input held high	64	95	130	μs	
(d) Sync Tip Clamp Voltage	–	–	1.55	–	V	
Sync Slice Level	Relative to sync tip clamp voltage	70	77	84	mV	
RSET Pin Reference Voltage (Pin 6)	See Note 1.	1.14	1.24	1.34	V	
Composite Sync Out (Pin 1)	See Note 2.	40	60	80	ns	
Delay from Video	$C_L = 15p$					
Back Porch Pulse Out (Pin 5)						
(a) Delay from Rising Edge of Sync	$C_L = 15p$	400	500	650	ns	
(b) Pulse Width		2.0	2.5	3.2	μs	
Vertical Sync Out (Pin 3)						
(a) Pulse Width	Serrations during vertical interval	197.7	197.7	197.7	μs	
(b) Default Starting Time	No serrations during vertical interval	48	65	82	μs	
Horizontal Scan Rate	Modified R_{SET}	15	–	130	kHz	
Logic Outputs						
(a) V_{OH}	$I_{OH} = 40\mu A$	$V_{CC} = 5V$	4.2	4.6	–	V
		$V_{CC} = 12V$	11.2	11.6	–	V
	$I_{OH} = 1.6mA$	$V_{CC} = 5V$	2.4	3.4	–	V
		$V_{CC} = 12V$	9.4	10.4	–	V

Table 2-1: GS1881 Electrical Characteristics (Continued)

Parameter	Conditions	Min	Typ	Max	Units
(b) V_{OL}	$I_{OL} = 1.6\text{mA}$	–	0.3	0.6	V

NOTES:

1. When placing the R_{SET} resistor and the 0.1 μF decoupling capacitor, careful attention should be made to ensure that they are as close as possible to Pin 6. Care should also be taken to avoid parasitic capacitive coupling from any output pin (Pins 1, 3, 5 and 7) to Pin 6.
2. Measured from slicing point of input falling edge to 50% point of composite sync falling edge.

2.2 GS4881 Electrical Characteristics

Table 2-2 shows the electrical characteristics of the GS4881 where conditions are $V_{CC} = 5\text{V}$, $R_{SET} = 680\text{k}\Omega$, $T_A = 25^\circ\text{C}$, unless otherwise shown.

Table 2-2: GS4881 Electrical Characteristics

Parameter	Conditions	Min	Typ	Max	Units	
Supply Voltage	–	4.5	5	13.2	V	
Supply Current	Outputs at Logic 1	$V_{CC} = 5\text{V}$	–	4.6	30	mA
		$V_{CC} = 12\text{V}$	–	5.0	6.5	mA
Video Input (Pin 2)						
(a) Signal Level	$V_{CC} = 5\text{V}$	0.5	–	4	Vp-p	
(b) Clamp Current	Charge	500	650	850	μA	
	Discharge - normal	9	11	13	μA	
	Discharge - Nosync flag raised	65	95	115	μA	
(c) Delay to raising of Nosync flag	Video input held high	64	95	130	μs	
(d) Sync Tip Clamp Voltage	–	–	1.55	–	V	
Sync Slice Level	Relative to sync tip clamp voltage	70	77	84	mV	
RSET Pin Reference Voltage (Pin 6)	See Note 1.	1.14	1.24	1.34	V	
Composite Sync Out (Pin 1)	See Note 2.	40	60	80	ns	
Delay from Video	$C_L = 15\text{p}$					
Back Porch Pulse Out (Pin 5)						
(a) Delay from Rising Edge of Sync	$C_L = 15\text{p}$	400	500	650	ns	
(b) Pulse Width		2.0	2.5	3.2	μs	
(c) Occurrence Rate		H	H	H	–	
Vertical Sync Out (Pin 3)						
(a) Pulse Width	Serrations during vertical interval	197.7	197.7	197.7	μs	
(b) Default Starting Time	No serrations during vertical interval	48	65	82	μs	

Table 2-2: GS4881 Electrical Characteristics (Continued)

Parameter	Conditions	Min	Typ	Max	Units	
Horizontal Scan Rate	Modified R _{SET}	15	–	130	kHz	
Logic Outputs						
(a) V _{OH}	I _{OH} = 40μA	V _{CC} = 5V	4.2	4.6	–	V
		V _{CC} = 12V	11.2	11.6	–	V
	I _{OH} = 1.6mA	V _{CC} = 5V	2.4	3.4	–	V
		V _{CC} = 12V	9.4	10.4	–	V
(b) V _{OL}	I _{OL} = 1.6mA	–	0.3	0.6	V	

NOTES:

1. When placing the R_{SET} resistor and the 0.1μF decoupling capacitor, careful attention should be made to ensure that they are as close as possible to Pin 6. Care should also be taken to avoid parasitic capacitive coupling from any output pin (Pins 1, 3, 5 and 7) to Pin 6.
2. Measured from slicing point of input falling edge to 50% point of composite sync falling edge.

2.3 GS4981 Electrical Characteristics

Table 2-2 shows the electrical characteristics of the GS4981 where conditions are V_{CC} = 5V, R_{SET} = 680kΩ, T_A = 25°C, unless otherwise shown.

Table 2-3: GS4981 Electrical Characteristics

Parameter	Conditions	Min	Typ	Max	Units	
Supply Voltage	–	4.5	5	13.2	V	
Supply Current	Outputs at Logic 1	V _{CC} = 5V	–	4.6	30	mA
		V _{CC} = 12V	–	5.0	6.5	mA
Video Input (Pin 2)						
(a) Signal Level	V _{CC} = 5V	0.5	–	4	Vp-p	
(b) Clamp Current	Charge	500	650	850	μA	
	Discharge - normal	9	11	13	μA	
	Discharge - Nosync flag raised	65	95	115	μA	
(c) Delay to raising of Nosync flag	Video input held high	64	95	130	μs	
(d) Sync Tip Clamp Voltage	–	–	1.55	–	V	
Sync Slice Level	Relative to sync tip clamp voltage	70	77	84	mV	
RSET Pin Reference Voltage (Pin 6)	See Note 1.	1.14	1.24	1.34	V	
Composite Sync Out (Pin 1)	See Note 2.	40	60	80	ns	
Delay from Video	C _L = 15p					
Back Porch Pulse Out (Pin 5)						

Table 2-3: GS4981 Electrical Characteristics (Continued)

Parameter	Conditions	Min	Typ	Max	Units	
(a) Delay from Rising Edge of Sync	$C_L = 15p$	400	500	650	ns	
(b) Pulse Width		2.0	2.5	3.2	μs	
(c) Occurrence Rate		H	H	H	–	
Vertical Sync Out (Pin 3)						
(a) Pulse Width	Serrations during vertical interval	197.7	197.7	197.7	μs	
(b) Default Starting Time	No serrations during vertical interval	48	65	82	μs	
Horizontal Sync Out (Pin 7)						
(a) Delay From Video	$C_L = 15p$	90	190	290	ns	
(b) Pulse Width		5.0	7.0	9.0	μs	
Horizontal Scan Rate	Modified R_{SET}	15	–	130	kHz	
Logic Outputs						
(a) V_{OH}	$I_{OH} = 40\mu A$	$V_{CC} = 5V$	4.2	4.6	–	V
		$V_{CC} = 12V$	11.2	11.6	–	V
	$I_{OH} = 1.6mA$	$V_{CC} = 5V$	2.4	3.4	–	V
		See Note 3.	$V_{CC} = 12V$	9.4	10.4	–
(b) V_{OL}	$I_{OL} = 1.6mA$	–	0.3	0.6	V	

NOTES:

1. When placing the R_{SET} resistor and the 0.1 μF decoupling capacitor, careful attention should be made to ensure that they are as close as possible to Pin 6. Care should also be taken to avoid parasitic capacitive coupling from any output pin (Pins 1, 3, 5 and 7) to Pin 6.
2. Measured from slicing point of input falling edge to 50% point of composite sync falling edge.
3. Applies only to composite sync, vertical sync, and back porch outputs. Horizontal sync has a passive 10k Ω pull-up to V_{CC} .

2.4 Typical Performance Characteristics

Figure 2-1 through Figure 2-6 show the typical performance characteristics for the GS1881, GS4881, and GS4981, where $V_S = 5V$, $T_A = 25^\circ C$, unless otherwise specified.

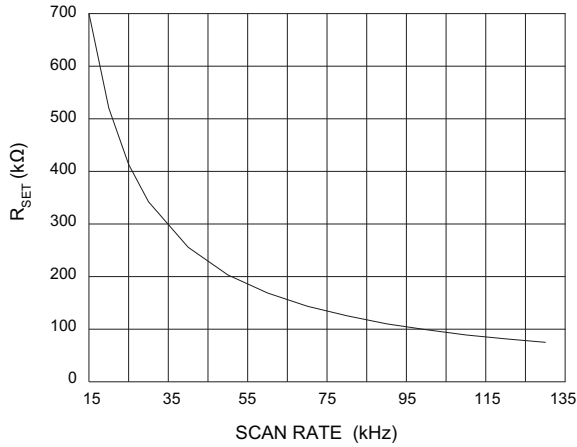

Figure 2-1: R_{SET} vs Scan Rate

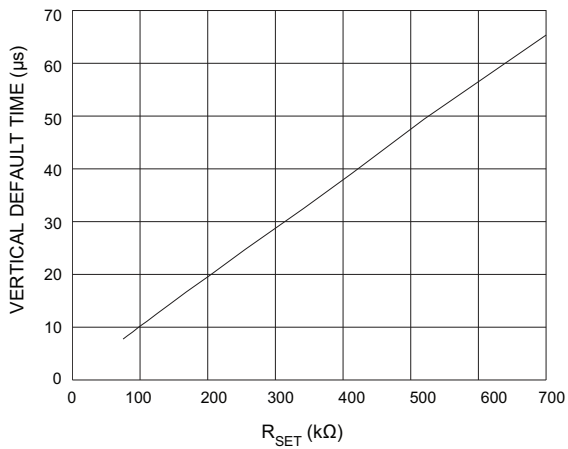

Figure 2-2: Vertical Sync Default Starting Time vs R_{SET}

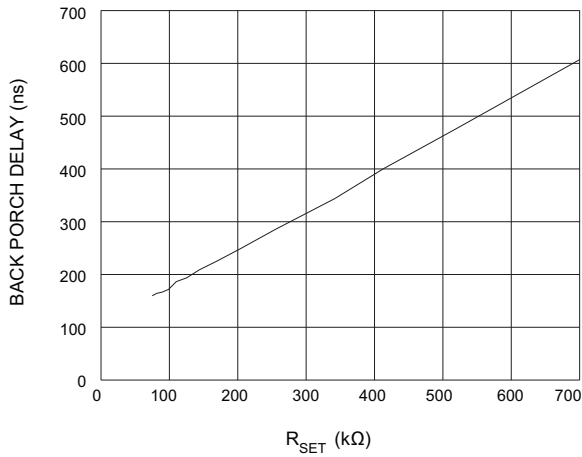

Figure 2-3: Back Porch Delay vs R_{SET}

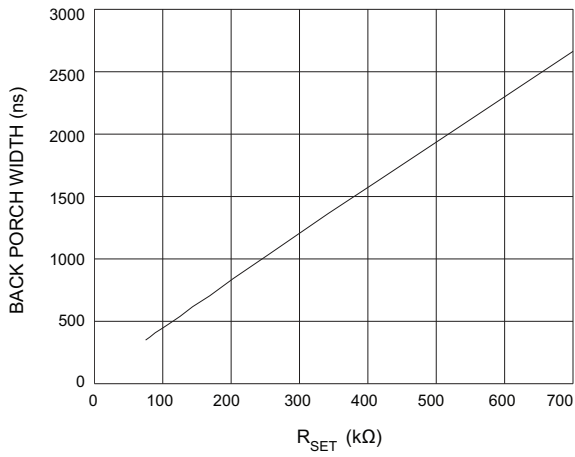

Figure 2-4: Back Porch Width vs R_{SET}

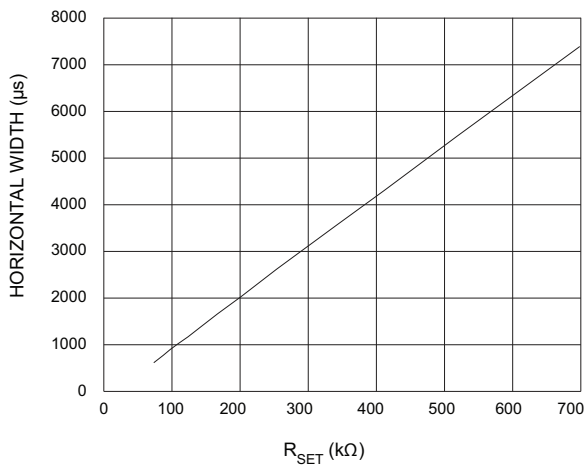

Figure 2-5: Horizontal Width vs R_{SET}

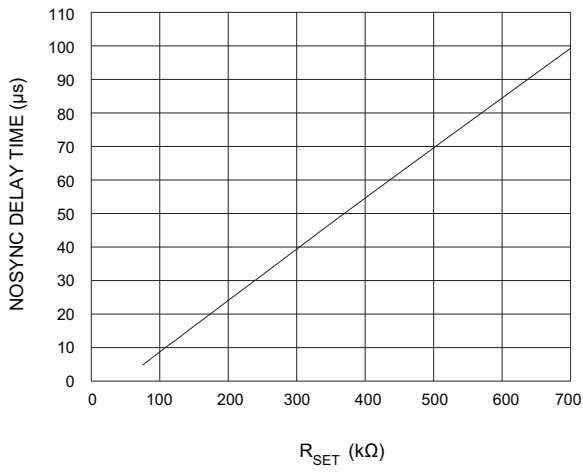

Figure 2-6: Nosync Delay Time vs R_{SET}

3. Temperature Characteristics

Figure 3-1 through Figure 3-6 show the typical temperature characteristics for the GS1881, GS4881, and GS4981, where $V_S = 5V$, $R_{SET} = 680k\Omega$, unless otherwise specified.

NOTE: Grey shading on Figure 3-1 through Figure 3-6 indicates commercial temperature range (0 to 70°C).

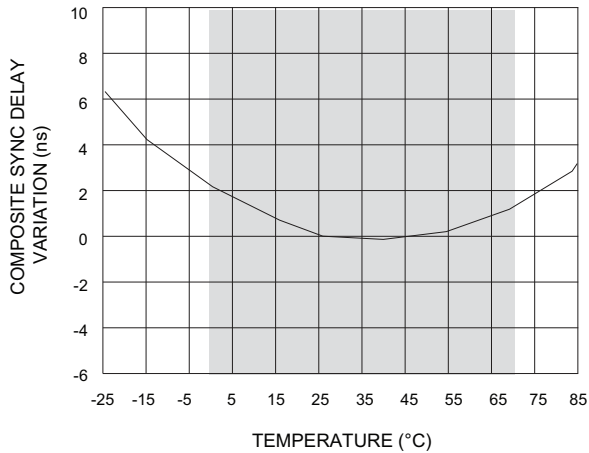

Figure 3-1: Composite Sync Delay Variation vs Temperature

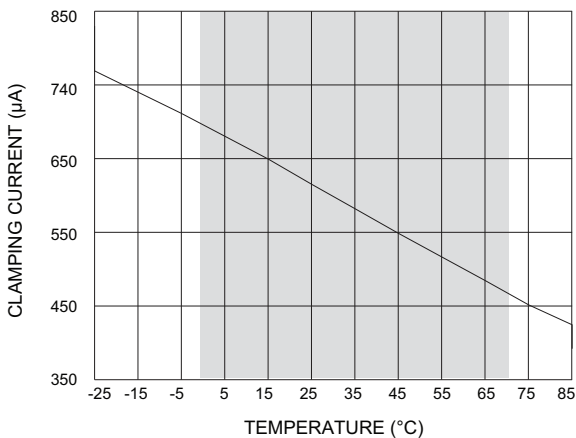

Figure 3-2: Clamping Current vs Temperature

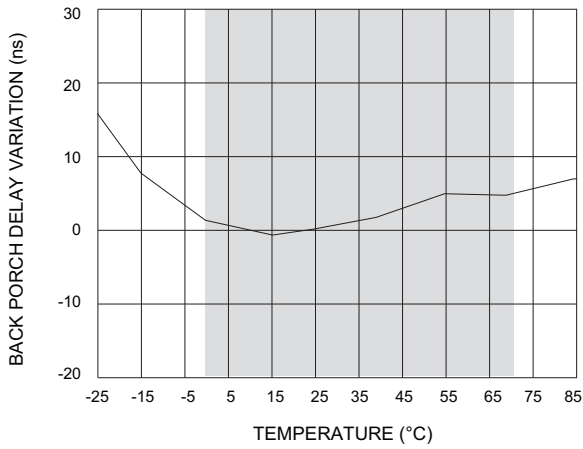

Figure 3-3: Back Porch Delay Variation vs Temperature

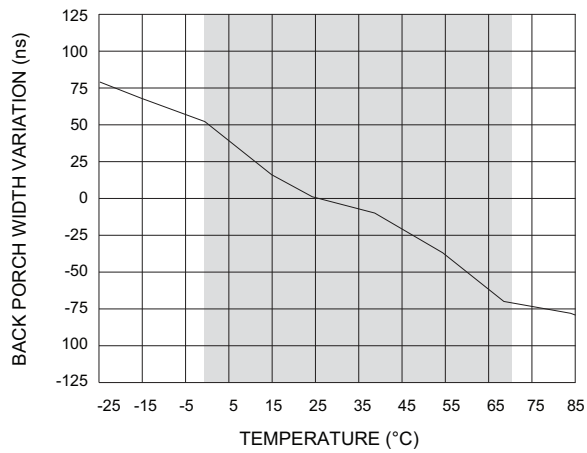

Figure 3-4: Back Porch Width Variation vs Temperature

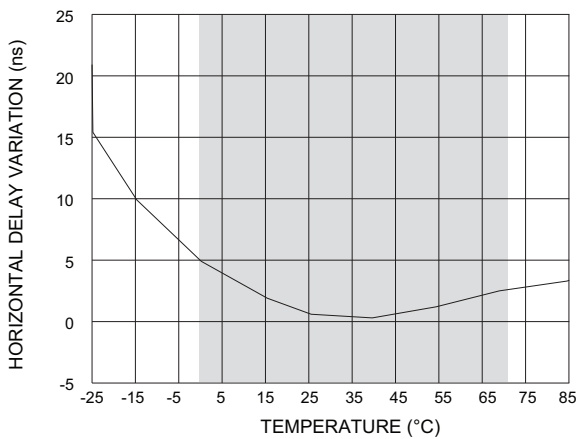

Figure 3-5: Horizontal Delay Variation vs Temperature

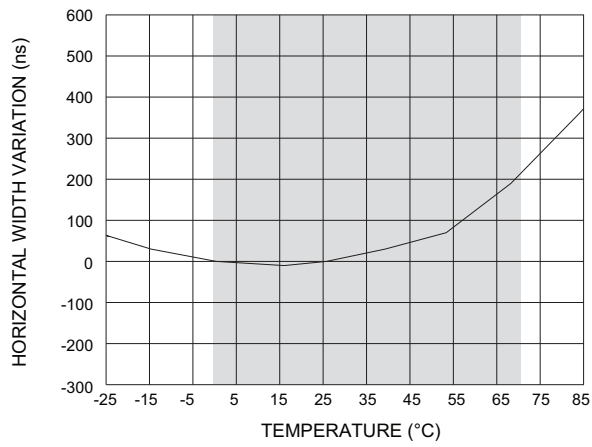

Figure 3-6: Horizontal Width Variation vs Temperature

4. Circuit Description

The block diagrams for the GS1881, GS4881 and GS4981, are shown in [Figure 4-5](#) through [Figure 4-7](#), with timing diagrams for the devices shown in [Figure 4-8](#).

When stimulated by a composite input signal, the GS1881 and GS4881 sync separators output composite sync, vertical sync, back porch, and odd/even field information. The GS4981 substitutes the odd/even output of the GS4881 with a horizontal output. An external resistor on Pin 6 is used to define internal currents allowing the devices to accommodate horizontal scan rates from 15kHz to 130kHz.

4.1 Composite Video Input (Pin 2) and Composite Sync Output (Pin 1)

Composite video is AC coupled via an external coupling capacitor to Pin 2. The device clamps the sync tip of the input video to 1.5V (V_{clamp}) and then slices at 77mV above the clamp voltage (V_{slice}). The resultant signal, provided at Pin 1, is a reproduction of the input signal with the active video portion removed. As V_{clamp} and V_{slice} are supply and input signal independent, for 0.5Vp-p signals (sync height of 143mV) slicing will occur at just above the 50% point and for 2Vp-p signals (sync height of 572mV) slicing will occur at approximately 13% of sync height.

The video signal path and composite sync slicing circuitry have been optimized and compensated to achieve a low propagation delay that is stable over temperature. The typical delay is 60ns with less than 3ns drift over the commercial temperature range.

The typical input clamp discharge current is 11 μ A. This current is optimal under normal operating circumstances but needs to be increased when the clamp is trying to recover from negative going impulse noise. The device improves the recovery time by raising a NOSYNC flag when there has not been a sync pulse for approximately 1 1/2 horizontal lines.

When this flag is raised the discharge current is increased by 85 μ A so that the recovery time is sped up by nearly 10 times. [Figure 4-1](#) shows a comparison between the recovery times with and without the increased discharge current.

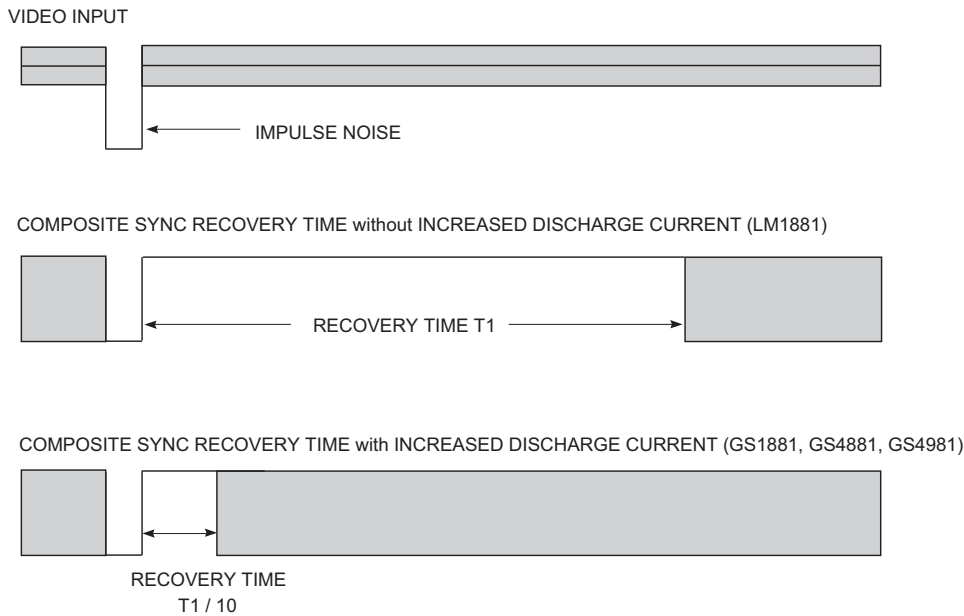

Figure 4-1: Impulse Noise: Recovery Time Comparison

4.2 Back Porch Output (Pin 5)

In an NTSC composite video signal, horizontal sync pulses are followed by the back porch interval. The device generates a negative going pulse on Pin 5 during this time. It is delayed typically 500ns from the rising edge of sync and has a typical width of 2.5 μ s. Both of these times are set by the external R_{SET} resistor.

During the pre-equalizing, vertical sync, and post-equalizing periods, composite sync doubles in frequency. The GS4881 and GS4981 maintain the back porch output at the horizontal rate due to Back Porch Enable (BPEN), generated by the internal windowing circuit, which forces back porch to be asserted at the horizontal rate. This gating circuit is also the reason for the excellent impulse noise immunity of the back porch output as shown in Figure 4-2.

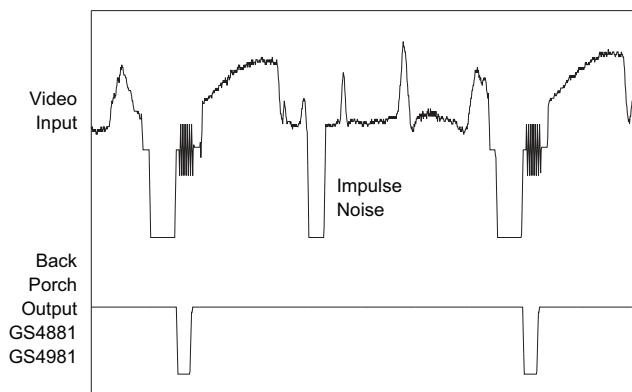

Figure 4-2: Back Porch Noise Immunity

The GS1881 does not gate the Back Porch which allows for total pin compatibility with the LM1881.

4.3 Vertical Sync Output (Pin 3)

The vertical sync interval is detected by integrating the composite sync pulses. The first broad vertical sync pulse causes an internal capacitor to charge past a fixed threshold and raises an internal vertical flag. Once the vertical flag is raised, the positive edge of the next serration clocks out the vertical output. When the vertical sync interval ends, the first post equalizing pulse is unable to charge the capacitor sufficiently, causing the internal vertical flag to go high. The rising edge of the second post-equalizing pulse then clocks out the high flag to end the vertical sync pulse. The vertical output is clocked in and out and therefore is a fixed width of $197.7\mu\text{s}$ ($3H + 4.7\mu\text{s} + 2.3\mu\text{s}$). In the case of a non-standard vertical interval that has no serrations, a second internal capacitor is charged and clocks the vertical pulse out after typically $65\mu\text{s}$. In this case the end of the vertical pulse will still be the rising edge of the second post-equalizing pulse. As the vertical detector is designed as a true integrator, it provides improved noise immunity.

4.4 Odd/Even Field Output (Pin 7 GS1881, GS4881)

NTSC PAL and SECAM composite video standards are interlaced video schemes and therefore have odd and even fields. For odd fields the first broad vertical sync pulse is coincident with the start of horizontal, while for even fields the first broad vertical sync pulse starts in the middle of a horizontal line. Therefore by comparing the vertical sync with an internally generated horizontal sync the odd/even field information is determined. This output is clocked out by the falling edge of vertical sync. The odd/even output is low during even fields and high during odd fields. This method of detecting odd and even fields is very noise tolerant.

Noise during the pre-equalizing pulses does not affect the output since the field decision is made at the beginning of the vertical interval. This noise immunity is displayed in Figure 4-3 in which an extra pre-equalizing pulse has been added to the video input with no negative effect on the odd/even field information.

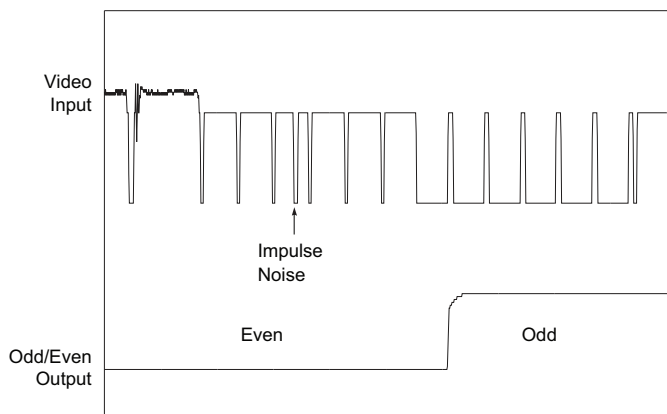

Figure 4-3: Odd/Even Output

4.5 Horizontal Output (Pin 7 GS4981)

As mentioned above, the odd/even field output of the GS1881 and GS4881 is generated by comparing vertical sync with an internal horizontal sync signal. This horizontal sync signal is a true horizontal signal (i.e. maintained during the vertical interval) and is outputted on Pin 7 for the GS4981. A delay of 190ns from the video input and a width of 6.5µs are typically characteristics for this signal. The windowing circuit which generates horizontal provides excellent impulse noise immunity as shown in Figure 4-4. This output buffer is an open collector stage with an internal 10kΩ pull up resistor.

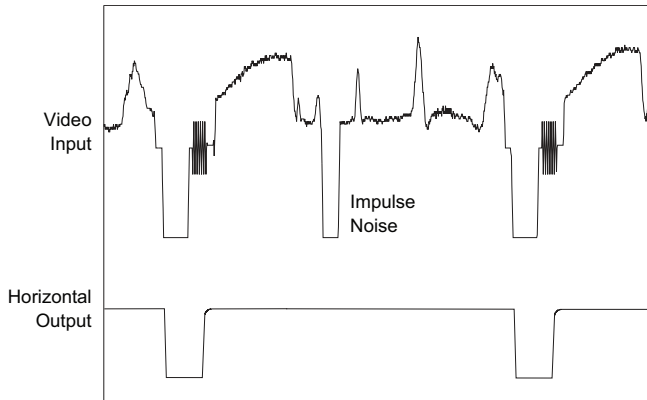

Figure 4-4: Horizontal Output

4.6 Block Diagrams

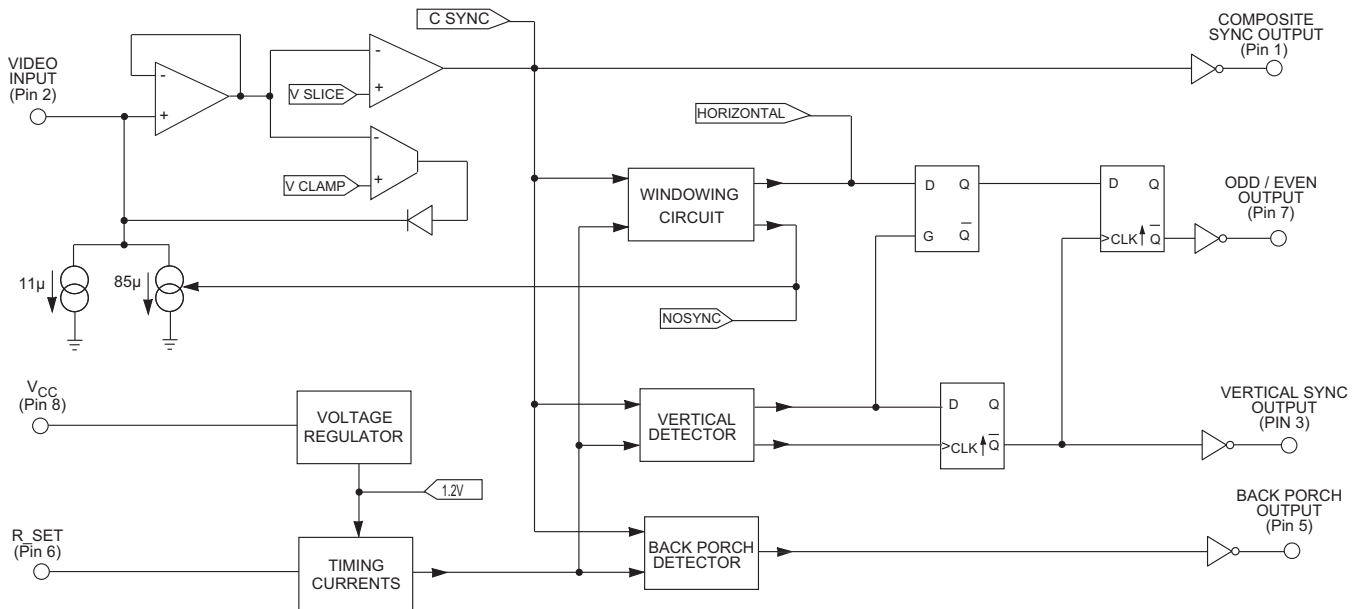

Figure 4-5: GS1881 Block Diagram

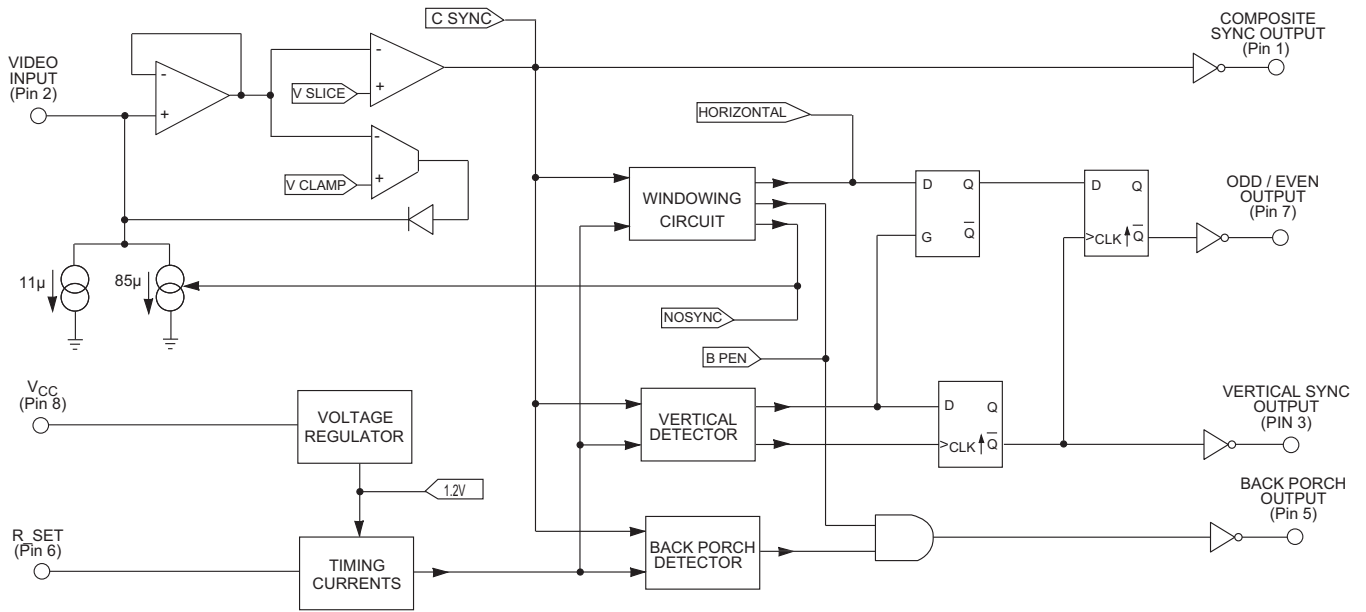

Figure 4-6: GS4881 Block Diagram

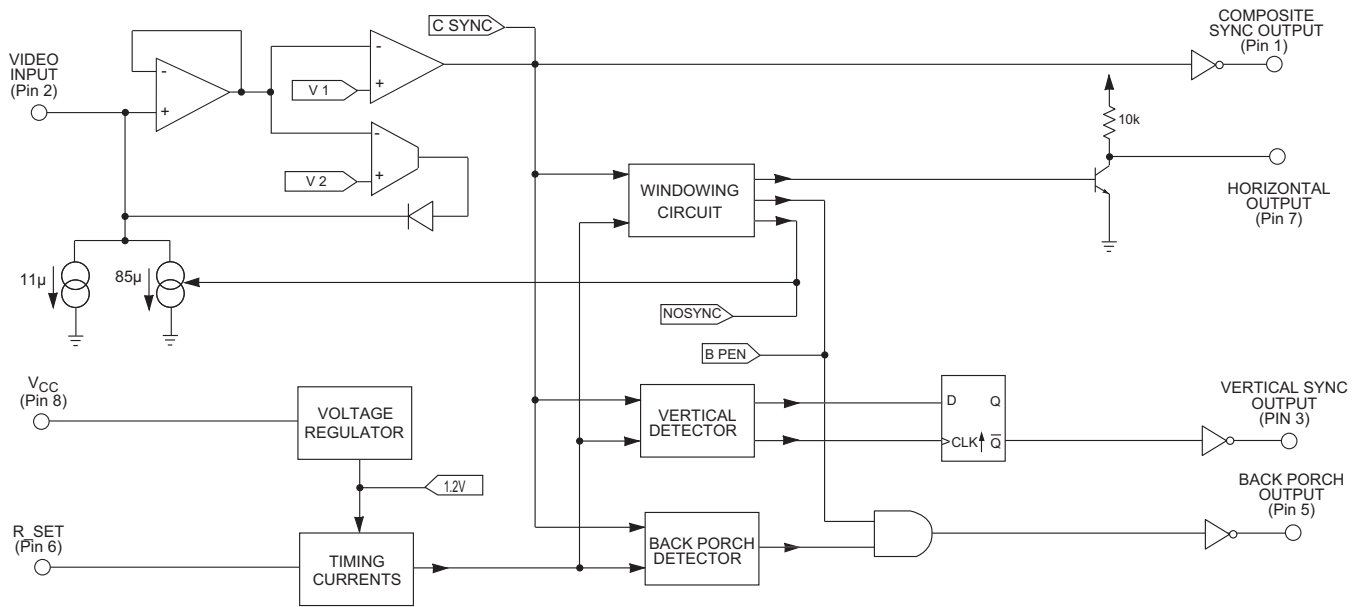

Figure 4-7: GS4981 Block Diagram

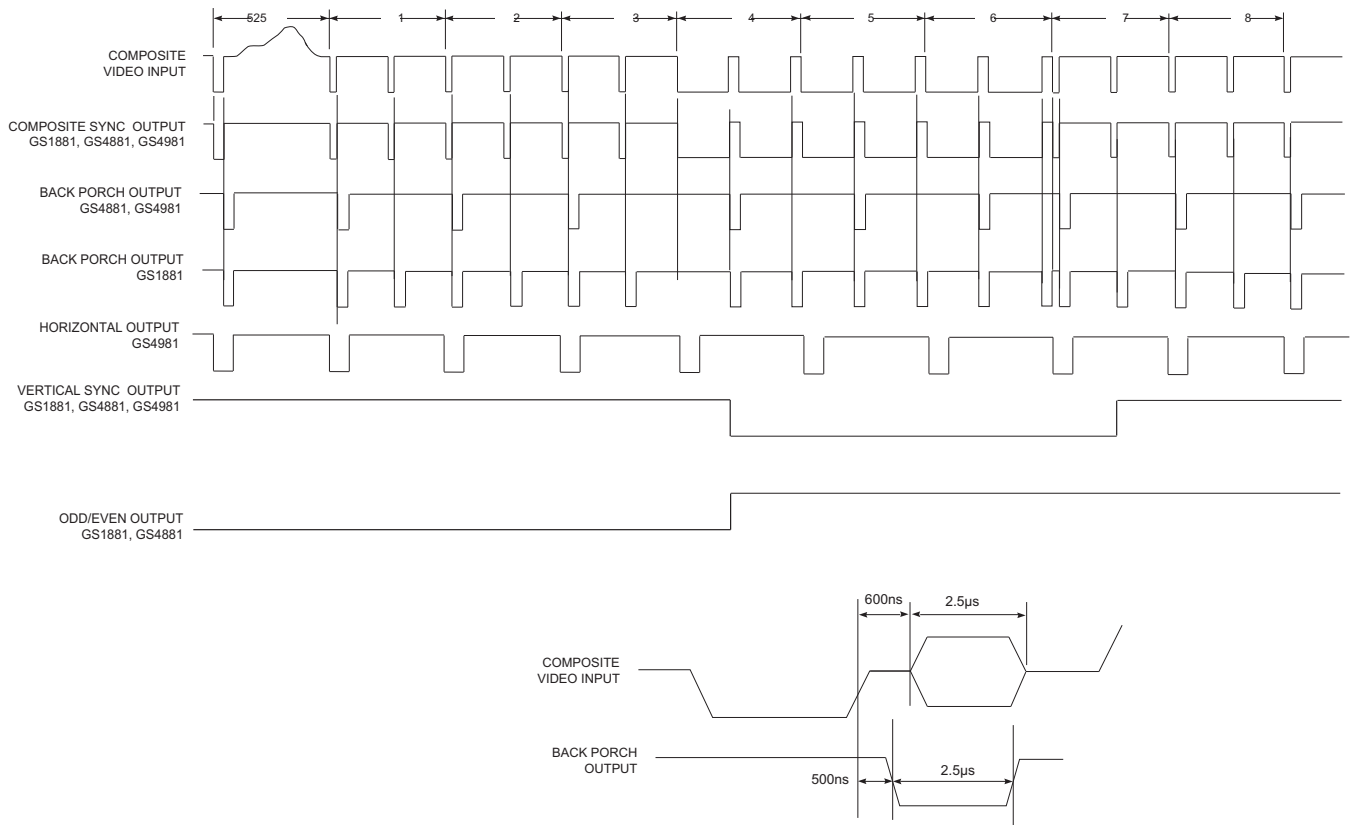

Figure 4-8: GS1881, GS4881, GS4981 Video Sync Separator Timing Diagram

5. Application Notes

5.1 Choosing the Appropriate Input Capacitor to Optimize Slicing Level and Hum Rejection

The video designer can adjust the slicing level by choosing the value of the input coupling capacitor. The relationship between slicing level and input coupling capacitor is described by the following equation:

$$\Delta V_{\text{SLICE}} = \frac{I_{\text{DIS}}}{C_C} \Delta T = V_{\text{DROOP}}$$

where: I_{DIS} = clamp discharge current = 11 μA
 $\Delta T = T_{\text{LINE}} - T_{\text{SYNC}} = (63.5 \mu\text{s} - 4.7 \mu\text{s})$
 C_C = input coupling capacitor

Figure 5-1 is a graphical representation of this equation and Figure 5-2 and Figure 5-3 show the input video waveforms for 0.1 μF and 0.01 μF input capacitors respectively. The advantage in choosing a smaller input coupling capacitor, is increased hum rejection as the following analyses illustrates.

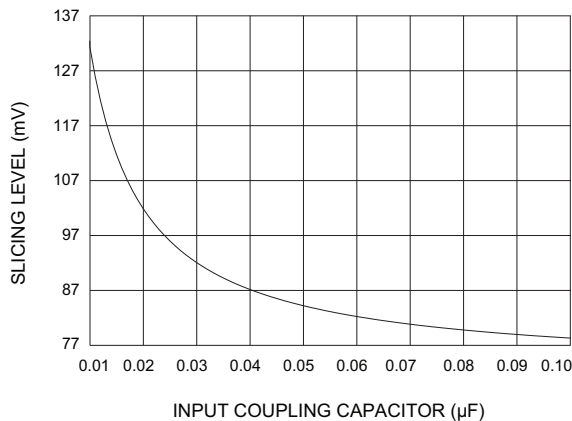

Figure 5-1: Slicing Level vs Input Coupling Capacitor

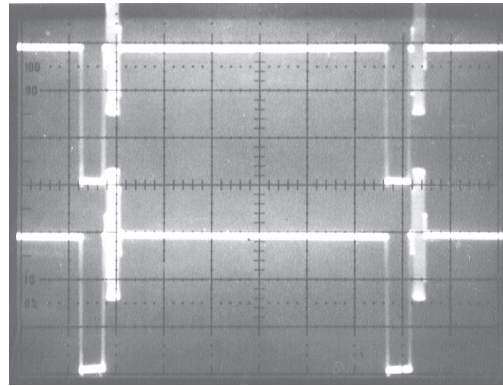
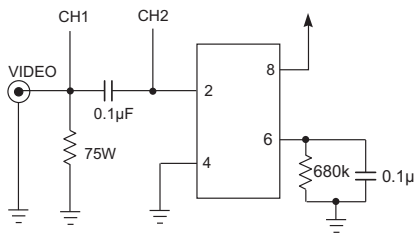

Figure 5-2: Test Circuit 1 and Video Waveforms for 0.1μF

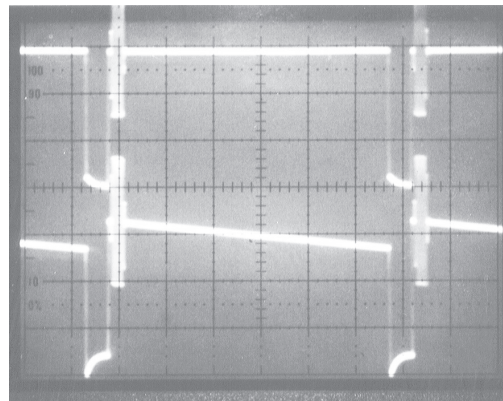
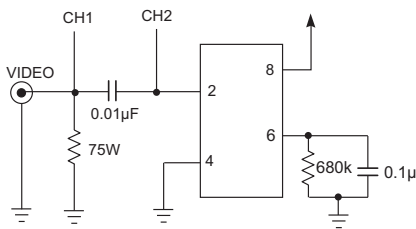

Figure 5-3: Test Circuit 2 and Video Waveforms for 0.01μF

The interfering hum component is defined by:

$$v_{\text{HUM}}(t) = V_p \cos(2\pi f_{\text{HUM}} t)$$

where: V_p = Peak voltage of AC hum

f_{HUM} = Frequency of hum (50Hz or 60Hz)

The maximum rate of change of this hum signal occurs at the zero crossing points and is:

$$\left. \frac{dv_{\text{HUM}}}{dt} \right|_{t = \frac{\pi}{2}, \frac{3\pi}{2}} = \pm V_p 2\pi f_{\text{HUM}}$$

Since the horizontal scan period is much faster than the period of the interference ($63.5\text{ms} \ll 1/f_{\text{HUM}}$) a good approximation is to assume that the maximum line to line voltage change resulting from the interfering hum is:

$$\Delta V_{\text{HUM}} = \pm V_p 2\pi f_{\text{HUM}} T_{\text{LINE}}$$

where: $T_{\text{LINE}} = 63.5\mu\text{s}$

The total line to line voltage change (ΔV_T) can then be calculated by adding the hum component (ΔV_{HUM}) and the droop component (V_{DROOP}). This calculation results in two cases:

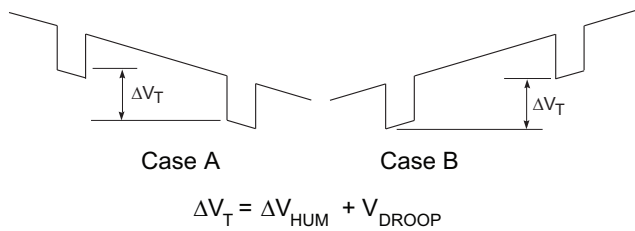

To correct for ΔV_T in case A, the input stage must be able to charge the input capacitor ΔV_T volts in $4.7\mu s$. This is not a constraint as the typical clamping current of $650\mu A$ can accomplish this for practical values of coupling capacitor.

The only way to compensate for ΔV_T in case B is to make $V_{DROOP} > \Delta V_{HUM}$. V_{DROOP} is increased by decreasing the input coupling capacitor value. Therefore the video designer can increase hum rejection by decreasing the value of this capacitor. The following is a numerical example:

choosing $C_C = 0.022\mu F$

$$\therefore V_{DROOP} = \frac{11}{0.022} (63.5\mu - 4.7\mu) = 29.4mV$$

the maximum amount of 60 Hz hum that could be rejected would be when:

$$\Delta V_{DROOP} = \Delta V_{HUM} = V_P 2\pi f_{HUM} T_{LINE}$$

$$\therefore V_P = \frac{\Delta V_{DROOP}}{2\pi f_{HUM} T_{LINE}} = \frac{29.4mV}{2\pi(60)(63.5\mu)} = 1.23V_{PEAK} \text{ HUM}$$

verifying that there is enough clamping current

$$\Delta V_t = 29.4mV + 29.4mV = 58.8mV$$

$$\therefore i = 0.022\mu \left(\frac{58.8mV}{4.7\mu} \right) = 275\mu A$$

which is less than $650\mu A$.

5.2 Filtering

In order to keep the input to output delay small and temperature stable, no chrominance filtering is done within the device. External filtering may be necessary if the input signal contains large chrominance components (less than $77mV$ from sync tip) or has significant amounts of high frequency noise. This filter can be a simple low pass RC network constructed by a resistance (R_S) in series with the source and a capacitor (C_f) to ground. A single pole low pass filter having a corner frequency of approximately $500kHz$ will provide ample bandwidth for passing sync pulses with almost $18dB$ attenuation at $3.58MHz$. Care should be taken in choosing the value of the series resistor in the filter since the source resistance seen by the sync separator affects its performance. See [Figure 5-4](#).

As the source resistance rises, the video input sync tip starts to be clipped due to the clamping current during the sync. This clamping current is relatively large due to the non-symmetric duty cycle of video. To a good approximation the amount of sync clamp current can be calculated as follows:

$$\begin{aligned}
 (I_{CLAMP_AVG})(T_{SYNC}) &= (I_{DIS})(T_{LINE} - T_{SYNC}) \\
 I_{CLAMP_AVG}(4.7\ \mu s) &= (11\ \mu A)(63.5\ \mu s - 4.7\ \mu s) \\
 \therefore I_{CLAMP_AVG} &= 137.6\ \mu A
 \end{aligned}$$

This clamp current flows in the source resistance causing a voltage drop equal to:

$$\begin{aligned}
 V_{CLIP} &= (I_{CLAMP_AVG})(R_S) \\
 &= (137.6\ \mu)(R_S)
 \end{aligned}$$

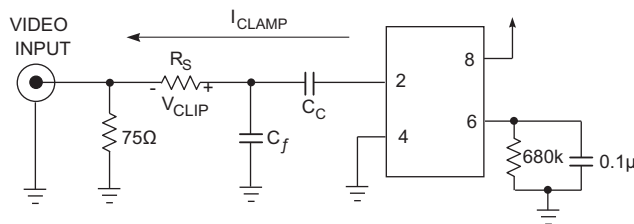

Figure 5-4: Simple Chrominance Filtering

Figure 5-5 shows the amount of sync clipping for a 560Ω source resistor. A graph of V_{CLIP} versus R_S is shown in Figure 5-6, and Figure 5-7 shows the corresponding capacitor value for a particular series resistor to provide a corner frequency of 500kHz.

In applications where signal levels are small the amount of attenuation should be minimized. It follows from Figure 5-6 and Figure 5-7 that in order to minimize attenuation a small series resistor and a larger capacitor to ground should be chosen. This however, increases the capacitive loading of the signal source.

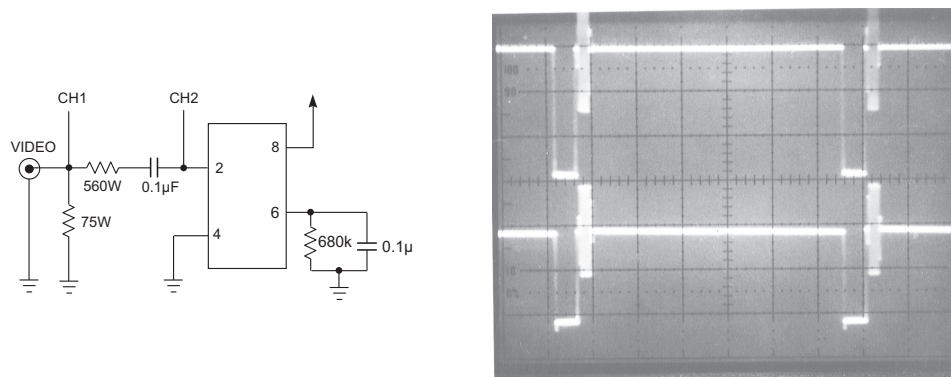

Figure 5-5: Test Circuit 3 and Sync Clipping for a 650Ω Source Resistor

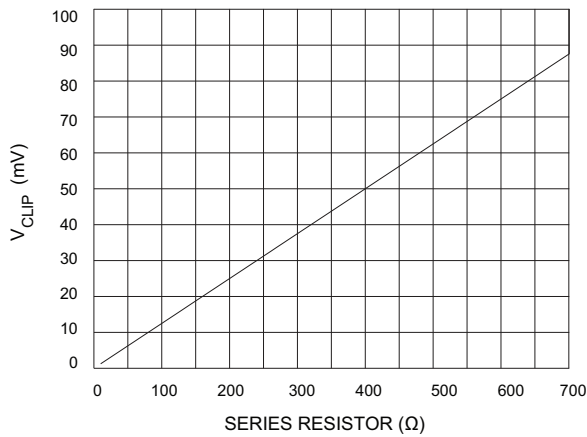

Figure 5-6: V_{CLIP} vs Series Resistor

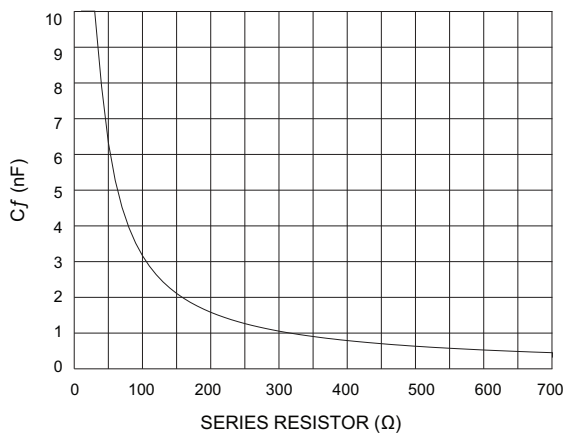

Figure 5-7: C_f vs Series Resistor

Another way to minimize the amount of attenuation is to control the source resistance seen by the sync separator by using a PNP emitter follower (Figure 5-8). A PNP emitter follower works well to drive the sync separator, and does not require much DC current because the transistor provides the current when it is needed during sync. Figure 5-9 is a typical application circuit that minimizes sync tip clipping.

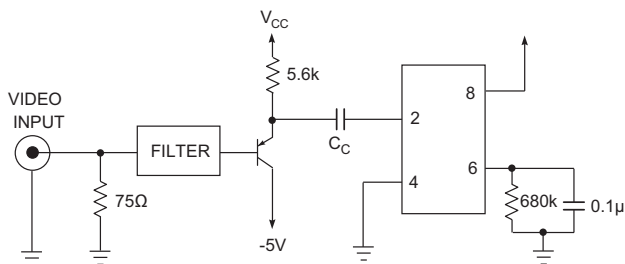

Figure 5-8: PNP Emitter Follower Buffer

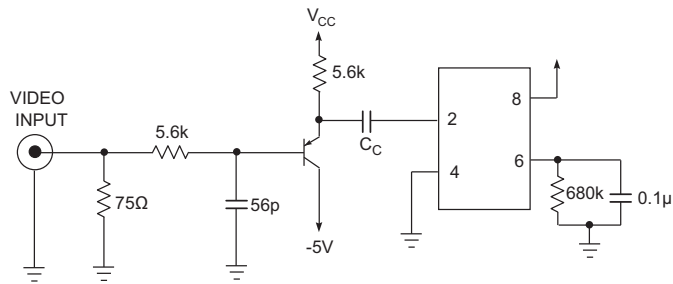

Figure 5-9: Typical NTSC Application Circuit

5.3 Deriving Odd/Even Using the GS4981

Odd/even field information can be derived using the vertical and horizontal outputs from the GS4981 along with an external positive edge D flip/flop. The horizontal output is used as the D input and the vertical output as the clock, as shown in Figure 5-10.

At the start of an odd field the vertical output ends in the middle of the horizontal line and a high will be latched. At the start of an even field, the vertical output ends near the beginning of the horizontal line and since the horizontal output is low, a low will be latched. This timing sequence is shown in Figure 5-11.

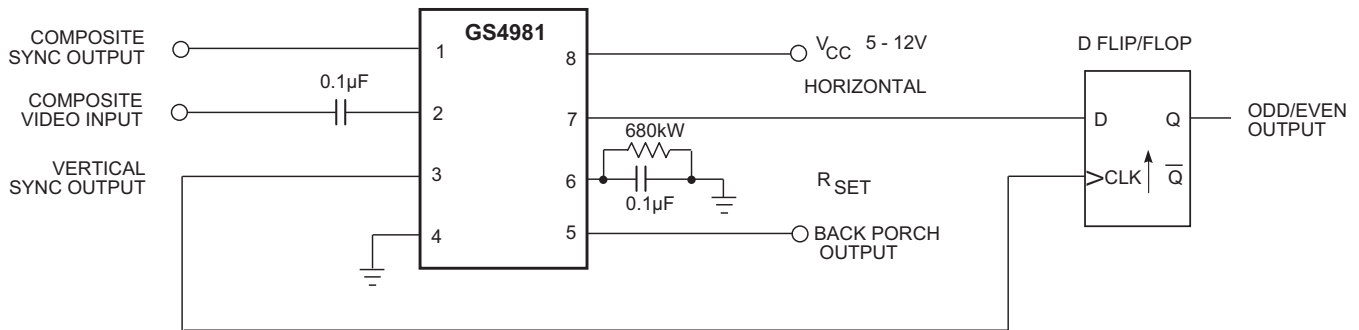

Figure 5-10: Derivation of Odd/Even with GS4981

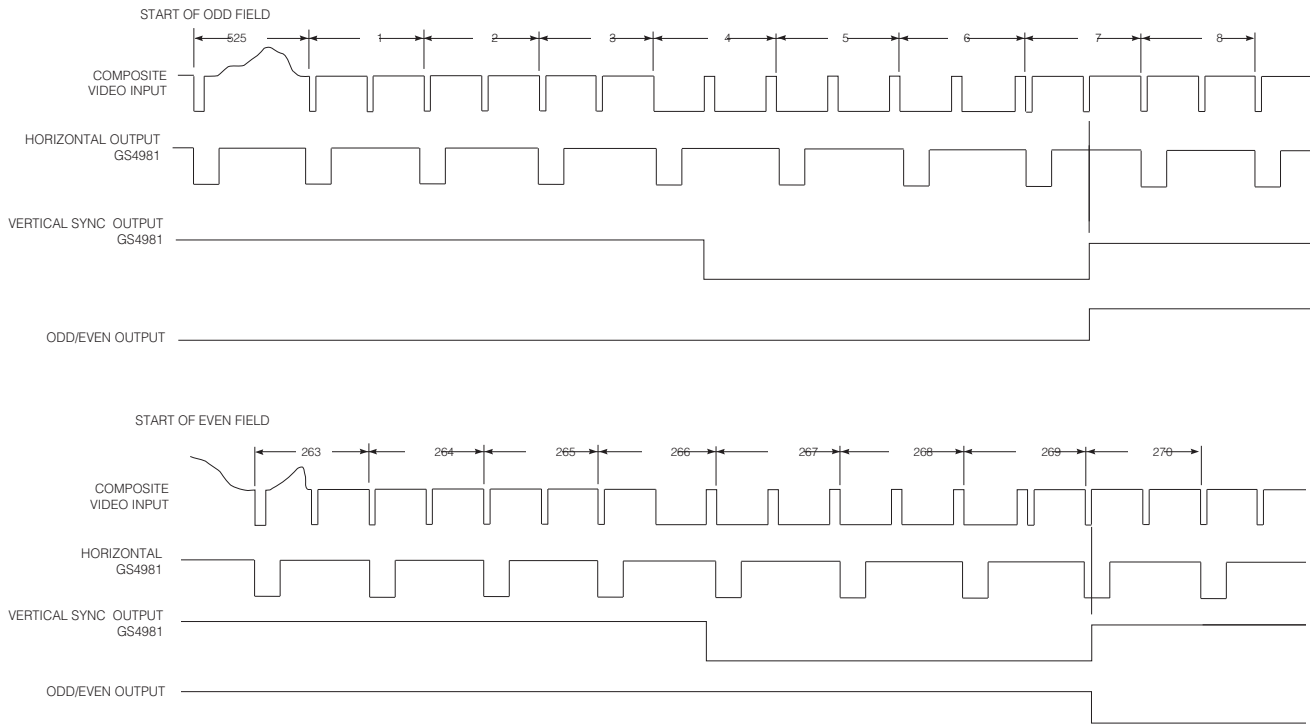

Figure 5-11: Timing Diagram

6. Ordering Information

6.1 GS1881 Ordering Information

Table 6-1: GS1881 Ordering Information

Part Number	Package Type	Temperature Range	Pb-Free and Green
GS1881 - CDA	8-Pin PDIP	0°C to 70°C	No
GS1881 - CKA	8-Pin SOIC	0°C to 70°C	No
GS1881 - CTA	8-Pin TAPE	0°C to 70°C	No
GS1881 - IDA	8-Pin PDIP	-25°C to 85°C	No
GS1881 - IKA	8-Pin SOIC	-25°C to 85°C	No
GS1881 - ITA	8-Pin TAPE	-25°C to 85°C	No
GS1881 - CKAE3	8-Pin SOIC	0°C to 70°C	Yes
GS1881 - CTAE3	8-Pin TAPE	0°C to 70°C	Yes
GS1881 - IKA E3	8-Pin SOIC	-25°C to 85°C	Yes

6.2 GS4881 Ordering Information

Table 6-2: GS4881 Ordering Information

Part Number	Package Type	Temperature Range	Pb-Free and Green
GS4881 - CDA	8-Pin PDIP	0°C to 70°C	No
GS4881 - CKA	8-Pin SOIC	0°C to 70°C	No
GS4881 - CTA	8-Pin TAPE	0°C to 70°C	No
GS4881 - IDA	8-Pin PDIP	-25°C to 85°C	No
GS4881 - IKA	8-Pin SOIC	-25°C to 85°C	No
GS4881 - ITA	8-Pin TAPE	-25°C to 85°C	No
GS4881 - CKAE3	8-Pin SOIC	0°C to 70°C	Yes
GS4881 - CDAE3	8-Pin PDIP	0°C to 70°C	Yes

6.3 GS4981 Ordering Information

Table 6-3: GS4981 Ordering Information

Part Number	Package Type	Temperature Range	Pb-Free and Green
GS4981 - CDA	8-Pin PDIP	0°C to 70°C	No
GS4981 - CKA	8-Pin SOIC	0°C to 70°C	No
GS4981 - CTA	8-Pin TAPE	0°C to 70°C	No
GS4981 - IDA	8-Pin PDIP	-25°C to 85°C	No
GS4981 - IKA	8-Pin SOIC	-25°C to 85°C	No
GS4981 - CKAE3	8-Pin SOIC	0°C to 70°C	Yes
GS4981 - CTAE3	8-Pin TAPE	0°C to 70°C	Yes
GS4981 - IKAE3	8-Pin SOIC	-25°C to 85°C	Yes

**DOCUMENT IDENTIFICATION
DATA SHEET**

The product is in production. Genum reserves the right to make changes to the product at any time without notice to improve reliability, function or design, in order to provide the best product possible.

CAUTION

ELECTROSTATIC SENSITIVE DEVICES
DO NOT OPEN PACKAGES OR HANDLE EXCEPT AT A
STATIC-FREE WORKSTATION



GENNUM CORPORATE HEADQUARTERS

4281 Harvester Road, Burlington, Ontario L7L 5M4 Canada

Phone: +1 (905) 632-2996

E-mail: corporate@gennum.com

Fax: +1 (905) 632-2055

www.gennum.com

OTTAWA

232 Herzberg Road, Suite 101
Kanata, Ontario K2K 2A1
Canada

Phone: +1 (613) 270-0458

Fax: +1 (613) 270-0429

CALGARY

3553 - 31st St. N.W., Suite 210
Calgary, Alberta T2L 2K7
Canada

Phone: +1 (403) 284-2672

UNITED KINGDOM

North Building, Walden Court
Parsonage Lane,
Bishop's Stortford Hertfordshire, CM23 5DB
United Kingdom

Phone: +44 1279 714170

Fax: +44 1279 714171

INDIA

#208(A), Nirmala Plaza,
Airport Road, Forest Park Square
Bhubaneswar 751009
India

Phone: +91 (674) 653-4815

Fax: +91 (674) 259-5733

SNOWBUSH IP - A DIVISION OF GENNUM

439 University Ave. Suite 1700
Toronto, Ontario M5G 1Y8
Canada

Phone: +1 (416) 925-5643

Fax: +1 (416) 925-0581

E-mail: sales@snowbush.com

Web Site: <http://www.snowbush.com>

MEXICO

288-A Paseo de Maravillas
Jesus Ma., Aguascalientes
Mexico 20900

Phone: +1 (416) 848-0328

JAPAN KK

Shinjuku Green Tower Building 27F
6-14-1, Nishi Shinjuku
Shinjuku-ku, Tokyo, 160-0023
Japan

Phone: +81 (03) 3349-5501

Fax: +81 (03) 3349-5505

E-mail: gennum-japan@gennum.com

Web Site: <http://www.gennum.co.jp>

TAIWAN

6F-4, No.51, Sec.2, Keelung Rd.
Sinyi District, Taipei City 11502
Taiwan R.O.C.

Phone: (886) 2-8732-8879

Fax: (886) 2-8732-8870

E-mail: gennum-taiwan@gennum.com

GERMANY

Hainbuchenstraße 2
80935 Muenchen (Munich), Germany

Phone: +49-89-35831696

Fax: +49-89-35804653

E-mail: gennum-germany@gennum.com

NORTH AMERICA WESTERN REGION

691 South Milpitas Blvd., Suite #200
Milpitas, CA 95035
United States

Phone: +1 (408) 934-1301

Fax: +1 (408) 934-1029

E-mail: naw_sales@gennum.com

NORTH AMERICA EASTERN REGION

4281 Harvester Road
Burlington, Ontario L7L 5M4
Canada

Phone: +1 (905) 632-2996

Fax: +1 (905) 632-2055

E-mail: nae_sales@gennum.com

KOREA

8F Jinnex Lakeview Bldg.
65-2, Bangidong, Songpagu
Seoul, Korea 138-828

Phone: +82-2-414-2991

Fax: +82-2-414-2998

E-mail: gennum-korea@gennum.com

Genum Corporation assumes no liability for any errors or omissions in this document, or for the use of the circuits or devices described herein. The sale of the circuit or device described herein does not imply any patent license, and Genum makes no representation that the circuit or device is free from patent infringement.

All other trademarks mentioned are the properties of their respective owners.

GENNUM and the Genum logo are registered trademarks of Genum Corporation.

© Copyright 1991 Genum Corporation. All rights reserved.

www.gennum.com

X-ON Electronics

Largest Supplier of Electrical and Electronic Components

Click to view similar products for [Logarithmic Amplifiers](#) category:

Click to view products by [Semtech](#) manufacturer:

Other Similar products are found below :

[MAX4207ETE+](#) [TL441MNSREP](#) [TL441CNSR](#) [5962-9864601QEA](#) [AD606JNZ](#) [AD606JRZ](#) [AD640BE](#) [AD640BPZ](#) [AD640JNZ](#) [AD640JPZ](#)
[AD640TD/883B](#) [AD641ANZ](#) [AD641APZ](#) [AD8304ARUZ](#) [AD8304ARUZ-RL7](#) [AD8305ACPZ-RL7](#) [AD8306ARZ](#) [AD8307ANZ](#)
[AD8307ARZ](#) [AD8307ARZ-REEL](#) [AD8307ARZ-RL7](#) [AD8309ARUZ](#) [AD8309ARUZ-REEL7](#) [AD8310ARMZ](#) [AD8310ARMZ-REEL7](#)
[AD8313ARMZ](#) [AD8314ACPZ-RL7](#) [AD8314ARM](#) [AD8314ARMZ](#) [AD8314ARMZ-REEL7](#) [AD8317ACPZ-R7](#) [AD8318ACPZ-REEL7](#)
[ADL5303ACPZ-R7](#) [ADL5304ACPZ-R7](#) [ADL5310ACPZ-REEL7](#) [ADL5315ACPZ-R7](#) [ADL5513ACPZ-R7](#) [ADL5519ACPZ-R7](#)
[MAX4206ETE+](#) [MAX4206ETE+T](#) [GS2985-INE3](#) [LOG104AIDE4](#) [LOG101AID](#) [LOG101AIDE4](#) [LOG104AID](#) [LOG112AID](#)
[LOG112AIDE4](#) [LOG114AIRGVT](#) [LOG2112AIDW](#) [LOG102AID](#)