

MM1Z5221B~MM1Z5267B-AH

SILICON PLANAR ZENER DIODES

Features

- AEC-Q101 Qualified
- Total power dissipation: Max. 500 mW
- Small plastic package suitable for surface mounted design
- Tolerance approximately $\pm 5\%$
- Halogen and Antimony Free(HAF), RoHS compliant

PINNING

PIN	DESCRIPTION
1	Cathode
2	Anode

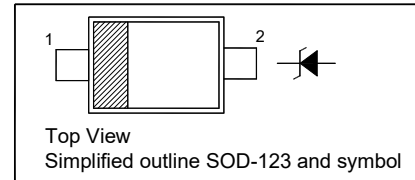

Absolute Maximum Ratings ($T_a = 25^\circ\text{C}$)

Parameter	Symbol	Value	Unit
Power Dissipation $T_L = 75^\circ\text{C}^{1)}$	P_{tot}	500	mW
Junction Temperature	T_j	150	$^\circ\text{C}$
Storage Temperature Range	T_{stg}	- 55 to + 150	$^\circ\text{C}$

Characteristics at $T_a = 25^\circ\text{C}$

Parameter	Symbol	Max.	Unit
Thermal Resistance Junction to Ambient ²⁾	$R_{\theta\text{JA}}$	340	$^\circ\text{C}/\text{W}$
Thermal Resistance Junction to Lead ²⁾	$R_{\theta\text{JL}}$	150	$^\circ\text{C}/\text{W}$
Forward Voltage at $I_F = 10 \text{ mA}$	V_F	0.9	V

¹⁾ FR-4 PCB = 89 * 38 mm.

²⁾ Mounted on an FR-4 PCB 38 * 38 * 1.6 mm with single-sided Cu pad areas 25mm²(>70 μm thick).

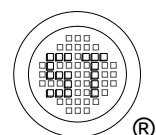

MM1Z5221B~MM1Z5267B-AH

Characteristics at $T_a = 25^\circ\text{C}$

Type	Marking Code	Zener Voltage Range ¹⁾				Dynamic Impedance ²⁾				Reverse Current	
		V _{znom} V	V _{ZT}		at I _{ZT}	Z _{ZT}	at I _{ZT}	Z _{ZK}	at I _{ZK}	I _R	at V _R
			Min. (v)	Max.(v)	(mA)	Max. (Ω)	(mA)	Max. (Ω)	(mA)	Max.(μA)	(V)
MM1Z5221B	A4	2.4	2.28	2.52	20	30	20	1200	0.25	100	1
MM1Z5223B	B4	2.7	2.57	2.84	20	30	20	1300	0.25	75	1
MM1Z5225B	C4	3.0	2.85	3.15	20	29	20	1600	0.25	50	1
MM1Z5226B	D4	3.3	3.14	3.47	20	28	20	1600	0.25	25	1
MM1Z5227B	E4	3.6	3.42	3.78	20	24	20	1700	0.25	15	1
MM1Z5228B	F4	3.9	3.71	4.1	20	23	20	1900	0.25	10	1
MM1Z5229B	H4	4.3	4.09	4.52	20	22	20	2000	0.25	5	1
MM1Z5230B	J4	4.7	4.47	4.94	20	19	20	1900	0.25	5	2
MM1Z5231B	K4	5.1	4.85	5.36	20	17	20	1600	0.25	5	2
MM1Z5232B	M4	5.6	5.32	5.88	20	11	20	1600	0.25	5	3
MM1Z5234B	N4	6.2	5.89	6.51	20	7	20	1000	0.25	5	4
MM1Z5235B	P4	6.8	6.46	7.14	20	5	20	750	0.25	3	5
MM1Z5236B	R4	7.5	7.13	7.88	20	6	20	500	0.25	3	6
MM1Z5237B	X4	8.2	7.79	8.61	20	8	20	500	0.25	3	6.5
MM1Z5239B	Y4	9.1	8.65	9.56	20	10	20	600	0.25	3	7
MM1Z5240B	Z4	10	9.50	10.5	20	17	20	600	0.25	3	8
MM1Z5241B	A5	11	10.45	11.55	20	22	20	600	0.25	2	8.4
MM1Z5242B	B5	12	11.40	12.6	20	30	20	600	0.25	1	9.1
MM1Z5243B	C5	13	12.35	13.65	9.5	13	9.5	600	0.25	0.5	9.9
MM1Z5245B	D5	15	14.25	15.75	8.5	16	8.5	600	0.25	0.1	11
MM1Z5246B	E5	16	15.20	16.8	7.8	17	7.8	600	0.25	0.1	12
MM1Z5247B	G5	17	16.15	17.85	7.4	19	7.4	600	0.25	0.1	13
MM1Z5248B	F5	18	17.10	18.9	7	21	7	600	0.25	0.1	14
MM1Z5249B	K9	19	18.05	19.95	6.6	23	6.6	600	0.25	0.1	14
MM1Z5250B	H5	20	19.00	21	6.2	25	6.2	600	0.25	0.1	15
MM1Z5251B	J5	22	20.90	23.1	5.6	29	5.6	600	0.25	0.1	17
MM1Z5252B	K5	24	22.80	25.2	5.2	33	5.2	600	0.25	0.1	18
MM1Z5253B	M9	25	23.75	26.25	5	35	5	600	0.25	0.1	19
MM1Z5254B	M5	27	25.65	28.35	4.6	41	4.6	600	0.25	0.1	21
MM1Z5256B	N5	30	28.50	31.5	4.2	49	4.2	600	0.25	0.1	23
MM1Z5257B	P5	33	31.35	34.65	3.8	58	3.8	700	0.25	0.1	25
MM1Z5258B	R5	36	34.20	37.8	3.4	70	3.4	700	0.25	0.1	27
MM1Z5259B	X5	39	37.05	40.95	3.2	80	3.2	800	0.25	0.1	30
MM1Z5260B	Y5	43	40.85	45.15	3	93	3	900	0.25	0.1	33
MM1Z5261B	Z5	47	44.65	49.35	2.7	105	2.7	1000	0.25	0.1	36
MM1Z5262B	A6	51	48.45	53.55	2.5	125	2.5	1100	0.25	0.1	39
MM1Z5263B	B6	56	53.20	58.8	2.2	150	2.2	1300	0.25	0.1	43
MM1Z5265B	C6	62	58.90	65.1	2	185	2	1400	0.25	0.1	47
MM1Z5266B	D6	68	64.60	71.4	1.8	230	1.8	1600	0.25	0.1	52
MM1Z5267B	E6	75	71.25	78.75	1.7	270	1.7	1700	0.25	0.1	56

¹⁾ V_{ZT} is tested with pulses (20 ms)

²⁾ Z_{ZT} and Z_{ZK} are measured by dividing the AC voltage drop across the device by the AC current applied. The specified limits are for I_{Z(AC)} = 0.1 I_{Z(DC)} with the AC frequency = 1 KHz.

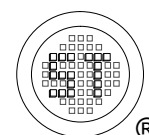

MM1Z5221B~MM1Z5267B-AH

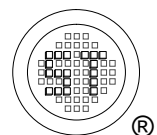
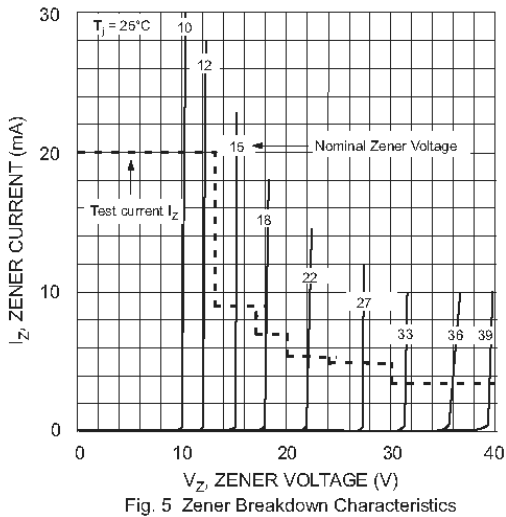
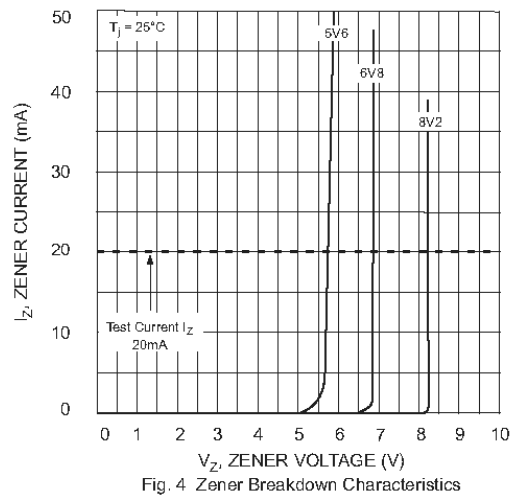
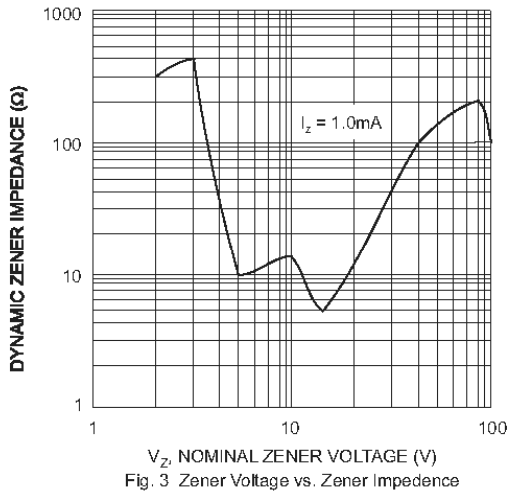
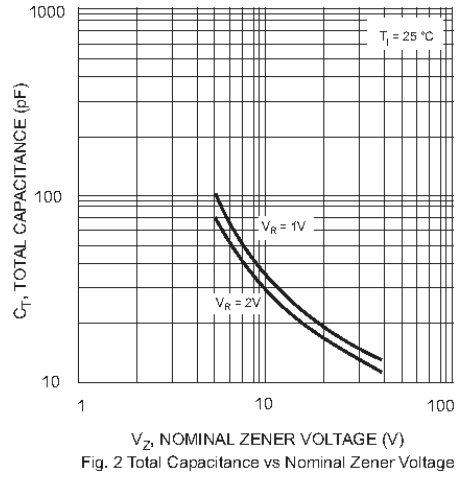
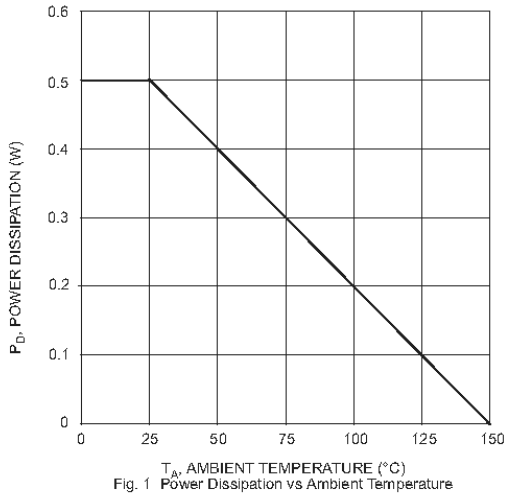

MM1Z5221B~MM1Z5267B-AH

PACKAGE OUTLINE

Plastic surface mounted package; 2 leads

SOD-123

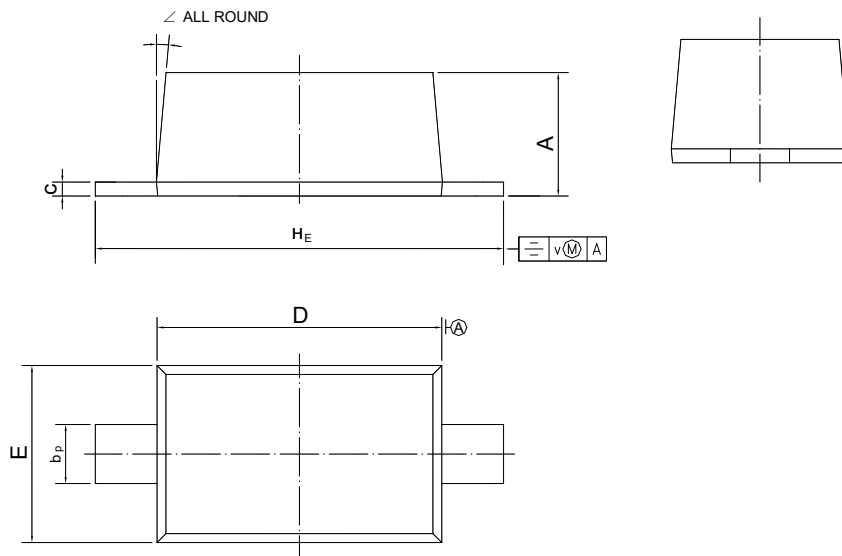

UNIT	A	b _p	c	D	E	H _E	v	∠
mm	1.15 1.05	0.6 0.5	0.135 0.100	2.7 2.6	1.65 1.55	3.85 3.55	0.2	5°

Recommended Soldering Footprint

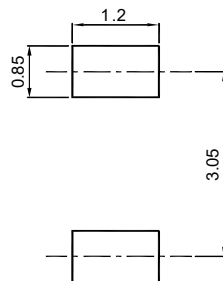

Packing information

Package	Tape Width (mm)	Pitch		Reel Size		Per Reel Packing Quantity
		mm	(inch)	mm	(inch)	
SOD-123	8	4 ± 0.1	0.157 ± 0.004	178	7	3,000

Marking information

" III " = Cathode line

" ** " = Part No.

" • " = HAF (Halogen and Antimony Free)

Font type: Arial

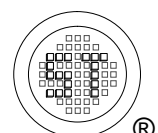
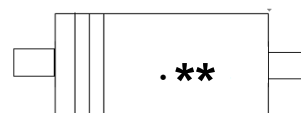

X-ON Electronics

Largest Supplier of Electrical and Electronic Components

Click to view similar products for [Zener Diodes](#) category:

Click to view products by [Semtech](#) manufacturer:

Other Similar products are found below :

[RKZ13B2KG#P1](#) [DL5234B](#) [EDZTE6113B](#) [1N4682](#) [1N4693](#) [1N4732A](#) [1N4736A](#) [1N4750A](#) [1N4759ARL](#) [1N5241B](#) [1N5365B](#) [1N5369B](#)
[1N747A](#) [1N964B](#) [1N966B](#) [1N968B](#) [1N972B](#) [JANS1N4974US](#) [JANTX1N5907](#) [1N4692](#) [1N4700](#) [1N4702](#) [1N4704](#) [1N4711](#) [1N4714](#)
[1N4745ARL](#) [1N4752ARL](#) [1N4760ARL](#) [1N5221B](#) [1N5242BTR](#) [1N5350B](#) [1N5352B](#) [1N961BRR1](#) [1N964BRL](#) [RKZ5.1BKU#P6](#)
[3SMAJ5946B-TP](#) [3SMAJ5950B-TP](#) [3SMBJ5925B-TP](#) [MMSZ5230BQ-13-F](#) [MMSZ5232BQ-13-F](#) [BZX84C7V5](#) [3SMAJ5945B-TP](#)
[3SMAJ5947B-TP](#) [3SMBJ5941B-TP](#) [DL4732A-T3](#) [DZ2S240M0L](#) [SMAZ27-TP](#) [ZMM5224B-7](#) [RD16UM-T1-A](#) [RD39S-T1-A](#)